

# RADIO CRAFT

*In this issue -*

BETATRON -  
Atom Smasher

RADAR -  
Weapon for Peace



**RADAR SEARCHLIGHT  
AND GUN CONTROL**  
SEE PAGE 90

14BUR6

**NOV**  
1945

**25c**  
CANADA 30c

**RADIO-ELECTRONICS IN ALL ITS PHASES**



# PRECISION is a hobby in MT. CARMEL, ILL.

Yes, precision is the hobby of the men and women who make up Meissner's famed "*precision-el*." The high quality electronic equipment that their skilled fingers produce each day is proof enough that they enjoy the work as thoroughly as they enjoy their after-hours hobbies. You'll find more proof in the photographs on this page.



This "*precisioneer*" takes the same interest in his work at Meissner as he does in his home. He proves it with a smile that is typical of *precision-el* — as typical as the precision quality of Meissner products.



Here's a member of Meissner's *precision-el* whose smile is contagious. Delicate adjustments properly made are the reason. Higher quality in Meissner electronic equipment is the result!



It could be a new grandson or a 3-pound bass that brings a smile like this, but it's not! It's pride in a precision electronic job well done. It's a reason for higher quality in Meissner products.



Baseball broadcast? Not on your life. But it's a "homer" for this member of Meissner's laboratory staff. The satisfied smile means that the instrument he's testing is "on the Meissner quality beam."

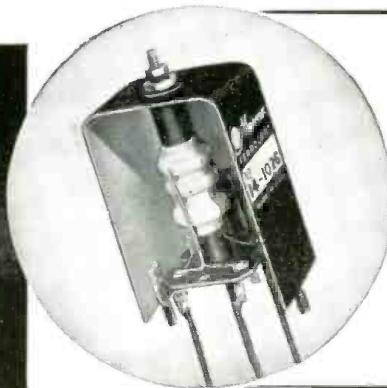

### Replace Broadcast Band Coils Easily

These Adjustable-Inductance Ferrocart (iron core) coils will replace Antenna, RF or Oscillator coils without the trouble of locating "exact duplicates" because they are continuously variable in inductance over a wide range. The inductance of the old coil is easily matched by simple screwdriver adjustment. Ferrocart iron cores add gain and selectivity to the receiver. Available shielded or unshielded, shipped with complete instructions. Order by number. 14-1026 Univ. Ant. Coil; 14-1027 Univ. R.F. Coil; 14-1028 Univ. Osc. Coil. Price \$1.50 each.



# MEISSNER

MANUFACTURING COMPANY - MT. CARMEL, ILL.

**ADVANCED ELECTRONIC RESEARCH AND MANUFACTURE**

Export Division: 25 Warren St., New York; Cable: Simontrice





# I Will Show You How to Learn RADIO by Practicing in Spare Time

I Send You 6 Big Kits of Radio Parts

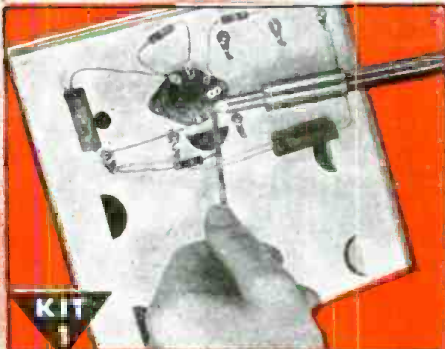

**KIT 1**  
I send you Soldering Equipment and Radio parts; show you how to do Radio soldering; how to mount and connect Radio parts; give you practical experience.



**KIT 2**  
Early in my course I show you how to build this N.R.I. Tester with parts I send. It soon helps you fix neighborhood Radios and earn EXTRA money in spare time.

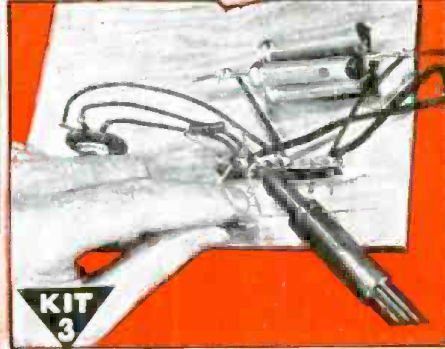

**KIT 3**  
You get parts to build Radio Circuits; then test them; see how they work; learn how to design special circuits; how to locate and repair circuit defects.

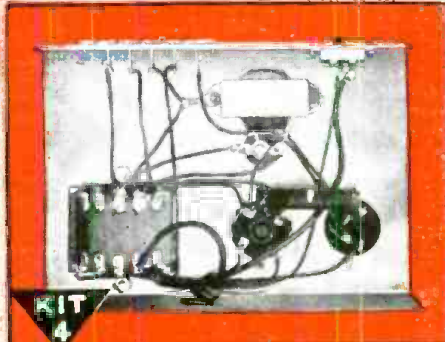

**KIT 4**  
You get parts to build this Vacuum Tube Power Pack; make changes which give you experience with packs of many kinds; learn to correct power pack troubles.

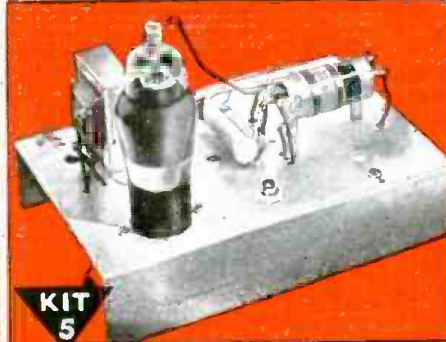

**KIT 5**  
Building this A. M. Signal Generator gives you more valuable experience. It provides amplitude-modulated signals for many tests and experiments.

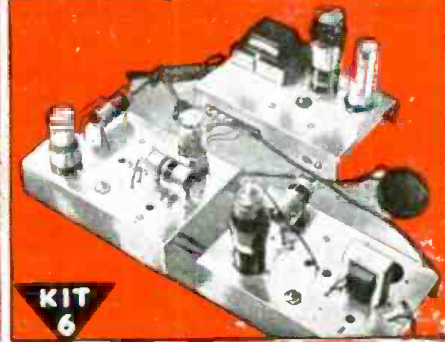

**KIT 6**  
You build this Superheterodyne Receiver which brings in local and distant stations—and gives you more experience to help you win success in Radio.

## I Will Train You at Home - SAMPLE LESSON FREE

Let me send you facts about rich opportunities in Radio. See how knowing Radio can give you security, a prosperous future. Send the coupon for FREE Sample Lesson, "Getting Acquainted with Receiver Servicing," and my FREE 64-page book, "Win Rich Rewards in Radio." See how N.R.I. trains you at home. Read how you practice building, testing, repairing Radios with SIX BIG KITS of Radio parts I send you.

built up in all branches of Radio! Think of even greater opportunities when Television and Electronics are available to the public! Send for free book now.

**Many Beginners Soon Make \$5, \$10 a Week EXTRA in Spare Time**

The day you enroll I start sending EXTRA MONEY JOB SHEETS to help you make EXTRA money fixing Radios in spare time while learning. You LEARN Radio principles from my easy-to-grasp Lessons—PRACTICE what you learn by building real Radio Circuits with Radio parts I

send—USE your knowledge to make EXTRA money in spare time.

**Find Out What N.R.I. Can Do for You**  
MAIL COUPON for Sample Lesson and my FREE 64-page book. It's packed with facts about opportunities for you. Read the details about my Course. Read letters from men I trained, telling what they are doing, earning. Just MAIL COUPON in an envelope or paste it on a penny postal. J. E. Smith, President, Dept. 5MX, National Radio Institute, Pioneer Home Study Radio School, Washington 9, D. C.

**OUR 31st YEAR OF TRAINING MEN FOR SUCCESS IN RADIO**

### Future for Trained Men is Bright in Radio, Television, Electronics

The Radio Repair business is booming NOW. There is good money fixing Radios in your spare time or own full time business. Trained Radio Technicians also find wide-open opportunities in Police, Aviation, Marine Radio, in Broadcasting, Radio Manufacturing, Public Address work, etc. Think of the boom coming now that new Radios can be made! Think of the backlog of business

**Good for Both - FREE**

MR. J. E. SMITH, President, Dept. 5MX  
National Radio Institute, Washington 9, D. C.

Mail me FREE, without obligation, Sample Lesson and 64-page book, "Win Rich Rewards in Radio." (No salesman will call. Please write plainly.)

Age .....

Name .....

Address .....

City ..... State ..... 4FR  
(Please include Post Office Zone Number)

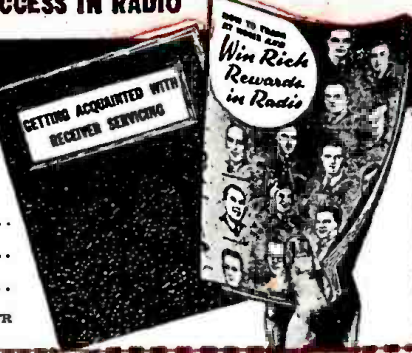

**My Radio Course Includes TELEVISION • ELECTRONICS FREQUENCY MODULATION**





**20,000  
VOLTS  
IN A  
2<sup>3</sup>/<sub>8</sub>" BULB!**

**ANOTHER "FIRST" BY NATIONAL UNION RESEARCH LABORATORIES**

**A**N example of how war-time research by National Union engineers is helping to lay the foundation for vastly improved post-war Television, FM and radio reception, is this new half wave high vacuum rectifier—the NU 1Z2.

Here is a miniature with the voltage handling capabilities heretofore possible only in full size tubes. For a high voltage rectified supply in the operation of radar and television equipment, the NU 1Z2 saves space—operates with increased efficiency—is exceptionally rugged. Its low filament power consumption suggests many new fields in circuit design and application, especially to the "ham" and experimenter.

For the distributor and service dealer, such original N. U. electron tube developments are creating new opportunities for profitable N. U. Tube replacement sales—today and in the future.

*National Union 1Z2  
High Voltage Rectifier*

Inverse peak anode voltage- max.....	20,000 volts
Peak anode Current.....	10 ma.
DC Output Current.....	2 ma.
Filament Voltage.....	1.5 volts
Filament Current.....	300 ma.

The NU 1Z2 is designed to withstand shocks in excess of 500 G's.

Maximum overall length.....	2.70"
Maximum seated height.....	2.37"
Maximum diameter.....	.75"
Bulb.....	T5½
Base Miniature Button.....	7 pin
Mounting position.....	Any

**NATIONAL UNION  
RADIO AND ELECTRON TUBES**

NATIONAL UNION RADIO CORPORATION • NEWARK 2, N. J.



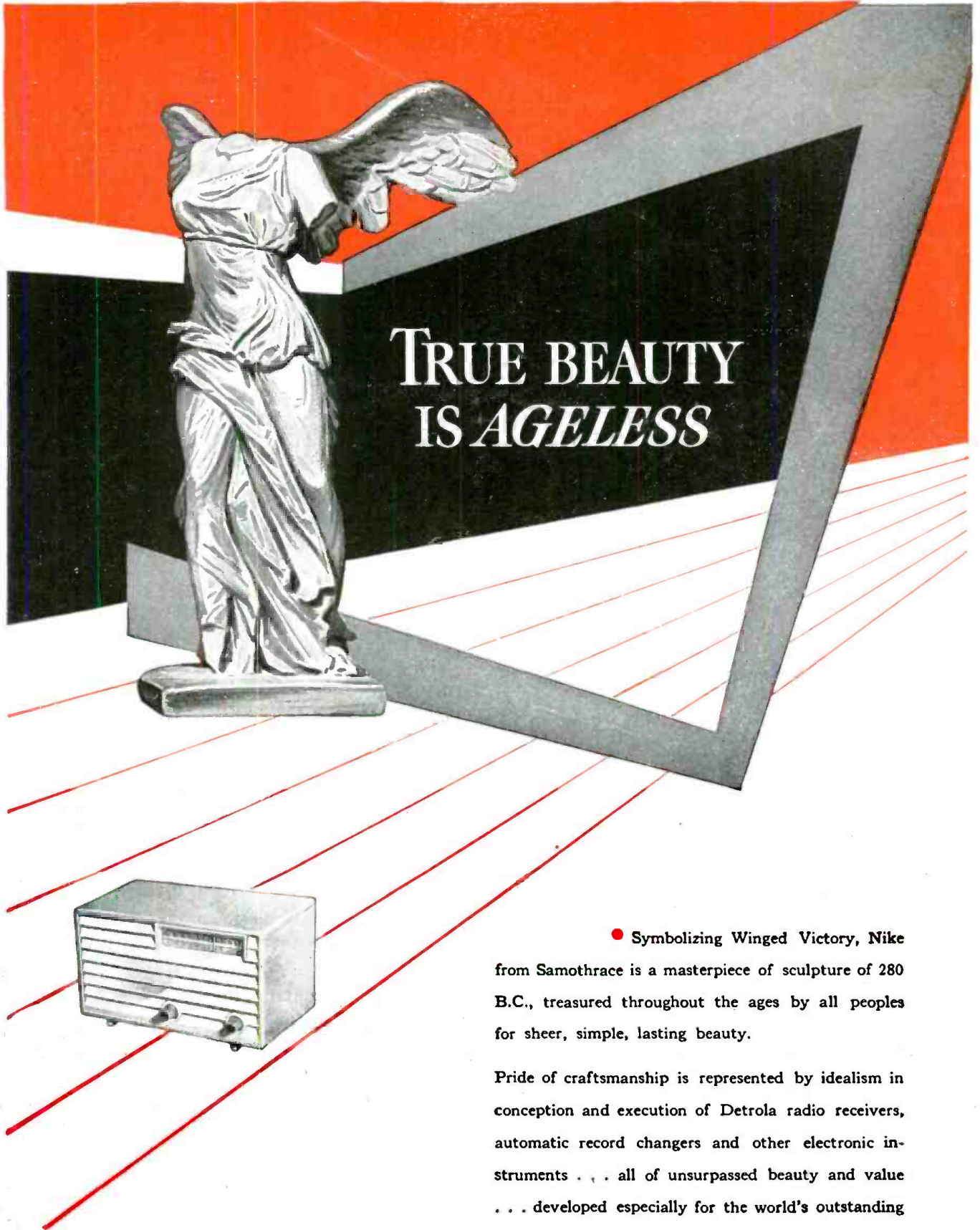

# TRUE BEAUTY IS *AGELESS*

● Symbolizing Winged Victory, Nike from Samothrace is a masterpiece of sculpture of 280 B.C., treasured throughout the ages by all peoples for sheer, simple, lasting beauty.

Pride of craftsmanship is represented by idealism in conception and execution of Detrola radio receivers, automatic record changers and other electronic instruments . . . all of unsurpassed beauty and value . . . developed especially for the world's outstanding merchants and their customers.

DETROLA RADIO DIVISION  OF INTERNATIONAL DETROLA CORPORATION, DETROIT 9, MICHIGAN





# NEW!

...the **MOST**  
**COMPLETE**  
**REPLACEMENT**  
**VIBRATOR**  
**GUIDE**  
ever published



*Ready for you NOW...*

Long hailed as one of the most helpful publications in the radio service field, the Mallory Replacement Vibrator Guide has run through 17 editions since 1934. Now comes the largest, most comprehensive edition of all — easier to read, easier to use, more valuable than ever before!

If you're an old timer in radio service, you'll recognize that a great deal of new material has been added. There's a whole new section on buffer capacitor circuits. Another section shows you how to service old radio sets that need obsolete or discontinued types of vibrators. Still another contains a complete cross-index of all vibrators.

Mallory is the first manufacturer in this post-war period to offer this up-to-date Guide. It's yours, as usual, without cost. Get a free copy of the Mallory Replacement Vibrator Guide at your nearest Mallory distributor.

**P. R. MALLORY & CO., Inc., INDIANAPOLIS 6, INDIANA**



*More than ever—  
ALWAYS  
INSIST ON*

**P. R. MALLORY & CO. Inc.**  
**MALLORY**  
APPROVED  
PRECISION PRODUCTS

**VIBRATORS • VIBRAPACKS\* • CONDENSERS  
VOLUME CONTROLS • SWITCHES • RESISTORS  
FILTERS • RECTIFIERS • POWER SUPPLIES**

ALSO MALLORY "TROPICAL" DRY BATTERIES, ORIGINALLY DEVELOPED BY MALLORY FOR THE U. S. ARMY SIGNAL CORPS, NOT PRESENTLY AVAILABLE FOR CIVILIAN USE.

\*Reg. U. S. Pat. Off.



# I'LL SHOW YOU HOW TO SUCCEED IN RADIO

Here's the right training for Big Post-War Pay!



F. L. Sprayberry, one of the country's foremost Radio Teachers.



A RADIO SERVICE BUSINESS OF YOUR OWN



A GOOD JOB IN RADIO & TELEVISION BROADCASTING

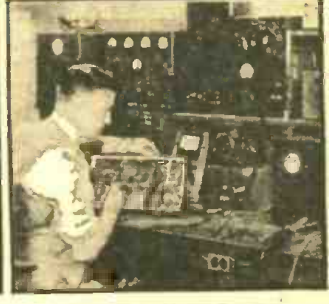

RADIO-ELECTRONIC SERVICE ENGINEER

## BE A RADIO ELECTRONICIAN



I SUPPLY A FULL RADIO SET for practical easy LEARNING

### NOW! YOU CAN PREPARE AT HOME IN YOUR SPARE TIME FOR THE AMAZING OPPORTUNITIES AHEAD IN RADIO — ELECTRONICS — TELEVISION

The offer I make you here is the opportunity of a lifetime. It's your big chance to get ready for a wonderful future in the swiftly expanding field of Radio-Electronics INCLUDING Radio, Television, Frequency Modulation and Industrial Electronics. Be wise! NOW'S the time to start. Opportunities ahead are tremendous! No previous experience is necessary. The Sprayberry Course starts right at the beginning of Radio. You can't get lost. It gets the various subjects across in such a clear, simple way that you understand and remember. And, you can master my entire course

in your spare time. It will not interfere in any way with your present duties. Along with your training, you will receive my famous BUSINESS BUILDERS which will show you how to make some nice profits while learning.

#### Prepares You for a Business of Your Own or Good Radio Job

My training will give you the broad, fundamental principles so necessary as a background, no matter which branch of Radio you wish to specialize in. I make it easy for you to learn Radio Set Repair and Installation Work. I teach you how to install and repair Electronic Equipment. In fact, you'll be a fully qualified RADIO-ELECTRONICIAN, equipped with the skill and knowledge to perform efficiently and to make a wonderful success of yourself.

### Just Out! FREE!

"How to Read Radio Diagrams & Symbols" . . . a valuable new book which explains in simple English how to read and understand any Radio Set Diagram. Provides the quick key to analyzing any Radio circuit. Includes translations of all Radio symbols. Send for this FREE book now, and along with it I will send you another big FREE book describing my Radio-Electronic training.



### GET FREE BOOKS

### SPRAYBERRY TRAINING GIVES YOU BOTH TECHNICAL KNOWLEDGE • SKILLED HANDS

There's only one right way to learn Radio Electronics. You must get it through simplified lesson study combined with actual "shop" practice under the personal guidance of a qualified Radio Teacher. It's exactly this way that Sprayberry trains you . . . supplying real Radio parts for learn-by-doing experience right at home. Thus, you learn faster, your understanding is clear-cut, you acquire the practical "know how" essential to a good-paying Radio job or a Radio business of your own.

#### I'll Show You a New, Fast Way to Test Radio Sets Without Mfg. Equipment

The very same Radio Parts I supply with your Course for gaining pre-experience in Radio Repair work may be adapted through an exclusive Sprayberry wiring procedure to serve for complete, fast, accurate Radio Receiver troubleshooting. Thus, under Sprayberry meth-

ods, you do not have one cent of outlay for manufactured Test Equipment which is not only expensive but scarce.

#### Read What Graduate Says "One Job Nets About \$26.00"

"Since last week I fixed 7 radios, all good-paying jobs and right now I am working on an amplifier system. This job alone will net me about \$26.00. As long as my work keeps coming in this way, I have only one word to say and that is, "Thanks to my Sprayberry training" and I am not afraid to boast about it."—ADRIEN BENJAMIN, North Grosvendale, Conn.

#### DON'T PUT IT OFF!

Get the facts about my training—now! Take the first important step toward the money-making future of your dreams. All features are fully explained in my big, illustrated FREE Catalog which comes to you along with another valuable FREE book you'll be glad to own. Mail Coupon AT ONCE!

#### SPRAYBERRY ACADEMY OF RADIO

F. L. Sprayberry, Pres.  
Room 20115  
Pueblo, Colorado

Please rush my FREE copies of "HOW TO MAKE MONEY IN RADIO, ELECTRONICS AND TELEVISION," and "HOW TO READ RADIO DIAGRAMS AND SYMBOLS."

Name ..... Age .....

Address .....

City ..... State .....

Tear off this coupon, mail in envelope or paste on penny postcard.



# RADIO CRAFT

AND POPULAR ELECTRONICS

Incorporating  
SHORT WAVE CRAFT TELEVISION NEWS  
RADIO & TELEVISION



**HUGO GERNSBACK**, Editor-in-Chief  
**FRED SHUNAMAN**, Associate Editor  
**I. QUEEN**, Editorial Associate  
**ELMER FULLER**, Shortwave Editor  
**E. A. WITTEN**, Technical Editor  
**A. PASCALE**, Production Manager  
**G. ALIQUO**, Circulation Manager  
**JOHN J. LAMSON**, Advertising Director  
**ALFRED STERN**, Promotion Manager

## IN THE NEXT ISSUE

A Four-Tube Bicycle Radio  
Modern Wire Recorder Design  
The Veteran Sets up a Shop  
Methods of Noise Elimination

Published by Radcraft Publications, Inc.  
Publication Office: 29 Worthington Street,  
Springfield 3, Mass.  
Editorial and Advertising Offices: 25 West  
Broadway, Tel. RE2-9690, New York 7, N. Y.  
Chicago Advertising Office: Radio-Craft, 308  
W. Washington Street, Suite 1413, Chicago 6,  
Ill. Tel. Randolph 7863.  
Cleveland Advertising Office: 405 Erie Bldg.,  
Cleveland, Ohio. Burdette Phillips, Manager.  
Tel. Main 9645.  
Los Angeles Advertising Office: 606 South  
Hill Street, Los Angeles 14, Calif. Ralph W.  
Harker, Manager.  
San Francisco Advertising Office: 532 Market  
St., San Francisco 4, Calif. Ralph W. Harker,  
Manager. Tel. Garfield 2481.  
New England Office: Bridgewater, Conn.,  
W. D. Ward, Manager.  
Michigan Advertising Office: 70 Highland  
Ave., Highland Park 3, Michigan. Harry R.  
Lipson, Manager.  
RADIO-CRAFT is published monthly on the  
25th of the month preceding that of date.  
Subscription rates: United States and pos-  
sessions, Mexico, Central and South American  
countries, \$2.50 a year, \$4.00 for two years,  
\$6.00 for three years. Canada, \$3.00 a  
year, \$5.00 for two years, \$7.50 for three  
years. All other foreign countries, \$3.25 a year,  
\$5.50 for two years, \$8.25 for three years.  
Special rates for members of the Armed Forces  
in U. S., or those addressed by A.P.O. or F.P.O.  
mail, \$2.00. Entered at the post office at  
Springfield as second-class matter under the  
Act of March 3, 1879. All communications  
about subscriptions should be addressed to:  
Circulation Manager, Radio-Craft, 29 Worth-  
ington St., Springfield 3, Mass.

Notice of CHANGE of ADDRESS should  
reach us at least one month in advance. When  
ordering a change, please furnish an address  
stencil impression from a recent wrapper if  
you can. Address changes cannot be made  
without the old address as well as the new.

### Foreign Agents

London—Atlas Publishing and Distributing  
Co., Ltd., 18, Bride Lane, Fleet St., London,  
E.C. 4.  
Melbourne—McGill's Agency, 179 Elizabeth  
St., Australia.

Text and illustrations of this magazine are  
copyright and must not be reproduced without  
permission of the copyright owners.  
Copyright, 1945, Radcraft Publications, Inc.

## Contents November, 1945 Volume XVII, No. 2

Editorial: GI Radio Servicemen.....	by Hugo Gernsback	85
Radio-Electronics Monthly Review.....		86

### ELECTRONICS

"Frozen" Electricity—The Electret.....	by Thomas A. Dickenson	88
Betatron—Atom Smasher.....	by O. Joe Olson	91
Radar—Weapon for Peace.....	by S. R. Winters	92
Flux Valve Aero Compass.....	by Raymond Lewis	93
Radar Indicators.....	by Major Eugene E. Skinner	95
This Radio Runs on Gas.....	by Carl R. Lawrence	122

### SERVICING

Licensing Problems and the Serviceman.....	by H. W. Schendel	90
Boat Radio Installations.....	by Henry B. O. Davis	94
Tube Replacements, Part V.....	by I. Queen	100
Capacitor-Resistors.....	by Ernst Gulkenheimer	103

### CONSTRUCTION

Explorer All-Wave Radio.....	by Bob White	96
Small Electronic Organ.....	by Marion Black	119

### SOUND

Results of Phono Needle Tests.....		99
A True Tone Control.....	by George Bertsche	97
An FM Phono Pickup.....	by Nathaniel Rhita	106

### TEST INSTRUMENTS

Dynamic Handful Signal Tracer.....	by Ralph Bloom	98
Vibrator Tester.....	by Harry L. Burcham	115
Electronic Voltmeter and Signal Generator.....	by M. E. Blaisdell	121

### DEPARTMENTS

New Radio-Electronic Devices.....		102
World-Wide Station List.....	by Elmer R. Fuller	104
Radio-Electronic Circuits.....		108
Try This One!.....		114
New Radio Patents.....	by I. Queen	116
Book Review.....		117
The Question Box.....		118
Technotes.....		139
Communications.....		140



### ON THE COVER

The cover this month shows an application of radar as an indirect locator of aircraft. Controlling a powerful searchlight, it brings it onto the target which can then be illuminated at will. Information may thus be gained which is occasionally more valuable than the simple destruction of the aircraft.



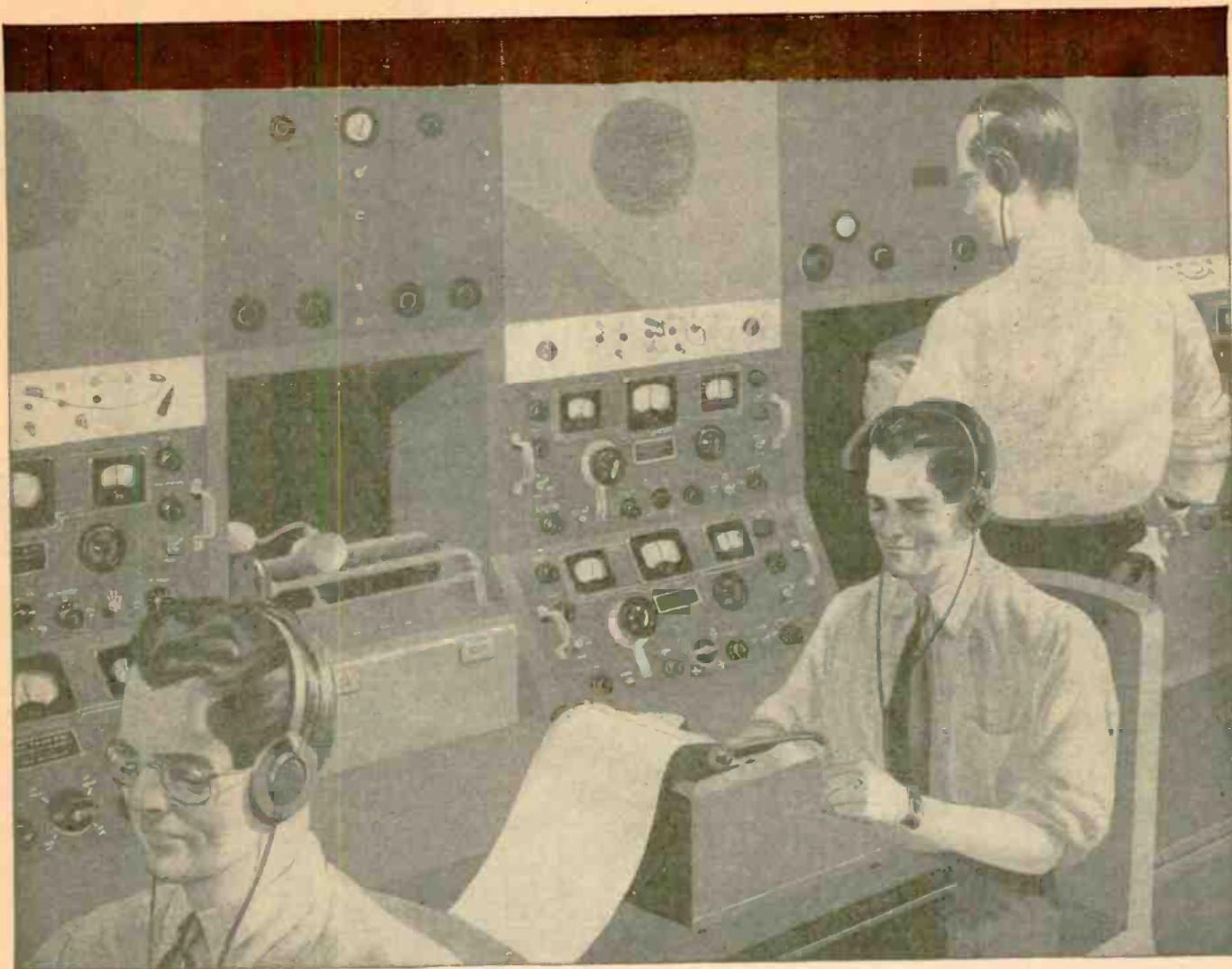

## ***RID at work*** } HOW RADIO INTELLIGENCE DIVISION KEEPS WATCH...

● The radio amateur has distinguished himself outstandingly in the service of his country in time of war. One of his most important jobs is in the RID—Radio Intelligence Division of the Federal Communications Commission. Above you see sketches of typical hams at work in the intercept room of one of the RID's monitoring stations. With high powered, extraordinarily sensitive equipment like this, manned by experts, the RID patrols the ether, spots illegal transmitters, locates lost planes and keeps watch on the entire radio spectrum to guard home front

security. Vigilance like this has put more than 400 clandestine stations out of commission. About 70% of the personnel employed by RID consists of licensed amateur radio operators. For these exacting technicians Hallicrafters has developed the finest equipment that can be made. When the time comes Hallicrafters will be ready with a full line of HF, VHF and UHF communications equipment—designed specifically for the amateur and for all others who need the latest and best combined "in the radio man's radio."

COPYRIGHT 1945 THE HALLICRAFTERS CO.

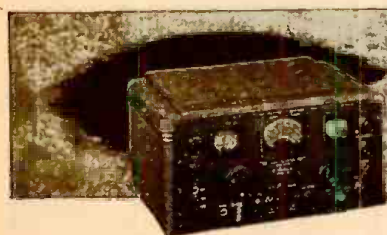

This is a model SX-28A, a communications receiver operating on a frequency range of 550 kc to 42 Mc, continuous in 6 bands including regular broadcast band.



BUY A WAR BOND TODAY

# hallicrafters RADIO

THE HALLICRAFTERS CO., WORLD'S LARGEST EXCLUSIVE MANUFACTURERS OF SHORT WAVE RADIO COMMUNICATIONS EQUIPMENT, CHICAGO 16, U. S. A.  
RADIO-CRAFT for NOVEMBER, 1945



# SPRAGUE TRADING POST

A FREE Buy-Exchange-Sell Service for Radio Men



## READ WHAT THESE SERVICEMEN SAY!

"I received replies from all over the country from my Trading Post ad . . . I'm sure that many others, like myself, will use your products solely . . . Certainly this is the least we can do in repayment for the swell service rendered us." H.T., New York City.

"I'll never forget the favor you did for me through the Sprague Trading Post!" A.L., Salem, Ill.

"Thanks a million! I only hope I can again sell and install your excellent products after this emergency!" Cpl. S.S., Louisiana.

"The results were terrific! I'll not forget Sprague's 100% service." B.R.S., Ohio.

"Thanks for running my ad. It was very successful. This service of yours should and will keep Sprague in the minds of all radio men after the war!" C.J.S., New York.

"I used Sprague Condensers before the war, and intend using them as long as I can get them during the war and after it!" E.A.F., Georgia.

"Thank you again—and be assured I'll not forget this favor when making my purchases!" L.G., Miss.

"Thank you for running my ad. When I return to business from the war, you can count on me to use Sprague's as usual!" H.H.P., Wisconsin.

**FOR SALE OR TRADE**—Crosley 8" speaker with metal cabinet and 2-01A, 1-71A, and 2-22A tubes. Thomas Peyton, Jr., Rt. No. 2, Box 128, Utica, Miss.

**URGENTLY NEEDED**—EC-1 or similar short-wave communications receiver. Joseph Smith, 16172428, 50th S.W.A., Det., Camp Pineblade, Calif.

**FOR SALE**—Brush type RC-20 crystal cutting head, \$12; Astatic type S-12 pickup with General Industries dynamically balanced dual speed turntable, \$25. Want Meisner 12-tube all-wave receiver. Frank Dano, 3852 Eagle St., San Diego 3, Calif.

**WANTED**—Echophone EC-1 new or used. Reed B. Gillette, R.F.D. No. 1, Sharon, Conn.

**WILL TRADE**—Castle 16mm motion picture films and darkroom eqpt. Want complete phono amplifier kit or 4-tube radio kit. Herbert Gahn, P.O. Box 682, Woodmere, Long Island, N. Y.

**FOR SALE**—Wall receptacles, switches, covers, outlet box sockets, iron cords, plugs, lightning arresters, tubes, etc. Edward Howell, Dillon, S. C.

**URGENTLY NEEDED**—Issue No. 3 of Radio manual. Allan Meyer, R. No. 2, Box 203, Anaheim, Calif.

**SELL OR TRADE**—Tubes, portable batteries and hard-to-get parts. P. Dymock, 1384 Greene Ave., Brooklyn 27, N. Y.

**FOR SALE**—Two home made amplifiers, tube complements, 2-6V6, 1-6SC7, 1-80, 1-6SK7, 1-6L6, without speakers, \$25 each. Robert D. Freed, 1140 Fifth Ave., New York 28, N. Y.

**WANTED**—Late model dynamic tube tester and sig. gen. S. Spizel, 173 Henry St., New York 2, N. Y.

**FOR SALE OR TRADE**—02A, 1N25, 1R5, 1S5, 15A6, 6K6, 6D6, 6K7, 12A6, 12C8, 12T7, 12S7, 12SE7, 14A7, 42, 80, etc., tubes at OPA list. Want tube tester; tubes and parts. Wilkerson Radio, Box 296, Mayfield, Ky.

**WANTED**—New No. 75 tube, K. M. Spencer, Wellsboro, B.R. No. 2, Pa.

**FOR SALE**—Philco model PT-89 tourist receiver; 2-6V power packs and ten 6U6 tubes. Joseph Anderson, R.F.D. 1, Box 47, New Sweden, Me.

**TO TRADE**—Good condition Dobro self-amplifying Hawaiian guitar. Want short wave or radio test eqpt. Sheldon Cleaver, 1409 Fairview Ave., Berwick, Pa.

**FOR SALE**—Tubes with adapters, 40% off OPA ceiling. Write for list, Robert W. Gorseline, 6 Ocean Green, S.W., Washington 20, D. C.

**URGENTLY NEEDED**—New 117P7GT tube and information on wire recorders. P. J. Hagan, 7411 Fayette St., Philadelphia, Pa.

**FOR SALE**—Twelve tube, 5-stage p.a. amplifier with speaker, \$100; gasoline engine a-c generator, \$95; and Hickok oscillograph RFO-3 with instructions. Radio Service & Repair, 716 Union St., Coffeyville, Kans.

**SELL OR TRADE**—Clough-Breglio OC sig. gen. 8 bands on fundamentals. Want photo eqpt. or camera. H. Gursine, 1481 Shakespeare, New York 52, N. Y.

**FOR SALE**—Thorndarson kit for pair of 6L6's, CHT series, comprising a T-17S12 output trans., list \$5.40, A T-75C51 choke, list \$6.00, A 17R50 power trans., list \$10.20. All perfect. Price, 60% off list and a pair of 6L6's included gratis. The kit is designed on a 25-watt basis. L. P. Work, 10441 Tireman, Dearborn, Mich.

**WILL TRADE**—RCA 5-tube aircraft beacon band radio receiver, Type 101, 185-405 battery operated. Want tube checker for octal base tubes or R.F. signal generator. Dixon L. Linton, Lantz, Md.

**WANTED**—Sky Champion S-20R also 50V6 and 35L6 tubes. Set must be A-1 condition. S/Sgt. B. R. Collier, Hq. Co. No. 2, I.R.T.C., Camp Gordon, Ga.

**FOR SALE**—RCP No. 432 trouble shooter; pocket type V-O-M, \$5 plus postage. Mitchell Radio Service, 2208 S. 10th St., Burlington, Iowa.

**WILL TRADE**—Radio parts, meters and tubes, want Rider's manuals, Robert Truhlar, 2714 Elder Lane, Franklin Park, Ill.

**FOR SALE OR TRADE**—Miller preselector \$10; new T-55, \$5.50; 812, \$3; used FT252A, \$7; 40-meter coils; 1000 watt, \$1.75; 50 watt, \$7.5. Bud Mc1882, Cardwell MR20BS variable condensers. Want 8-29, 250TH and 500-watt modulation xformer. Bill Bennis, 145 S. Maple, Webster Groves 19, Mo.

**WANTED**—Triplet 1220C free-point tester with adapters and instructions. Smith Radio Service, 132 S. 7th St., Steubenville, Ohio.

**SELL OR TRADE**—Multitester with 7 1/2" meter for volts, millamp, ohms, decibels, etc. Want course in radio or what have you? J. Bazewick, 300 N. Christiansa St., Chicago 18, Ill.

**FOR SALE**—3 RCA 150 watt transmitters, 30-50 watt transmitters with 5 Weston meters, 10-20 to 42 MC radio phone transmitters, 2-200 watt transmitters. A real buy. A government surplus. Parts of the highest type used. Want high power transmitting tubes. 849, 851, 806, 852, 860. Need especially 1-961, Nelson K. Stover, 1357 Hill St., York, Pa.

**WANTED**—Tubes, 70L7, 92L7, 12B8, 6AK6, 0A2, 9092 and 9008. A. M. Stump, 311 Marathon Ave., Dayton 6, Ohio.

**SELL OR TRADE**—Motorola record player and automatic changer for 10" or 12" records. Want V-O-M, Victor H. Tooker, 735 W. Main St., Wilmington, Ohio.

**FOR SALE**—Weston 776 oscillator, 669 VTVM; Dumont 158, 8" oscillograph and tube; Clough-Breglio ODA oscillator with new batteries; Hickok 47X capacitor meter and Carron CCH signal tracers. Lewis M. Clark, 105 Second St., Campbellsville, Ky.

**WANTED**—G.I. recorder and playback unit, two speed. Must be A-1 condition and include microphone. Other make considered. Joseph Albright, 415 S. Main St., Tipton, Ind.

**FOR SALE**—Transmitter with T-21 osc. 811 buffer; a pair of T-40's in p-p mod. by a pair of HY40's in CIB, built-in metal cabinet. E. J. Hoover, 209 N. Adams St., Mt. Pleasant, Iowa.

**FOR SALE OR TRADE**—One ea. 24, 24A, 80, 27, 47, 35, 35Z3, 6CSQGT, 6J7GT, 12SQGTG, 6K7GT, 12SQGT, 6U5, 5Y3GT, 6K7G, 6F6, 6F6G, 6SQGT, 6CSGT tubes; 1-6" magnetic speaker; 4" dial, etc. What have you? W. Odie Manning, 1412 Columbus Ave., Portsmouth, Va.

**FOR TRADE**—Meters mostly Weston 301 including microammeter and foundation type. Total value over \$100. Also many hard-to-get tubes. Trade only for Supreme 561 or for Hickok 188 or RFO-5. McKay Research Laboratory, Eustis, Fla.

**WANTED**—Communications receiver ECO-1, ECO-2, S19-R or S20-R. Pvt. John L. Hecmeister, 45016318, Co. B, 115 Bn, 78th Reg., Camp Robinson, Ark.

**FOR SALE**—Hickok AC49 mutual conductance tube tester; Supreme radio analyzer No. 333; first and second I.F. transformers and IS5, 6F5, 6H6, 6K3, 6SJ7, 6SK7, 6V6, 7A8, 7B6, 7C5, 7Q7, 12A8, 14B6, 25Z5 and 31 tubes \$75. D. L. Dokus, 115 34th St., N.E., Canton 3, Ohio.

**WANTED**—16mm sound projector. Will consider ampro or equal. Describe fully. Paul Lebeck, 44 16th Ave., S.W., Cedar Rapids, Iowa.

**FOR SALE**—RCA—TRK-5 combination radio and television receiver and large stock hard-to-get tubes at OPA list. Louis Deutsch, 606 E. Anchor St., Philadelphia, Pa.

**WANTED**—1D8GT tube. Harry Matzko, New Auburn, Wis.

**SELL OR TRADE**—15-tube television kit with all parts, schematic circuit and lay-out of parts diagram. Large assortment other eqpt. Write for list. Irvin Jay Gordon, A.R.T. 3/c Electronics Test, U.S. Naval Air Test Center, Patuxent River, Md.

**FOR SALE**—Telephone hand set with phone and microphone plugs \$11; also 35Z5, 1N5, 1H5 and 3Q5 tubes. I. R. Sideiko, 30 Main St., Luzerne, Pa.

**WANTED**—Receiver, transmitter, radio parts, machinist tools, books and supplies; also 1N5, 50L6, 1A7 tubes. Joseph Lawranawic, Box 6771, Cleveland 1, Ohio.

**URGENTLY NEEDED**—Three 80, 2 ea. 35Z5, 50L6, 25Z5, 43, 6C6, 6D6, 6H6, 6K7, 7A7, 12A7, 13B6, 25A7GT/G, 32L7GT, 35Z4GT, 70L7GT and 117Z6GT/G tubes. Will sell Astatic crystal microphone and "grip to talk" desk stand; 8" shielded cord and phone adapter, \$9. Nick E. Grimaldi, 1332 W. Chestnut St., Chicago 22, Ill.

**FOR SALE**—V.H.F. 3/4 meter transceiver \$18; Abbott M.R.T. 3 V.H.F. 112-116 mc. transceiver \$30, and 12-12SQ7GT/G, J-31, and 1-12SL7GT/G tubes. Want 70L7GT/G and Rider's manuals. William T. Rhoades, 2406 Rosemont Blvd., Dayton 10, Ohio.

**WANTED**—Used radio sets—table models or chassis and speakers only. For overseas educational work in radio repair. Charles E. McMasters, Information and Educational Division, % Postmaster, Miami, Fla.

**URGENTLY NEEDED**—AC-DC multitester. Robert Rutherford, W. Jefferson St., Franklin, Ky.

**FOR SALE**—Combination Triplet oscillograph No. 1151; V-O-M No. 1125; 69 radio tubes; 46 adapters \$135. Leroy Barber, 1014 Woodlawn, Ann Arbor, Mich.

**WANTED**—6F7 tube and 25Z5 tubes. What have you? P. J. Hagan, 7411 Fayette St., Philadelphia, Pa.

**SELL OR TRADE**—Twenty 6Z5 tubes with adapters to 25Z5 and 25Z6. Want sig. gen. or what have you. C. A. Winans, Morris, Ill.

**WANTED**—Schematic of Chevrolet auto radio #885, 424 showing values of condensers, resistors, etc. E. H. Barrow, P.O. Box 991, Belle Glade, Fla.

**FOR SALE**—RME DB 20 preselector perfect, \$35. L. B. Pearson, 407 Park Place, Brooklyn, N. Y.

### YOUR OWN AD RUN FREE!

During the past three years, over 9,000 buy-trade-sell advertisements have been run free of charge in The Sprague Trading Post—and as long as the need exists this unique service to members of the radio profession will be continued. Send your ad today. Confine it to scarce radio materials. WRITE CAREFULLY or print. Hold it to 40 words or less. Sprague, of course, reserves the right to re-write ads as necessary, or to reject those which do not fit in with the spirit of this service.

HARRY KALKER, Sales Manager

Dept. RC-115, SPRAGUE PRODUCTS CO., North Adams, Mass.  
Jobbing Distributing Organization for Products of the Sprague Electric Co.



# SPRAGUE CONDENSERS KOOLOHM RESISTORS

T.M. REGISTERED U.S. PATENT OFFICE

Obviously, Sprague cannot assume any responsibility, or guarantee goods, services, etc., which might be exchanged through the above advertisements.



# ENJOY GREATER OPPORTUNITIES... for GOOD PAY and a BRIGHT FUTURE

Get into **RADIO  
ELECTRONICS**

THROUGH DeFOREST'S A-B-C  
TRAINING & EMPLOYMENT SERVICE



## PREPARE AT HOME IN SPARE TIME or IN OUR CHICAGO LABORATORIES

Radio, Electronics, Radar—and all the many applications and opportunities of each, are wide open to *trained* men! If you are even slightly mechanically minded . . . if you can follow clear, easy-to-understand instructions—you can prepare *now* for this *Good Pay, Bright Future* Industry—in your SPARE TIME AT HOME, or right here in OUR MODERN CHICAGO LABORATORIES! When you complete our training you'll be fully qualified for a good-pay job in the Radio-Electronics Industry—or to start a business of your own. Mail coupon TO-DAY for FREE information!

### VETERANS!

DeForest's offers you Residential or Home Study G. I. Training.

### A MOVIES MAKE LEARNING FASTER—EASIER

An exclusive DeForest's home radio training advantage is "Learn-by-Seeing" MOVIES. You use a genuine DeVry Motion Picture Projector and Specially Prepared Training Films to help you master important Radio Fundamentals FASTER—EASIER . . . right in your own home!

### B ACTUAL "SHOP EXPERIENCE" FROM 133 PRACTICAL EXPERIMENTS

You "Learn-by-Doing" by making 133 fascinating experiments with 8 Big Kits of Radio Parts and Assemblies. You build modern Radio Receiving Circuits, Electric Eye Devices, an Aviation Band Circuit, Public Address System, Wireless Microphone, and scores of other interesting, practical Radio-Electronic Devices. DeForest's valuable "Block System" permits easy and quick rearrangement of parts and circuits, with no unnecessary, time-consuming mechanical work required.

### C "SYNCHRO-GRAPHIC" LESSON TEXTS SPEED PROGRESS

Another exclusive DeForest's advantage is the "Synchro-Graphic" feature of the 90 Lesson Texts, prepared under the personal supervision of Dr. Lee DeForest, the "Father of Radio." Makes progress speedier because all lesson diagrams and charts are printed on sheets that *fold out*—keeping illustrations constantly synchronized to text. Eliminates confusion from frequent flipping of pages to refer back or ahead to illustrations mentioned in text.

## YOU GET EFFECTIVE EMPLOYMENT SERVICE

When you complete DeForest's Training you get the help of De Forest's Effective Employment Service which has placed so many men in good-pay jobs with the industry's leading manufacturers . . . an *extra* service available to you regardless of where you live, regardless of when you want to use it—without added cost!

### SEND FOR FREE INFORMATION

Mail the coupon today for the big book "Victory for You!" and the Equipment Folder. See how you can make your start towards a *good-pay job* and a *bright future* in the vast billion-dollar Radio-Electronics Industry. Or if interested in DeForest's RESIDENTIAL TRAINING in the modern CHICAGO LABORATORIES shown at left, write for special details.



DEFOREST'S TRAINING INCLUDES INSTRUCTION IN MOTION PICTURE SOUND EQUIPMENT, FM RADIO AND TELEVISION . . .

E. B. DeVry, President  
DeFOREST'S TRAINING, INC.,  
2535-41 North Ashland Avenue, Dept. RC-B11  
Chicago 14, Illinois, U.S.A.

Please send me your "VICTORY FOR YOU!"  
BOOK and EQUIPMENT FOLDER

Name \_\_\_\_\_ Age \_\_\_\_\_

Address \_\_\_\_\_

City \_\_\_\_\_ Zone \_\_\_\_\_ State \_\_\_\_\_

If under 16, check here for special information.

If a veteran of World War II, check here.



**DeFOREST'S TRAINING, INC.**  
CHICAGO 14, ILLINOIS



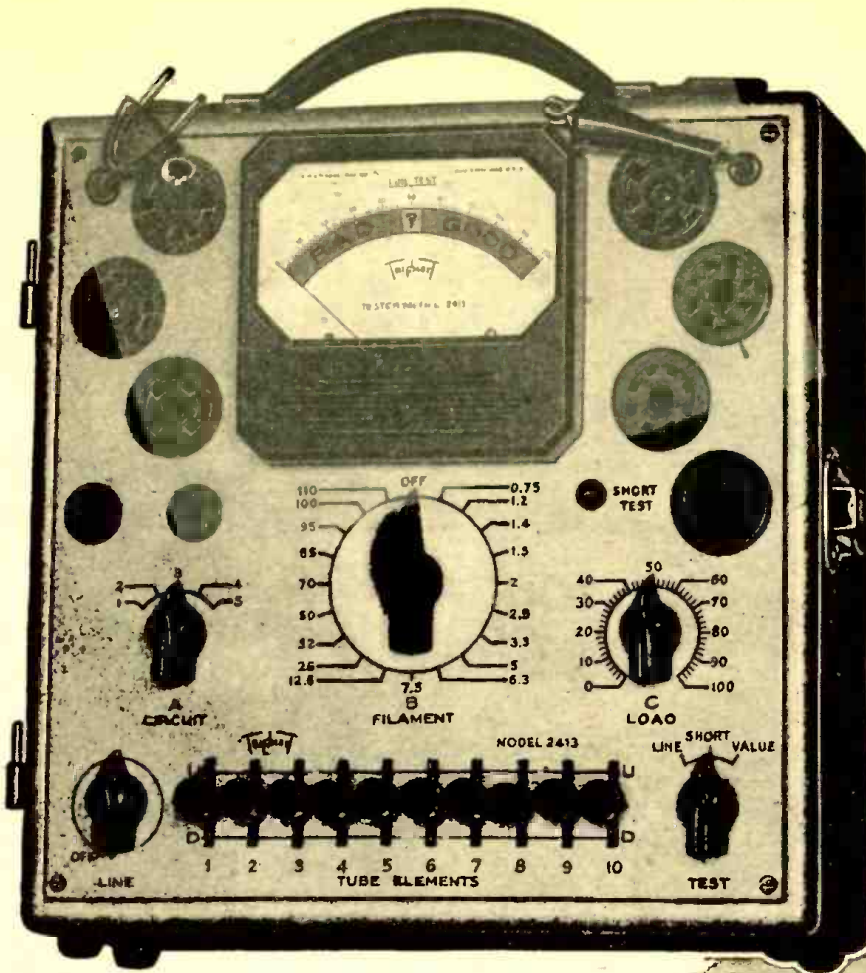

MODEL  
2413

is another  
member of the  
NEW TRIPLETT  
Square Line

## The New Speed-Chek Tube Tester

**MORE FLEXIBLE • FAR FASTER • MORE ACCURATE**

Three-position lever switching makes this sensational new model one of the most flexible and speediest of all tube testers. Its multi-purpose test circuit provides for standardized VALUE test; SHORT AND OPEN element test and TRANSCONDUCTANCE comparison test. Large 4" square RED • DOT life-time guaranteed meter.

Simplicity of operation provides for the fastest settings ever developed for practical tube testing. Gives individual control of each tube element.

New SQUARE LINE series metal case 10" x 10" x 5 1/2", striking two-tone hammered baked-on enamel finish. Detachable cover. Tube chart 8" x 9" with the simple settings marked in large easy to read type. Attractively priced. Write for details.

### Additional Features

- Authoritative tests for tube value; shorts, open elements, and transconductance (mutual conductance) comparison for matching tubes.
- Flexible lever-switching gives individual control for each tube element; provides for roaming elements, dual cathode structures, multi-purpose tubes, etc.
- Line voltage adjustment control.
- Filament Voltages, 0.75 to 110 volts, through 19 steps.
- Sockets: One only each kind required socket plus one spare.
- Distinctive appearance with 4" meter makes impressive counter tester — also suitable for portable use.



# Triplett



ELECTRICAL INSTRUMENT CO. BLUFFTON, OHIO

RADIO-CRAFT for NOVEMBER, 1945



**MAKE MORE MONEY**

**IN Radio TELEVISION & ELECTRONICS**

**Now!**

**GET THESE 2 BIG BOOKS**

**FREE!**

You men already in Radio know how great the demand is for trained, experienced servicemen, operators and technicians. You know how fast the field is growing and how important it is to keep up with developments — F.M. Receivers, Electronics and Television. You know, too, a fellow cannot learn too much about any industry for **REAL SUCCESS**. Whether you have experience or are merely **INTERESTED** in radio as an amateur, you must recognize the **WONDERFUL OPPORTUNITY** right within your grasp to cash in on your natural abilities. Make them pay dividends. Get into the **EXPERT RADIO SERVICE FIELD**. Be an F.M. and **TELEVISION specialist—OWN A BUSINESS OF YOUR OWN**, if you prefer. Fill out and mail the coupon below for all the details of our plan.

Get the Latest Inside Information—Short Cuts—Trade Secrets by

Here's Just a Few of the Interesting Facts you Learn with the **FREE MANUAL**.

1. Routine for diagnosing Radio Troubles.
2. Preliminary Inspection of Receivers.
3. How to Check Power Supply.
4. How to Identify Various Stages of Receiver.
5. How to Trace the Circuit and Prepare Skeleton Diagram.
6. How to Test and Measure Voltages.
7. How to Test Speaker in Audio Stages.
8. How to Test Detector, I.F., R.F., and Mixer Stages.
9. Complete Reference Table for Quickly Locating Receiver Troubles.

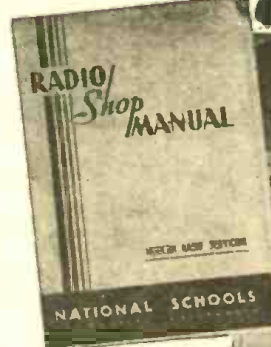

**SHOP METHOD HOME TRAINING**

**FROM A REAL ESTABLISHED RESIDENT SCHOOL**  
Now the famous National Schools brings its exclusive Shop-Method of training right into your own home. You can learn the most up-to-date, approved projects, systems and circuits step by step in your spare time. This is the sound practical training you want and need—the development of experienced instructors working with thousands of students right in shops, **NEW F.M. broadcast studios and experimental laboratories of NATIONAL SCHOOLS**—one of the most advanced trade educational centers in the world.



**LEARN BY DOING**

Work with Real Experimental Equipment Furnished without Extra Cost as Part of Your National Training

*Experience is the best teacher.* You learn by experience with the exclusive National Shop-Method of Home Training. In the course of your study you actually build various types of receivers—a powerful superheterodyne, a signal generator, an audio oscillator and others—you make tests and conduct experiments that *show you the why and how of things*. You understand what makes the various elements of electronics operate because you actually see them work for you. Not only do you gain marvelous experience by this method of learning but you receive valuable equipment you will use on the job in the practice of your profession as an electronics expert. *Mail the coupon* and learn what this means to you.

**National Trained Men Now Making the Best Money in History**

The real value of National training shows up on the quick progress our men make on the job. Incomes that seemed fantastic only a short time ago are now being reported by National graduates. And this is only a sample of what the future holds for the **MAN WHO KNOWS RADIO, ELECTRONICS, F.M., TELEVISION** and allied subjects. National is proud of the progress its graduates are making all over the world. Read the facts—the actual proof in the books we send you **FREE**.



Send the Coupon and prove to yourself what **YOU** can do in **RADIO!**

**Be Sure Of Your Success And Security After The War**

Don't let your post-war ambitions lag. Don't let **YOUR** future depend on others. Build a career for yourself. Never in all history has the returning serviceman, or war worker been confronted with such a great future if he reaches out and grasps it **NOW**. Here is a new world opening before you. Get ready now while you are still in uniform—while you are on your war job. Then you can soon step into an essential, well paid position or, with little capital, **GET INTO BUSINESS FOR YOURSELF**. It isn't a bit too soon to start now. Radio men are vitally needed. Fill out and mail the coupon immediately and examine the **NATIONAL SHOP METHOD HOME TRAINING COURSE** carefully, without obligation.

**FREE LESSON INCLUDED**

Examine the exclusive National Shop Method of Home Training. See for yourself how sound and practical it is. Be convinced that you can learn Radio, Electronics, Television—quickly and easily in your spare time. You can't tell until you try. This trial is **ABSOLUTELY FREE**. Fill out the coupon immediately while you are thinking about it and drop it in the mail at once.  
Mail the coupon here for the books that tell you the complete story of the marvelous new system of training in Radio, Electronics and Television. Learn the facts of this exclusive shop-method of home training. See for yourself! **DECIDE FOR YOURSELF!**  
This is the **MODERN SYSTEM OF TRAINING**: it matches the rapid progress constantly being made in Radio, Television and Electronics. It is **TIME TESTED**, too. National Schools has been training men for more than a third of a century. It is the very same training that has helped thousands to more pay and greater opportunity. You owe it to yourself—your future—to read the book "Your Future in Radio, Electronics and Television"—**FREE** to you when you send in the coupon.

**NATIONAL SCHOOLS**

LOS ANGELES 37, CALIFORNIA EST. 1905



**MAIL OPPORTUNITY COUPON FOR QUICK ACTION**

National Schools, Dept. 11RC  
4000 South Figueroa Street, Los Angeles 37, California.

(Mail in envelope or paste on penny post card)

Mail me **FREE** the two books mentioned in your ad, including a sample lesson of your course. I understand no salesman will call on me.

NAME ..... AGE .....

ADDRESS .....

CITY ..... STATE .....

Include your zone number



# SYLVANIA NEWS

## RADIO SERVICE EDITION

NOV. Published by SYLVANIA ELECTRIC PRODUCTS INC., Emporium, Pa. 1945

**SYLVANIA  
SERVICEMAN  
SERVICE**

by  
**FRANK FAX**



Established radio servicemen will experience an unprecedented volume of business during the months to come, while large numbers of returning, radio-trained veterans (from the Signal Corps and related activities) will be setting up their own shops.

Although many servicemen now have wider technical experience than ever before, they will find it increasingly important to have a good working knowledge of business methods — to make the best of a profitable situation and become firmly placed as part of the community's radio trade.

As one of its helps to oldtimers during this upswing of repair activity — as well as to newcomers with limited experience as shop owners — Sylvania has devised a simplified accounting system entitled "Business Record for Income Tax Purposes." This book is ideal for keeping a complete and accurate record of business transactions, payroll, profit-and-loss — and making out income tax returns quickly and easily. Available now at your Sylvania distributor, and priced nominally at \$1.00, you can start using this handy system immediately. Order yours today.

Free competition is the life  
of trade . . . and progress;

Only independent means of distribution  
preserves freedom of competition;

There will always be a place at the top  
for independents who work together to provide  
an even higher standard of American living.

SYLVANIA ELECTRIC PRODUCTS INC.

*Appearing in special advertisements, this plaque reaffirms Sylvania's basic policy of merchandising its products through independent wholesaler channels — as the most efficient and economical means of distribution.*

## RADIO SERVICEMEN URGED TO WORK CLOSELY WITH DISTRIBUTORS

### *Sylvania Distributors Offer You Helpful Business and Technical Aids*

Now that wartime restrictions on radio parts have been relaxed, the radio serviceman will depend more than ever on free-flowing channels of distribution for an efficient and economical parts supply.

That is the reason for Sylvania's sponsorship of an even closer co-operation between the independent distributors and radio servicemen and dealers. Through advertisements on the above "Declaration for Independents," Sylvania is urging even further teamwork than before.

And Sylvania is backing up these ads with real aid to the radio serviceman. Simple and exact bookkeeping methods, technical information, better business suggestions, point-of-sale material and many other helpful ideas are available through Sylvania Electric distributors.

One of these aids to more effective business methods is the "Business Record for Income Tax Purposes" — a unique Sylvania idea to solve the radio man's bookkeeping problems. Among the many other items is the "Sylvania Tube Complement Book" which lists complements of tubes for all makes of radios — plus much other valuable data, business stationery imprinted with the service shop's name, order forms, free advertising mats, circulars, posters, window stickers — to mention only a few.

The Sylvania Weatherproof Service Banner, 46" x 28", for display advertising on the outside of a shop, in window displays, on the side of a truck and other uses, priced three for a dollar, is another business aid with real customer-pulling power.

# SYLVANIA ELECTRIC

Emporium, Pa.

MAKERS OF RADIO TUBES; CATHODE RAY TUBES; ELECTRONIC DEVICES; FLUORESCENT LAMPS, FIXTURES, WIRING DEVICES; ELECTRIC LIGHT BULBS



# GI Radio Servicemen

... The radio servicing fraternity lives in a new world  
 ... At present this is a seller's world ... Servicemen  
 must now sell themselves to the new order to survive ...

HUGO GERNSBACK

**A** FEW weeks ago a radio serviceman who lives in the suburbs of a large city called upon us. Previous to his call he had written announcing that he would pay us a visit on a certain day. This is a routine occurrence and we see many radio servicemen and engineers during the course of a week, as can be readily surmised.

This particular caller, an old reader of the magazine, was recently discharged from the Army. He had set up shop again to re-establish himself once more in his community as a radio serviceman, as have countless other returned war veterans.

All this is prosaic and normally would not rate valuable space in any magazine. But this case was different because our caller, whom we may call Mr. X, had made the trip for one purpose only. That was to unburden himself of a "gripe." We use the GI term in this instance because Mr. X seemed on the surface to be justified in his wrath. Indeed, he was on the warpath. He cursed the radio industry from one end to the other in no uncertain terms. Said he, and we quote verbatim:

"Since my discharge and return home from abroad I have tried desperately to get back into the radio servicing game. I sent out no less than 35 letters to radio manufacturers, which includes set manufacturers as well as parts people, so I could get an agency for my town. So far I have received four answers out of 35 letters and these four answers were vague and hold out little promise. Yes, I did receive a few leaflets and circulars, and some advertising matter, but that is all. The few letters that came in referred me to the nearest distributor.

"Is that what we boys have fought a war for? Is that all the consideration war veterans are getting from the radio industry, when we are rarin' to go in order to do a job?

"Perhaps there is an answer, and if there is, I would

like to have it. That's why I called on you because I believe if anyone can tell me, you can."

After Mr. X had cooled down, and had lit the fresh cigarette which we offered him, we looked over the letter in which he had announced his coming.

The letter was written on a plain sheet of white paper, not too clean. It was handwritten by Mr. X, and the writing was none too intelligible.

We asked him if he would answer a few questions before we went to the core of the problem. He said he would be happy to answer all of them if he could.

We then asked him if he was married. He said not yet, but he intended to, "real soon." We continued:

"When you are going out with your best girl in your community just how do you proceed? Do you wear your working clothes? Do you take her to a nice eating place, unshaven, without collar and tie,

or just how do you proceed in that particular case?"

Mr. X looked puzzled and annoyed: "What has all this got to do with my problem? Nevertheless the answer is, of course I do spruce up. I put on my best blue suit and I certainly do tidy up, the same as we had to do in the Army. Any self-respecting man would do the same. My girl would not think much of me if I wanted to take her out in fatigue dress."

"Precisely. That is exactly what we thought," we answered.

"Now Mr. X, we find it necessary to give it to you straight, right between the eyes. We have before us your letter which you sent us. It is just a plain handwritten letter as you will observe. Few men realize the importance of a letter to a business concern. You would not think of taking out your best girl unless you were presentable, but you did send to big firms letters which land in the waste paper basket or are relegated to a clerk who has hundreds, if not thousands exactly alike and which under the

(Continued on page 130)



## Honorable discharge emblem awarded to veterans of this war.

### Radio Thirty-Five Years Ago In Gernsback Publications

**F**ROM the November 1910 issue of **MODERN ELECTRICS**:  
 Prevention of Interference by Selective Apparatus, by *G. F. Woris*.  
 Does Wireless Affect Homer Pigeons?  
 Why Do Wireless Waves Travel Farther by Night Than by Day, by *Professor W. Weiler, University of Esslingen*.  
 A Simple Current Gauge, by *Austin C. Lescarboura*.  
 Construction of an Exhausted Coherer, by *Kreigh B. Ayers, E.E.*  
 A New Wireless System, by the *Paris Correspondent*.  
 Improved Slider, by *James Karuza*.

HUGO GERNSBACK Founder	
Modern Electrics .....	1908
Electrical Experimenter .....	1913
Radio News .....	1919
Science & Invention .....	1920
Radio-Craft .....	1929
Short-Wave Craft .....	1930
Wireless Association of America .....	1908

Some of the larger libraries in the country still have copies of Modern Electrics on file for interested readers.

Radiophone System, by the *Paris Correspondent*.  
 New Liquid Microphone.  
 Design for an Oscillation Auto-Transformer, by *M. A. Deviny, B.S.*  
 Rotary Potentiometer, by *Edward Hutchinson*.  
 How to Make a Simple Fixed Condenser, by *Julius Kaufman*.  
 Wireless Insulators, by *Oren L. Grubbs*.  
 A Simple Hot Wire Ammeter, by *Percy W. York*.  
 Pocket Telegraph Sounder, by *G. A. Higbee*.  
 "Wireless Registry."



**R**ADAR waves are sent out from the transmitter at such power, and their energy so concentrated, that they can actually set afire steel wool held in their path. This was demonstrated last month by Dr. J. A. Hutcheson, associate director of Westinghouse Research Laboratories. Other demonstrations included sending out radar pulses from a parabolic antenna, reflecting them from a steel plate and lighting an ordinary fluorescent lamp (held in the hand of an assistant) with the reflected waves.

In the steel-wool burning experiment, the radar waves were piped down a wave-guide resembling a two-inch pipe. The steel wool was held a few inches from the opening from which the concentrated energy spouted.

The tremendous power with which the radar signals must be generated and transmitted is necessary because only a tiny fraction of the original power of the radar beam returns to the receiver, Dr. Hutcheson explained.

"On its outward journey, the radar beam travels through vast expanses of space," he said. "Much of it keeps right on going, never striking a target of any kind. Of the rays that do make contact with an enemy plane or ship, a large portion is scattered in all directions. Consequently, the beam 'fragment' that makes the homeward journey is so tiny that its electrical power would have to be increased many millions of times before it could light an ordinary electric bulb."

But at the radar base, he continued, highly sensitive receivers pick up the weak signal and amplify it many thousands of times, enabling the operator to make accurate readings.

Because the reflected signal is so weak, signals must be hundreds of billions of times as great as the power that returns to the receiver. The greater the range and the more square miles of space to be covered, the more powerful is the original output.

To demonstrate this, Dr. Hutcheson arranged a series of plates so that the surface of each was reflected into the one next in line. Then, switching on the transmitter, he directed a radar beam against



the first plate. The beam ricocheted from surface to surface until it reached the last plate in the series, where a sensitive meter was placed to measure the strength of the depleted beam.

"The original output of the transmitter was 1,000 watts. At the end of its journey, the beam had been reduced to less than one watt."

**R**ADIO TUBES "Shot from guns" made possible World War II's second most important secret weapon, it was revealed last month by Roger M. Wise, Vice-President in charge of Engineering, Sylvania Electric Products. The tiny tubes, smaller than average hearing aids, were part of a radio fuze which explodes the shell whenever it approaches within 70 feet of any solid object.

A "Radio Proximity Fuze" consists of a small radio transmitter and receiver, mounted in the plastic nose of a shell. The transmitter sends out a continuous signal, which when combined with signals reflected back from any object, actuate the receiver. The receiver consists of a detector and one or more pentode amplifiers, actuating a thyatron whose capacity is great enough to operate a relay which releases the detonator.

Three kinds of tubes were used, triode oscillator, pentode amplifiers and the thyatron. The latter, also in the "hearing-aid" size, is by far the smallest thyatron ever manufactured. The startling thing about these tubes is their ruggedness. When accelerated to 20,000 G, they have an "apparent weight" of more than 125 pounds. To help them withstand the terrific shock

of firing, the tubes are mounted in rubber cups which are then imbedded in wax.

The effect of these fuzes in increasing artillery fire effectiveness is beyond exaggeration. Combined with radar direction, the radio shells brought down 79% of the buzz-bombs at which they were aimed during the V-1 campaign against Southern England. In the Battle of the Bulge, the effectiveness of shells which sprayed Nazi troops with shrapnel from above instead of burying themselves in the mud and exploding more or less harmlessly, cracked the morale of the advancing Germans and was one of the chief factors in turning the advance.

**R**ADAR'S first peacetime triumph was reported last month from Boston. Receiving a radio call to the aid of a seaman stricken ill aboard the Liberty ship, Henry M. Libbey, Coast Guard men were unable to locate the ship due to fog. A Coast Guard pilot from the Salem air base then used radar to locate the vessel, landing beside it in thick fog and taking the stricken sailor aboard the plane.

**A** MINE detector will be used to search for the original White House cornerstone, which was lost when the building was renovated after being burned by the British in 1814, it was announced by Lorenzo N. Simmons, White House architect, last month.

The original cornerstone is said to contain a metal box filled with documents which now would have incalculable historical value.



Left—Dr. Hutcheson burns steel wool with radar waves, directed downward from the cylindrical wave guide. Right — Roger M. Wise, Sylvania's vice-president in charge of engineering, holds four of the radio proximity fuze tubes. The little thyatron is at the extreme right.

# Radio-Electronics

## Items Interesting



# Monthly Review

## to the Technician

**F**M OPERATION on the new high-frequency bands is to begin on a regular basis on January first, the Federal Communications Commission ruled last month. Equipment tests are to start by December 1, a month before regular program service begins.

Licensees are permitted to continue on their old frequencies (43-50 megacycles) simultaneously with the transmissions in the 92-108-megacycle band until receivers for the new band (92-108 megacycles) are available to the public and owners of existing receivers have had time to convert to the new band.

The commission recognizes that equipment may not now be available for operation with the radiated power specified, accordingly licensees will be permitted to operate with less power until such time as materials and equipment are obtainable.

**P**OCKET RADIOS no larger than an ordinary pack of playing cards were predicted last month by officials of two radio companies, Sylvania Electric Products and Emerson Radio Corporation. Super-miniature tubes used in the radio proximity fuze, it was stated, would make possible such small receivers.

While tubes of the same general size have been used in hearing aids, they have not been particularly useful at radio frequencies. The new tubes are used as oscillators and R.F. amplifiers at high frequencies.

Officials of the two companies which helped develop and manufacture the radio fuse were also of the opinion that the tubes would be used in the proposed Citizens' Radio Band apparatus, presumably in handie-talkies.

**I**NCREASES of from 5 to 11 percent in the price of radio receiving tubes sold for installation as original equipment was announced last month by Price Administrator Chester Bowles.

"The reconversion pricing factors will permit radio tube and parts manufacturers to determine quickly their new ceiling prices for post-war production, and, at the same time, permit manufacturers of completed domestic radio sets to calculate quickly what their costs will be for sets returning to market," Bowles said.

Tubes and parts for replacement in the repair of sets are not affected by the action and continue to be the highest price sellers charged during March 1942.

The increase factors for original equipment tubes and parts are as follows:

Radio receiving set tubes, 10.4 per cent; coils for radio equipment, 11 per cent; radio transformers and chokes, 11 per cent; variable capacitors, nine per cent; speakers and speaker parts, nine per cent; fixed capacitors seven per cent; parts for electric phonographs and radio phonograph combinations, seven per cent; resistors all types five per cent; all other radio parts, as covered by maximum price regulation 136—machines, parts and machinery services and not explicitly covered above, five per cent.

**I**NSTALLATION of an experimental radar station to increase the safety of commercial air travel has already been made, at Stevenson Field, Winnipeg, Canada, according to information released by Trans-Canada Air Lines last month.

The installation, which was made possible by the loan of appliances by the RCAF, is not of a permanent nature and is being designed for experimental use by the company's communications department. The National Research Council, Ottawa, is co-operating in tests which are being made.

At Stevenson Field airport, radar, "the magic eye," will be able to detect the presence of all approaching aircraft whose actual positions as far away as 80 miles will appear on a screen in front of the man in charge of the equipment, even in bad weather and at night. He will then be able to order some to wait if traffic is too heavy and others he will be able to guide in, even though the pilots themselves might not know their own exact positions.

Use of radar to bring planes in for blind landings at night or in zero visibility has already been developed to a high degree in military flying. Now comes the first concrete evidence of the nearness of its use in peacetime operations.

This particular type is known as the "Plan Position Indicator," or P.P.I., which is radar in its most advanced form. Recorded on the screen as a dot is an aircraft in flight. The electronic beam, timed with the scanning antenna, moves around the face of the dial like the hand of a clock and gives a fluorescent picture of what the radar sees.

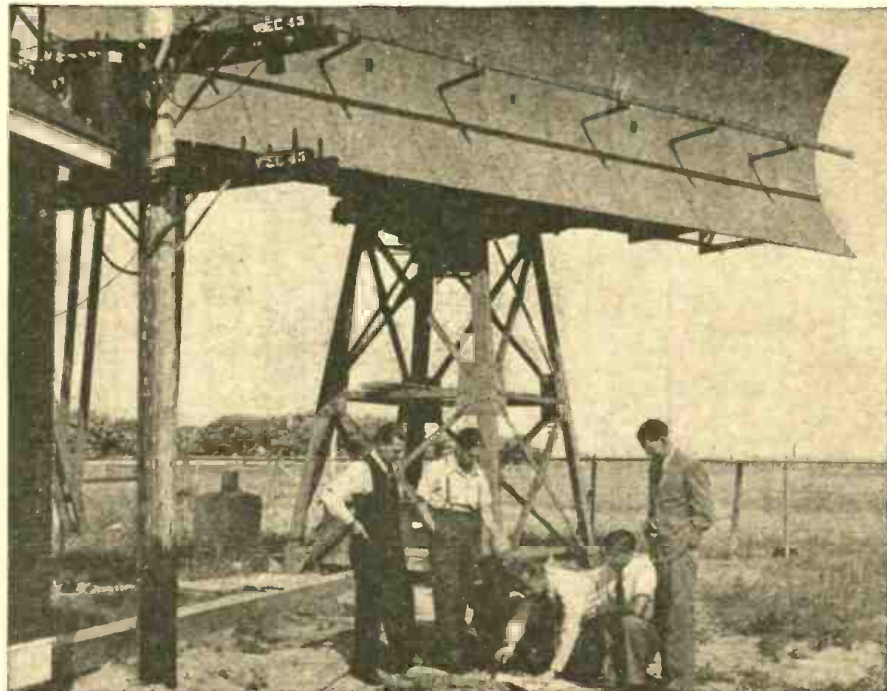

Antenna of the radar aircraft landing equipment at Stevenson Field, Winnipeg, Canada.

**S**URPLUS radio and electronic equipment valued between three and five billion dollars will be disposed of by 225 radio manufacturers distributed in strategic points throughout the country, the Reconstruction Finance Corporation announced last month.

According to RFC, the radio and electronics manufacturers will make repairs, tests and modifications before offering the equipment for commercial use.

Included will be several thousand "walkie-talkie" sets, which RFC said could be adapted for use by police and fire departments, railroads, in golf tournaments and for protection of property.

Other devices include mobile radio communication units, field telephone sets, radar devices, mine detectors, code practice sets and radio direction finder units. Very few of the items will be sold in their original form, the RFC stated.

**W**INTER meeting of the Institute of Radio Engineers, to be held in New York City, January 23 to 26, 1946, will be one of the most significant ever held by the Institute, states Edward J. Content, Chairman of the Meeting Committee.

With the end of the war, restrictions on information of a technical nature have been relaxed so that papers on radar and many other devices formerly of a confidential nature will be read. In addition to the many features that have always characterized the Institute of Radio Engineers' meetings, Mr. Content announced that an unprecedented number of electronics and radio companies—approximately 150—will have commercial exhibits.

**E**NCOURAGING railroad radio, the Federal Communications Commission announced last month that operator license requirements would be waived for the 500,000 railroad employees expected to use radio in railroad operations.

The commission approved a procedure requiring the applicants to pass an examination conducted by railroad examiners.



# "FROZEN" ELECTRICITY

## THE ELECTRET

By THOMAS A. DICKENSON



According to a not-too-thoroughly confirmed report from the recent Pacific theater of war, Signal Corps technicians were badly puzzled by a number of captured Japanese microphones. They looked

something like condenser mikes, with a thin diaphragm stretched in front of a back plate. The back plate was not metal as in a condenser microphone, but was a mere hunk of what looked like some kind of wax. There was no provision for polarizing voltage, and strange to say, the microphones worked without any.

What the bewildered technicians were up against was the electret, a little-known object which is a next-door neighbor to the magnet. It is made by allowing a molten dielectric to solidify in a strong electric field, and its electrization is so intense that it will last indefinitely without losing its strength if it is properly equipped with a "keeper."

Michael Faraday was first to recognize the fact that such a polarized dielectric can exist, and he recorded his findings in his "Experimental Researches in Electricity" in 1839. However, the word "electret" was never used until Oliver Heaviside wrote his "Electrical Papers" some years later.

Heaviside introduced the term to denote what Faraday had described as a "dielectric body which retains an electric moment after the externally-applied electric field has been reduced to zero." But, paradoxically enough, nobody bothered to find out whether a polarized dielectric could actually be fabricated for practical purposes until Mototaro Eguchi, professor of physics for the Higher Naval College of Tokyo, began experimenting in 1922.

Eguchi created what he called "permanent electrets" by using waxes as the required dielectrics. To explain the process, he stated:

"When an electric field is applied to a melted substance, the molecules or clusters of molecules (which supposedly contain electric doublets) orient themselves with their axis in the direction of the electric field—so that, when the melted substance solidifies, the molecules will retain their orientation in the immobile state, causing the substance to retain a permanent electric polarization."

The Japanese scientist claimed his electrets were "permanent" because they revealed no apparent diminution of their electrification in a period of three years, but we must assume that he used this adjective in the sense that we do when we speak of a "permanent magnet" because the law of molecular reactions assures us that the artificial polarization of any material will decay after a certain period of time. At present, it is definitely known that electrets have a minimum life of five years.

Edwin P. Adams, physics professor for Princeton University, originated what is probably the simplest method of producing

Discovered in 1924, the electret has remained almost an unknown quantity. Here is a full description of the mysterious wax block with its permanent charge of electricity, much like the permanent magnetization of the magnet.

electrets. (See Fig. 1) It consists of mounting two brass tubes coaxially in a bakelite form block, pouring molten wax into the space between the tubes, and connecting the tubes to the terminals of a rectifier which will produce a difference of potential of about 4000 volts when solidification of the wax occurs. The current should enter the inner cylinder and leave via the outer cylinder; and, if it is properly measured with a micro-ammeter, it will fall from a value of  $10^{-4}$  amperes when the wax is melted to approximately zero when the wax is hard and cold. The inner cylinder should be insulated, and both cylinders should remain connected for some time after the wax has apparently hardened, in order to allow the electret to become fully electrified.

An improved method of making electrets was originated by Wilfred F. Good and

J. D. Stranathan of the University of Kansas in 1939. (See Fig. 2.) It is better than the Adams' process because it enables the experimenter to utilize an oil bath to extend the time required to charge and cool the wax for as many as 24 days. However, it would be beyond the means of many experimenters because it necessitates the use of a resistance thermometer, a bridge with a continuously variable galvanometer contact, a photo cell, a relay system, and a field of strength of approximately 8000 volts per centimeter.

The charging currents that have been used in making electrets at various temperatures are indicated in Fig. 3. The currents were measured in most cases in accordance with the potential difference produced across a high-ohm resistor ( $10^9$  to  $10^{10}$  ohm) connected in series with the sample. But in at least one instance the current was measured by taking the charging-time curve of an air capacitor (50 to 2,000  $\mu\text{f}$ ) connected in place of the resistor. In all cases, the potential difference was measured with a one-string fiber electrometer. The tension applied to the system was furnished by dry cells, and in most cases it was equal to 118 volts.

It is possible to make wax electrets without melting the wax, but these units never attain maximum strength.

Curiously enough, an electret will not exhibit its highest strength characteristics for several hours after it has been fabricated (see Fig. 4); and, within a few days, its two surfaces will permanently exchange their positive and negative charges. The latter is probably due to a secondary piezoelectric effect which is maintained by the internal stresses in the dielectric. At any rate, it does not affect the usefulness of the electret.

Almost any wax can be used in making electrets, but experimenters currently seem to prefer a 50-50 mixture of rosin and carnauba wax. The Adams' formula called for 45 per cent carnauba wax, 45 per cent white resin, and 10 per cent white beeswax.

When and if electrets are utilized commercially, it seems likely that they will be made from a material that is more stable than wax, such as a good thermoplastic or even glass. It is a well-known fact that many materials will take the "frozen charges" which are found in electrets and magnets, but only a comparative few will create a consequent electric or magnetic field.

The keeper which will preserve the electrification of an electret may be provided simply by covering the electret surfaces with tinfoil or a similar material.

The electret should be particularly useful in the manufacture of radio equipment be-

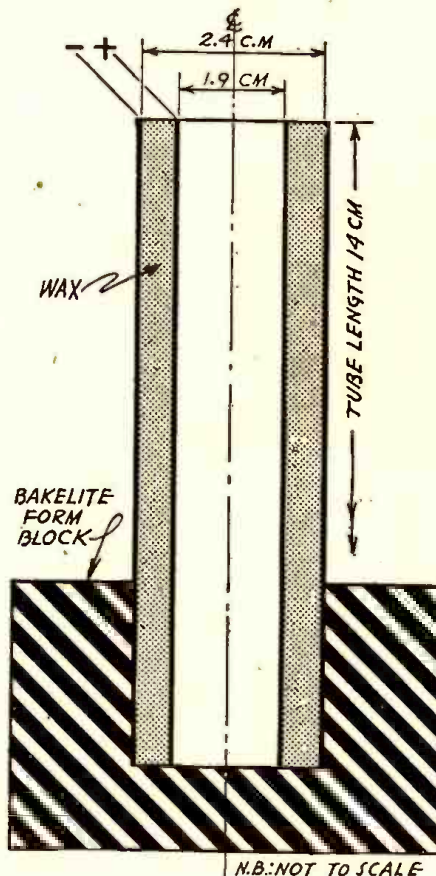

Fig. 1—Simple setup for making an electret.



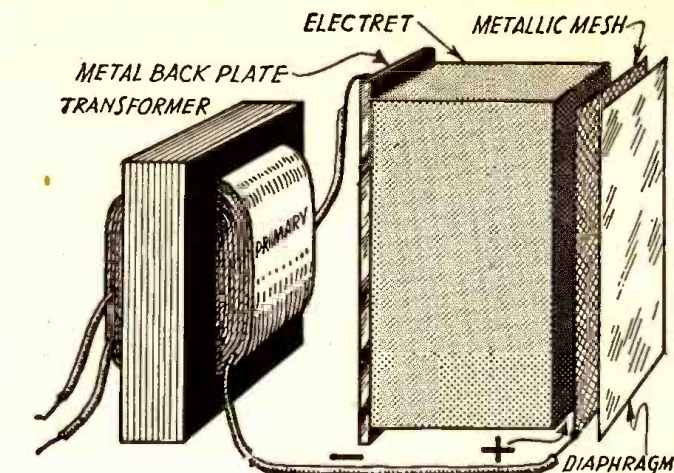
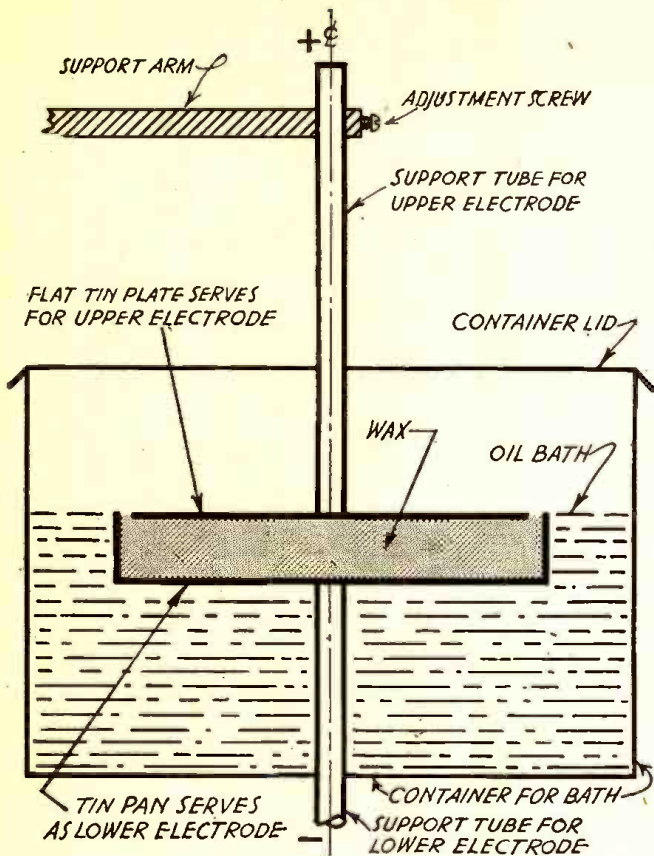

Fig. 2, left — Standard method of making wax electrets. Fig. 5, above — The electret-activated microphone.

cause its electrization is so intense that it will give the greatest sustainable value in the atmosphere to any electric force that is exerted on its front surface.

For example, one condenser-type microphone which makes use of an electret is already in existence. (See Fig. 5.) It was designed and constructed in 1935 by Andrew Germant for the engineering laboratory of Oxford University. Germant's description of the device reads as follows:

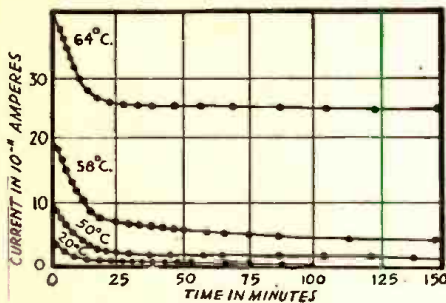

Fig. 3—Currents used in forming electrets.

"In this microphone, both the diaphragm and the metallic mesh possess a certain capacity against a free electret surface, and the ratio of their influenced charge depends

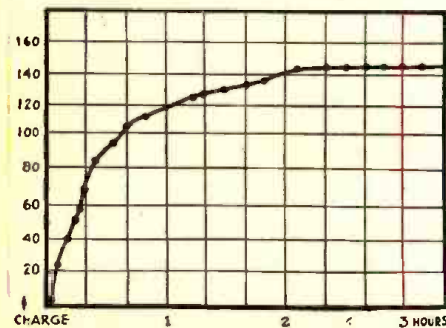

Fig. 4—Build-up of charge in new electret.

on the ratio of their partial capacities. Therefore, when the diaphragm moves, as the result of a sound wave, the capacity ratio will change and alter the charge ratio. An alternating current in the transformer, which for small amplitudes has the same wave form as the acoustical wave, causes the apparatus to function as a microphone."

Besides being extremely sensitive, this microphone can be used on a low-frequency circuit without a charging battery.

Electrets can also be used in making electrometers. For instance, in a string electrometer, the string could be stretched between pairs of electrets whose free surfaces (being positive and negative) would produce the necessary auxiliary field.

Further, an electrometer that is analogous to the mirror-galvanometer can be made by freely suspending an electret between two plates. Because it represents an electric dipole, this electret will be proportionally displaced when the plates are charged to the potential to be measured; and this potential can be determined in accordance with the displacement of the electret by means of a mirror and a scale. In one roughly-built electrometer of this type, a sensitivity of 0.5 volt per division has been observed.

The "keeper" previously mentioned is a piece of metal foil wrapped around to short the two polarized sides. This "short" prevents the charge from being dissipated in space, being exactly analogous in this respect to the piece of soft iron placed across the poles of a magnet for the same purpose.

Fig. 6 shows an experimental set-up that has been developed for the purpose of measuring the field distribution of electrets, and Fig. 7 indicates the field distribution near the electret surface which faces the metal plate in the test device. In connection with the latter illustration, it should be noted that the number of lines reaching the plate decrease with each increase of distance.

At the University of Wisconsin, experi-

ments are now under way to determine whether electrets can be used in making discharge tubes, cathode-ray tubes, photo tubes, and electrometer tubes. No results have yet been announced, but there are excellent reasons to believe that these efforts will produce great improvements in virtually all of our present electronic equipment. Measuring devices are the most likely, but not the only probable applications.

The electret is particularly significant in view of the Ehrenhaft magnetic current demonstrations,\* because it may ultimately prove the contention that electricity and magnetism are an indivisible pair. With our present knowledge of electrets and magnets, this proof seems inevitable. But it cannot be considered conclusive until scientists find out whether it is possible to duplicate the Ehrenhaft experiments\* with electrets in place of magnets.

\*The Ehrenhaft experiments were described in the March, 1944, and November, 1944, issues of RADIO-CRAFT.

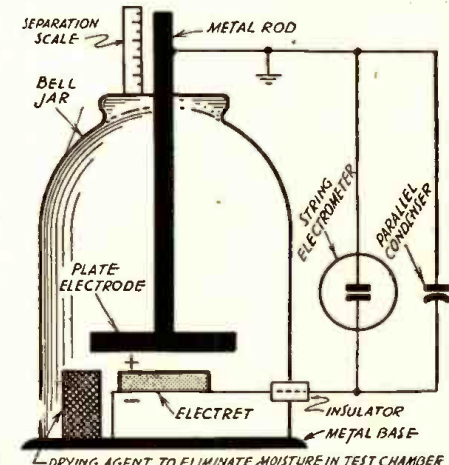

Fig. 6—Measuring electret's surface charge.

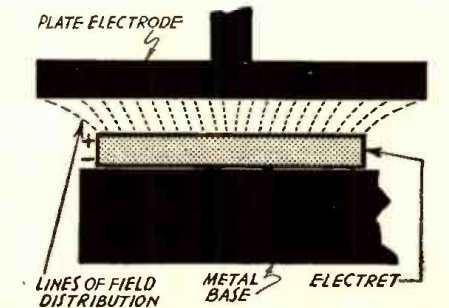

Fig. 7—Field distribution around electret.



# Licensing Problems and The Serviceman

By H. W. SCHENDEL

**C**ONSIDERABLE interest and comment has been expressed on the subject of licenses for radio and electronic servicemen. It is the intention of this article to discuss and summarize the various aspects, advantages, and disadvantages of licensing in its relation to radio and electronics.

It is generally agreed that some public control must be exercised to enforce health measures or to insure safety to life and property for large numbers of people. Safety measures are usually to help prevent major catastrophes such as fires.

Several professions and trades have been registered or licensed to varying degrees in various towns, cities, and states. Except in a few cases, practically all present groups are licensed for the main purpose of controlling health standards or safety to life and property. The automotive vehicle driver is probably the largest group under this heading. Other groups are physicians, nurses, pharmacists, lawyers, engineers, plumbers, electricians.

Groups which have been or are licensed, or are presently contemplating licensing, for purposes not especially involving public health and safety include; radio servicemen, painters, horologists, photographers, and others. Numerous similarities, such as amateurs, irresponsible individuals, and other claims, practically all the same ones as made by proponents for licensing of

radio servicemen, may be noted to exist between radio servicemen and the others listed.

AM, FM, and television reception, in the common forms with which most servicemen are concerned, usually have been considered primarily a form of entertainment. This gives rise to classifying the radio servicemen with the groups just mentioned. Radio and electronics used for safety to life and property will be discussed later.

It is true that the public is in contact with these groups but the monetary values involved are relatively small and the danger to human health and life from an error in diagnosis and repair is either non-existent or, at least, no greater than the danger from other household apparatus and appliances such as electric flatirons, toasters, gas ranges, washing machines, and others.

In some cases serious accidents and fires have been attributed to defective radios, oil-burners, and refrigerators but it is doubtful if these accidents and fires have been as much the fault of the servicemen than the fault of the user. It would be interesting to determine whether or not licensing servicemen would reduce such hazards as long as the average domestic user must decide whether and when check-ups and repairs should be made.

Some hold that where electrical codes are involved and enforced the electrical

H. W. Schendel first started working with electricity 23 years ago, repairing appliances and rewinding motors and transformers. Starting to build and repair radios as a spare-time hobby, he decided



that he needed more fundamental knowledge and chose an electrical and radio engineering course.

Gaining more practical experience after graduation by working at the service bench, he then obtained a position drafting and designing electronic and electric apparatus.

His keen interest in the amateurs' and servicemen's problems has its origin in his own experience. At present convalescing from a disabling illness, his activities are limited. He is 39 years old.

## Cover Feature: Radar in A.A. Gunnery

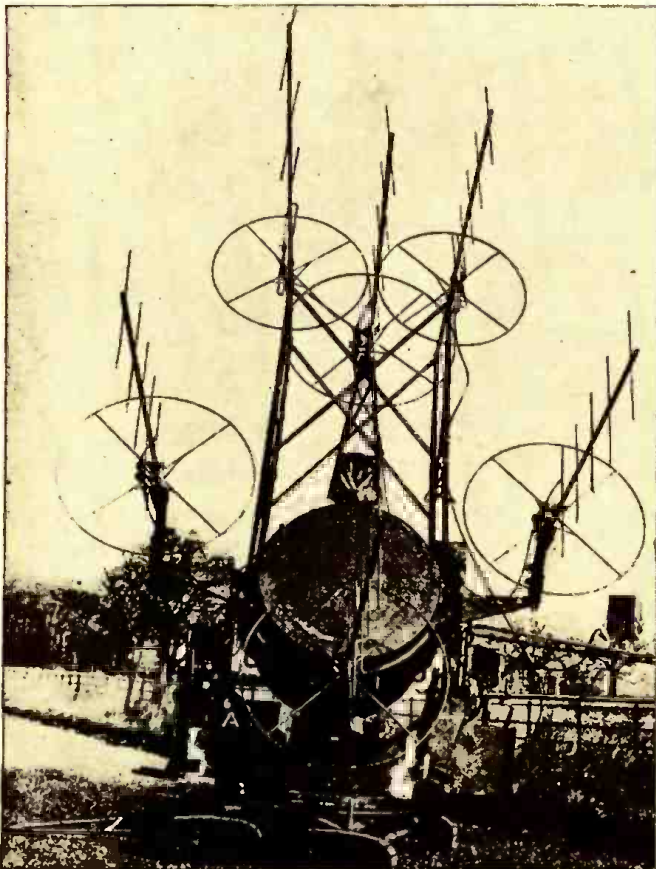

The cover picture shows a modern radar controlled searchlight equipment which was of great assistance to British Army anti-aircraft gunners and to the Royal Air Force in shooting down night bombers and which was also extensively used during the flying bomb attacks in 1944. Radar has developed far from the simple defensive range- and direction-finding apparatus it was at the beginning of the war. While without doubt the simple "A" scope won the Battle of Britain — and thereby, in all probability, the war — later offensive devices made decisive contributions. These included radar range-finders for guns, for locating enemy surface and undersea craft from both air and sea, aircraft attachments by which night fighters could locate enemy raiders, and bombers could bomb accurately through cloud, unseen from the ground below.

inspector has the power to inspect and require removal or repair of definite hazards. The owner is usually held responsible even though licensing has been established. (For a minimum standard, most codes use the National Electrical Code as a basis and thereby also include radio and electronic equipment, and aeriels and grounds.) Baltimore was considering an ordinance very similar to the Madison ordinance (to be described later) to license radio and electronic servicemen but shelved it because existing ordinances regulating electrical work were considered to give all protection necessary.

Some states—Oregon, New York, California—have had proposals under consideration also for the purpose of licensing radio and electronic servicemen. These proposals have been temporarily shelved or rejected for various reasons.

In so far as safety applications of radio and electronic devices are concerned—on machines, airplanes, ships, in police cars, ambulances, and many other places—the public has come to depend on them and it is necessary that these devices be serviced by competent repairmen. To this end some regulations, like those for ship radio operators, broadcast station operators, and others, have been placed in effect and qualified men are selected.

Undoubtedly, properly examined and licensed servicemen would be qualified to service many of the foregoing applications and would receive public approval and support if good examining standards were established. If such is the case then a question arises as to whether or not all servicemen should be licensed before being permitted to service any and all kinds of radio or electronic apparatus and devices.

### THREE SETS OF OPINIONS

On this question servicemen may be classified in three groups: Those who favor compulsory licensing for all; those middle-of-the-roaders who prefer voluntary licens-

(Continued on page 105)



# BETATRON— Atom Smasher

By O. JOE OLSON\*

**T**HE BETATRON is modern science's newest and, in many respects, most-amazing atom smasher. With the world on the threshold of an "atomic age," the betatron is regarded as the key that will unlock many close-held secrets of nature.

The betatron is a complement to both the cyclotron and the Van de Graaff generator. All three are atom smashers.

The betatron accelerates electrons, the lighter, satellite parts of atoms. An electron is approximately 1/2000th the weight of its atomic counterpart, the proton; the two kinds of atomic particles have opposite electrical charges—the electrons, negative, the protons, positive.

The cyclotron, on the other hand, is used to accelerate only heavy ions, the massive

Close-up of the Ohio State 4½-million volt betatron, showing the magnetic coils as well as the doughnut-shaped tube in which the electrons whirl.

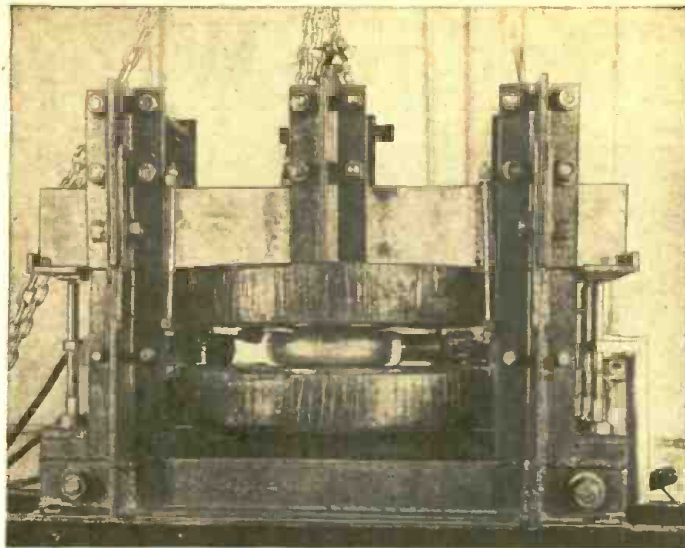

volts. As a matter of fact, at 10 million volts, the betatron can be said to be "just getting warmed up."

Of these three types of atom smashers, the betatron is the lightest in weight and the most compact in size for a particular output energy. While no less complicated in design and construction, the betatron is less costly to build than either of the other

better and better insulators for standard type machines. To refresh the memory of the reader: Only 35 years ago—in 1910—a 500,000 volt transformer was spectacular. Twenty years ago a million volt potential was a World's Fair "super attraction." Although 5-million volt surges were manufactured in impulse generators as early as 1928, it was only some 10 years ago that continuous current beams of 5-million volts were produced and these by the Van de Graaff generator. This type of machine actually is a refinement of the old, familiar Wimshurst electrostatic generator to be found in any high school laboratory.

Then came the cyclotron and, five years ago, the world's first betatron. Today a 100-million volt electron beam by means of the betatron is a fact. Not only is this a reality but the betatron which now can

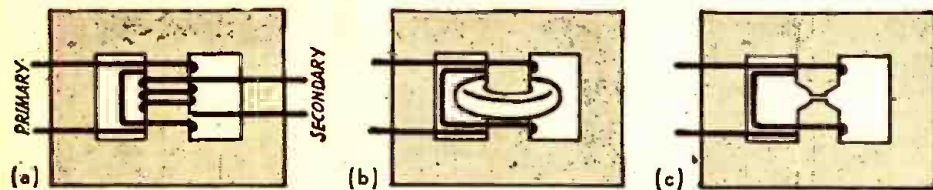

Fig. 1—(a) Ordinary transformer; (b) transformer with an evacuated electron accelerating chamber replacing secondary; (c) chamber removed to show air gap and tapered pole faces.

particles in the nuclei of atoms (including protons), and is incapable of accelerating electrons. The Van de Graaff generator can accelerate both electrons and heavy ions but it does not compete with the betatron for the reason that the upper limit of energies obtainable with the Van de Graaff generator, in accelerating electrons, is below 10 million volts whereas the betatron's range extends into hundreds of millions of

two types of machines (again taking into consideration the voltage output of the machine contemplated).

As readers of *Radio-Craft* may know, the problem of insulation has been the chief limiting factor—the bugaboo—in the construction and development of high-voltage generators.

Since the age of electricity first dawned, the extension to higher and higher voltages has been a relatively slow process because of the difficulties encountered in finding

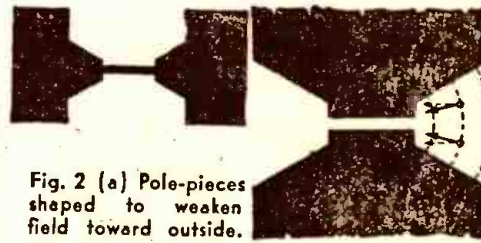

Fig. 2 (a) Pole-pieces shaped to weaken field toward outside.

(b) Section showing forces acting on electrons above or below the median plane.

produce the equivalent of 100-million volt electric potentials gives promise of billion volt potentials!

Essentially the betatron is a rough equivalent to a high-voltage transformer. However, in the betatron the customary metallic secondary conductors are replaced by a toroidally shaped (doughnut-shaped) evacuated chamber (See Fig. 1). The evacuated chamber, or doughnut, is placed around the central leg of the transformer core and in this chamber the electrons race their circular orbit in space. The core leg is split (See diagrams and photograph) to accommodate the doughnut, and the pole faces of the core just above and below the doughnut are tapered to provide the exact field-flux spatial relations that are essential for the simultaneous confinement and acceleration of the electrons.

Electrons injected inside the doughnut are picked up and accelerated by the electric field which is associated with the time-changing magnetic flux of the primary.

The force resulting from the interaction  
(Continued on page 126)

Dr. Drees and Dr. Theodore Wang, of Ohio State University, inspecting the Betatron, which was designed and built by Dr. Wang.





# Boat Radio Installations

Small-craft transmitters and receivers present their own problems, which are stated in the article below, with a number of working methods and kinks for their solution.

By HENRY B. O. DAVIS

WITH hostilities over, the thoughts of many small boat owners are turning to the possibility of improved radio installation for their boats when they are again available for pleasure use. Installation and maintenance of this equipment can be a profitable source of income for radio service men in coastal areas or inland on rivers and lakes used by pleasure craft.

A good shipboard radio installation is more than an artistic arrangement with neat or concealed wiring. It is assumed the arrangement will look well and be convenient for the operator. Signals should stand out well above the noise level at normal or somewhat above normal speed. It is not unusual to find boats equipped for two-way radio communication which can operate only with the engine shut down. Silencing the electrical noise and as much as possible of the mechanical noise will require most of the time on each installation.

Installation of radio equipment on boats will, in general, be found much more difficult than on automobiles, although automobile experience will be of great value. In the automobile the engine is almost

completely surrounded by metal, more or less confining the noise field. On smaller boats the equipment and antenna must of necessity be very close to one or more unshielded gasoline engines, larger and more noisy than those found in automobiles. While many of the newer boats will be coming out with shielded ignition systems, many unshielded engines are still in use and will be for some time to come. It is these older engines that give most of the trouble from noise.

## PLANNING THE INSTALLATION

The serviceman may be called to install material on hand or recommend new equipment. With as much information on hand as the owner can give, a survey of the boat will give much additional information. This survey should include a study of the following:

1. The operating position
2. Antenna possibilities
3. Power available
4. Engine inspection
5. Electrical equipment
6. Electrical wiring
7. Grounding and bonding

The owner will usually have in mind where he wants the apparatus located. On the majority of the smaller boats the skipper will also be the radio operator and will require the equipment to be within easy reach while cruising. If a radio operator is to be carried, the apparatus may often be located in a position farther from the engines. Where the receiver is installed near the control board on boats under forty feet, it will usually be near the engines and in a position likely to be in a strong noise field, which cannot be cut to any great extent.

This calls for a well-shielded receiver capable of being heard above the high mechanical noise level of one or two engines.

The radio compass, if any, will be located in a convenient position for navigating.

## ANTENNA POSSIBILITIES

In looking over the boat for a good antenna location we will no doubt come to the conclusion that there isn't any. In any case the antenna will have to be electrically short unless the higher frequencies only are to be used. Several possible arrangements are shown in Fig. 1.

A relay may be connected to shift the antenna from receiver to transmitter and thus use only one antenna. If separate antennas are to be used they should preferably be at right angles to each other, although this is not always possible. A vertical whip for receiving and a horizontal L or T for transmission is a very satisfactory arrangement.

The horizontal antenna, whether for transmitting or receiving, should be as high and in the clear as possible to prevent or reduce absorption by ventilators or rigging while transmitting and to allow maximum signal pickup with minimum pickup from the electrical apparatus and engines. The antenna on small boats will usually be as long as space will permit; this will be about the length of the boat. Low capacity shielded lead or coaxial cable may be necessary to prevent noise pickup in the lead to the receiver.

## POWER AVAILABLE

In checking on the power available, a glance at the light bulb will show the power supply voltage. The battery nameplate may give the ampere-hour capacity; if not an estimate will have to be made from the size of the battery. The voltage is usually 6, 12, 32, or 110. Larger boats using 32 or 110-volt systems are usually equipped with battery-charging generators driven by small gasoline engines.

In smaller boats with 6- or 12-volt batteries the charging is done just as on automobiles, by a small generator which charges only when the engine is running. This arrangement is not well suited for the added load as the battery may go down and fail to start the engine when needed most. A

(Continued on page 136)

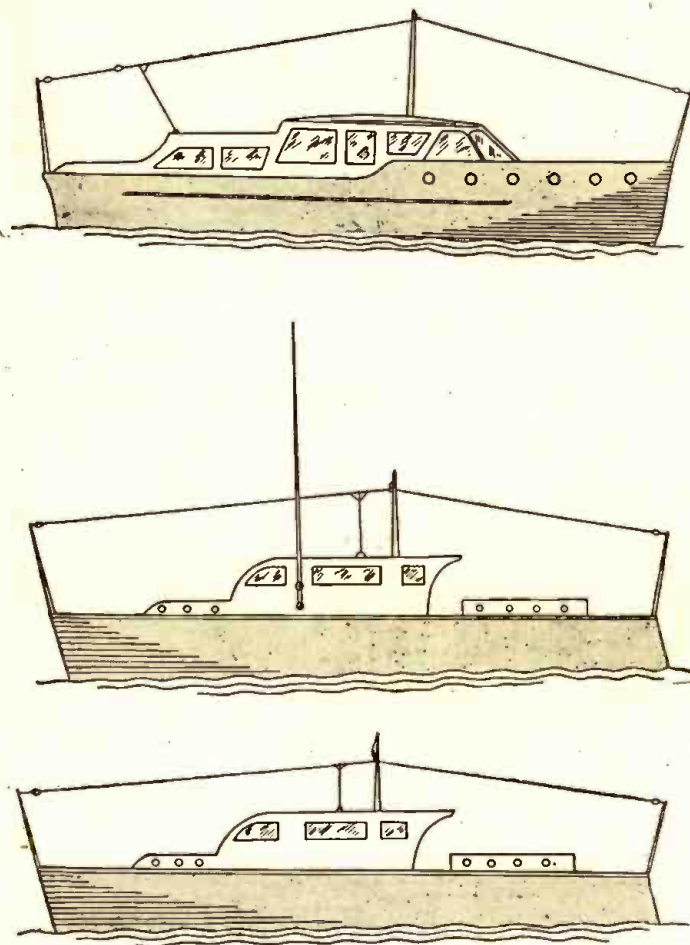

Fig. 1—Several practical types of antenna installations. Top is an "L" antenna, most common on short craft. Middle is a "T" transmitting and "L" receiving, and bottom a straight "T" aerial.

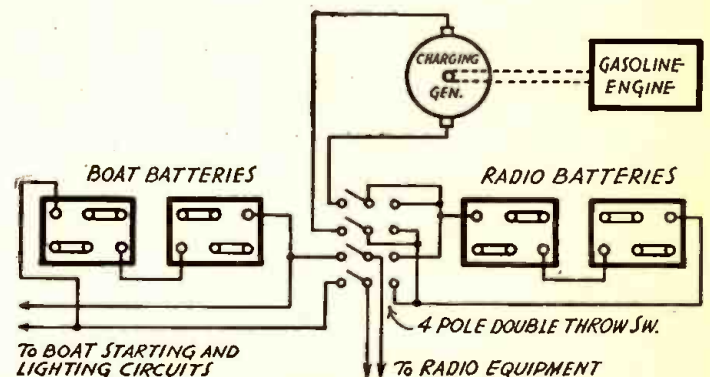

Fig. 2—Battery charging equipment and switching layout.



# RADAR INDICATORS

The indicator is the only means a radar has of communicating to the operator the information it has obtained.

By MAJOR EUGENE E. SKINNER

ALL radar sets are equipped with an indicator to furnish the radar operator with certain information. This may be only the distance to the target and its direction, or may be much more elaborate, including such information as the number of degrees above or below (in nightfighters), the number of degrees to the right or left, relative positions with regard to land, islands, friendly vessels or aircraft, other enemy targets, and even the point at which the bombs should be released on the "Mickey" bombing set.

Practically all radar sets use one or more cathode-ray tubes as indicators. In a radar set, this indication is visual, and parallels the use of a loud-speaker in an aural radio receiver.

The most basic type of indicator is known as an "A" scope, and is generally used to show range. This scope has a luminous line, known as the sweep line or time base line, across it horizontally. The point at the extreme left represents the position of the radar set. It is calibrated as to range so that the extreme right of the line indicates maximum range. On a scope of this type, there is an inverted V at the beginning of the sweep line, which is caused by a small bit of power from the radar pulse transmitted being fed directly into the receiver, and occasionally from echoes that return from objects so close in as to be indistinguishable from the transmitter pulse indication. At positions along the range scale, other inverted V's or signals appear. Figs. 1 and 2A show the front of such an indicator which has two ranges, 20,000 and 100,000 yards. The basic method of obtaining such an indication is as follows: Two sets of signals are fed to the electrostatic plates of a cathode-ray tube. The pair of plates in a horizontal plane have fed to them a varying voltage that causes a line to be drawn across the scope. This voltage is usually as nearly linear as is possible, and may be obtained by taking a segment of a voltage versus time curve of a condenser charge or discharge through a resistor. By using the proper proportions of resistance and capacitance this curve may be varied, and different ranges obtained thereby.

As a pulse is sent from the transmitter, the sweep line across the cathode ray tube is triggered off. As the pulse goes through space, striking the target, and is reflected back, the sweep line continues to move across the scope face. When the reflected pulse has gone through the receiver to the indicator, it is fed to the vertical pair of electrostatic deflection plates, causing a deflection, or inverted "V", to appear on the sweep line. The sweep line is not a smooth one, but is "grassy" or ragged because of "noise" in the equipment. Transient flashes are caused by static. The speed of the radar pulse through space is fixed, and is known. It is then necessary to decide what range

scales are desired, and adjust the sweep voltages of each so that, for example, the return from a target twenty miles away shows up on the scope at the point marked "20 miles." Merely by turning a selector switch, different preset ranges may be obtained. Screwdriver adjustments control the "zeroing" for vertical and horizontal position on the tube face, and manual controls of focus and brilliance are included.

A variation of this scope is the vertical "Double A" scope, which has two of the above described "A" indications placed together on the same tube. This type of scope is used in a set which has two receiving antennas, one covering the area to the right front of the plane, and the other the left front. Thus, if the received signal is of equal strength on each side of the time base line, the target is directly ahead, and at the calibrated range. If the return is on one side of the time base line only, the target is well

to, that side of the heading of the aircraft carrying the radar set. Approximate angles to the target may be obtained by comparing the relative strength of the signals to the

(Continued on page 132)

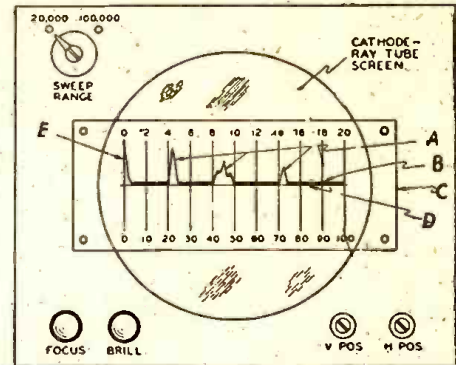

Fig. 1—Appearance of the "pips" indicating distance of objects from the radar equipment. A—Echoes received from objects at different distances. B—"Grass," echoes returned from land or water. C—Transparent scale, two calibrations in thousands of yards. E—Echo received from plane or ship itself.

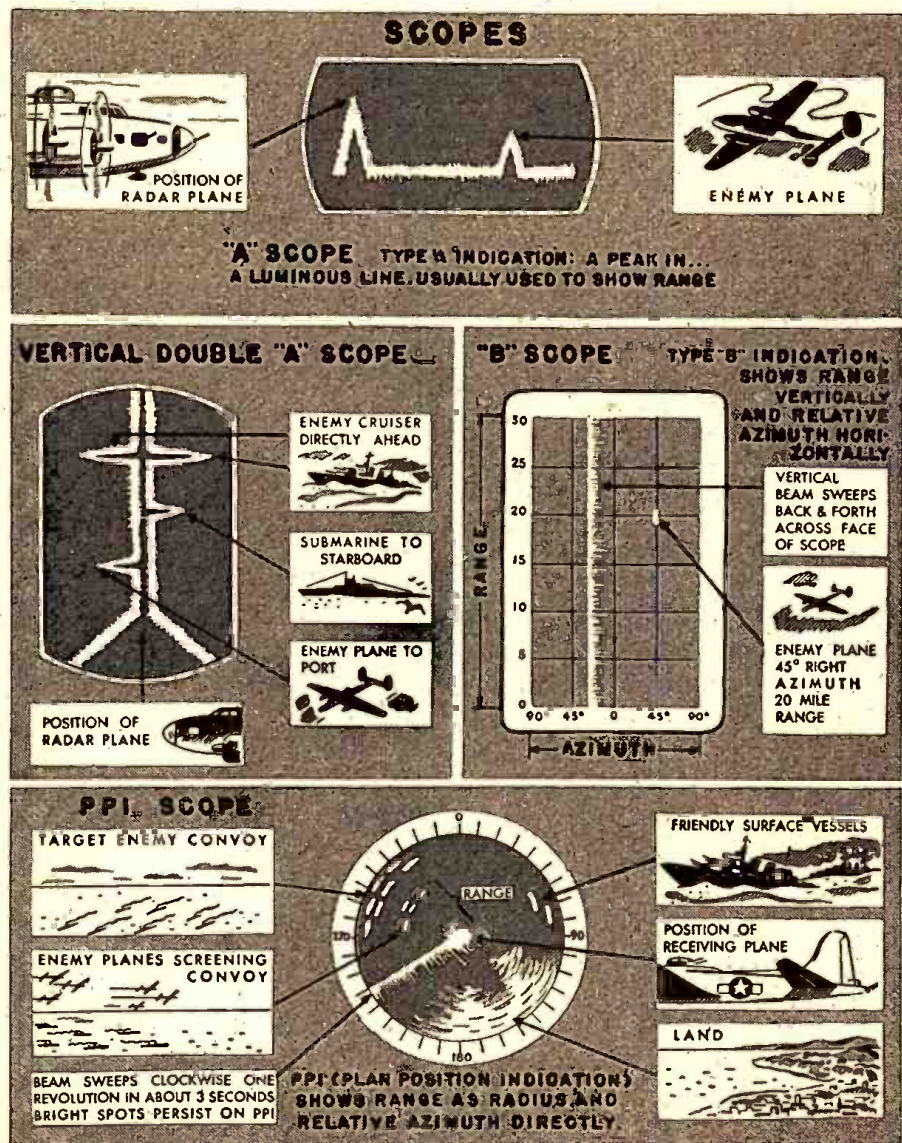
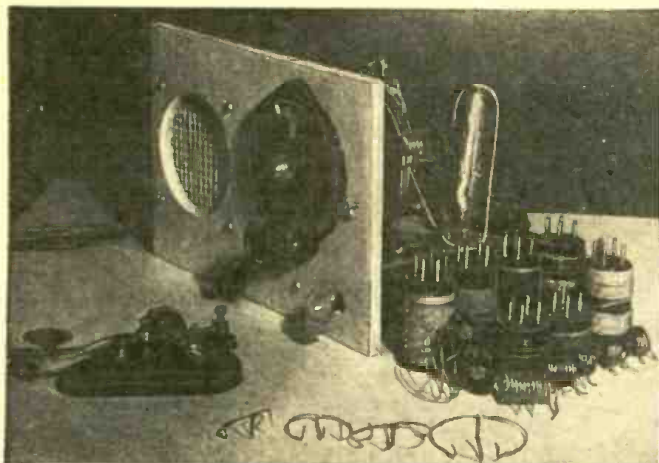
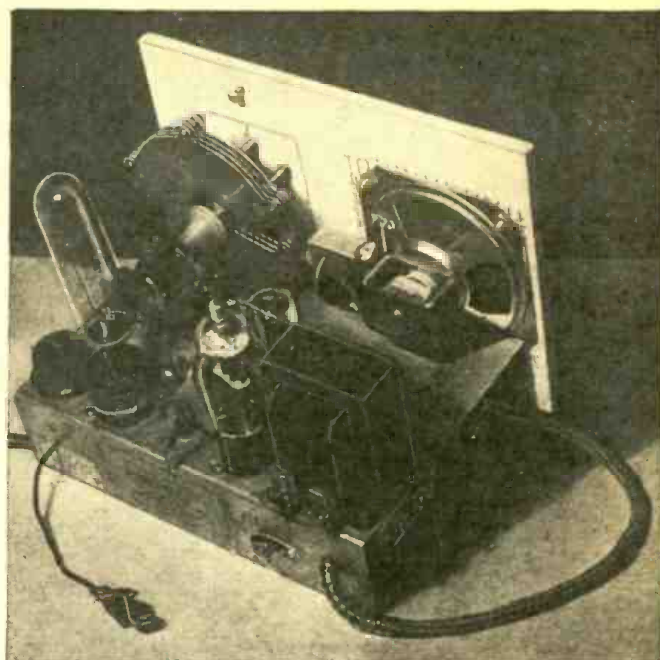

Fig. 2 A, top—Positions of objects shown in the "A" scope. B, center left—Pips on a vertical "double-A" scope. C, center right—A "B" scope, showing the range and azimuth. D, bottom—PPI, or Plan Position Indicator.





Front and rear views of the "Explorer 3" plug-in receiver.



# EXPLORER ALL-WAVE RADIO

By BOB WHITE

**T**HE 3-tube receiver described in this article has a tuning range from 4½ to 665 meters. It consists of a two-stage audio amplifier, which provides loud-speaker volume on all signals, and which also operates as a code practice oscillator; a regenerative triode detector of the grid leak type; an untuned R.F. amplifier; and a half-wave rectifier. The "Explorer" has good selectivity, and is a real-distance getter on both short-wave and broadcast bands.

## CONSTRUCTION DETAILS

The receiver was built on a chassis which measures 9 x 6 x 2 inches. The front panel can be made of wood if it is lacquered and shielded. The pictures clearly show how the parts are mounted. The volume control (R3), the regeneration control (R6) and the vernier tuning dial (C11 and C13) are operated from the front panel. The R.F. gain control (R9), the trimmer condenser (C16), and the "U"- "S" switch, which are adjusted only when

a plug-in coil is changed, are accessible from the back.

The cylindrical light bulb is superior to the ordinary lamp because it does not take as much space. The center contact should be connected to the filaments, and the outer screw-in contact to the chassis. A 250-ohm 25-watt resistor can be used in place of the lamp if desired.

The audio amplifier of the receiver will also operate as a code oscillator. The volume control is connected in such a way that it will act as a pitch control when the oscillator is in use. The pitch of the oscillator depends upon the value of condenser C7. A .1 mfd. condenser should be used if bass tones are desired, or a .01 mfd. condenser if treble tones are preferred. The volume control does not reduce the strength of an in-coming signal to a very great extent until it is almost off; therefore, it is possible to make it operate as a tone control also. This is done through the use of a fixed tap and condenser C5. Static and other disturbing noises can be

reduced also by using the tone control.

The bias for the grid of the first audio amplifier tube is obtained through the use of a single 1½-volt flashlight cell. This cell should last almost indefinitely.

The primary of the audio transformer and the chassis are connected to three Fahnestock clips. This attachment makes it possible to connect supplementary detectors or other external experimental devices to the audio amplifier and to also use the "B" supply in external circuits. When such devices are connected to the amplifier or "B" supply, the plug-in coil should be removed from its socket. Care should be taken to see that the device is not grounded or directly connected to the power line.

The plate and grid leads of the detector should be made as short as possible. The grid leak resistor is of a low value so that the detector will not overload on strong signals. The "U"- "S" switch can be a S.P.D.T. switch or an insulated single jack with two cord tips. The special two-gang tuning condenser was made from two old

(Continued on page 134)

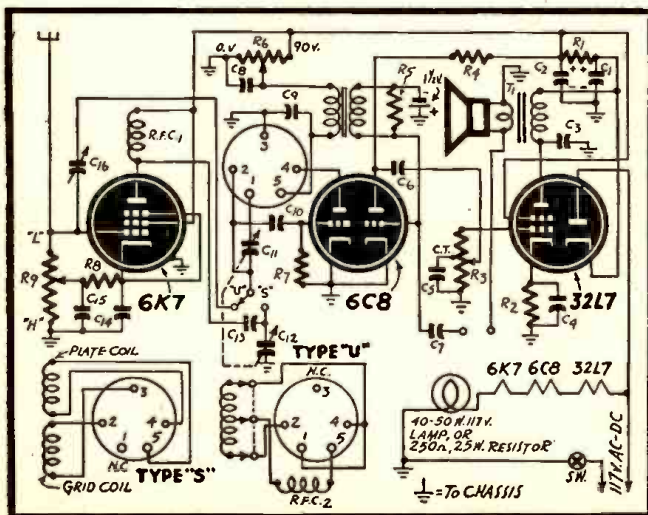

Schematic shows how switching and plug-in are combined.

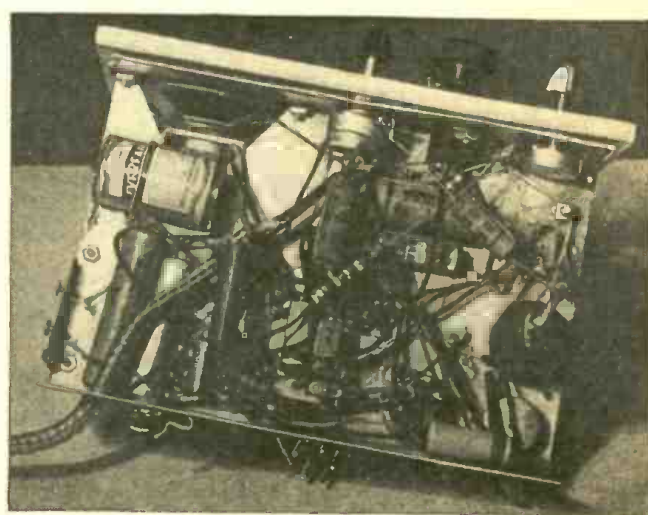

Simplicity of the under-chassis wiring may be seen above.



# A TRUE TONE CONTROL

A genuine tone-compensating circuit which can be calculated by the designer himself to fill his own requirements for radio amplifier, P.A. system or phono record player.

By GEORGE BERTSCHE

THERE have been, in the past, many so-called tone control circuits that employ by-pass or "tone control" condensers to reduce the treble response and thereby create the effect of bass boost. This usually resulted in a deep muffled tone mistakenly accepted as bass boost or treble attenuation by the average listener. However, the tone enthusiast was not misled. He would invariably attempt to design his own circuit, sometimes—after long hours of labor—achieving favorable results.

The prime purpose of this article is to explain to the average tone-fidelity seeker the procedure to be followed in calculating values necessary to satisfactory tone quality. It is much easier and more efficient to be able to plot out the exact values required before attempting to wire or construct. Once this has been done, the actual wiring in of the circuit is mere child's play.

Due to its simplicity of action and near-conventionality, anyone in need of a dual tone control circuit can work out their own variations of the type of circuit shown in Fig. 1. This incorporates all the conven-

In the original design, the response curves, Fig. 2, were first calculated approximately and the effect of the treble portion of the network was omitted when calculating the bass section curves. This treble portion had a shunting effect, reducing both the attenuation and boost. The bass condensers were then halved in value in an attempt to move the bass curves, bodily, one octave higher. A corresponding improvement in tone was immediately apparent.

In the design of the network, the boost should approach 15 db. This means that the loss through the network should be reduced by tending to run "straight through" to accomplish boost. The attenuation is brought about by conventional methods; treble by parallel reactance, bass by series reactance.

In Fig. 1, the output or "loss" at normal or at middle frequencies is determined by the ratio of  $R_1$  and  $R_4$ , so  $R_1$  and  $R_4$  were chosen to provide 15.5 db. attenuation or an output one-sixth the value of the input.

The capacitors were originally chosen more or less at random, and the response curves drawn. From the resultant curves, more suitable values were chosen to provide a better response, designing by the cut-and-try method. However, the unit was not constructed till it was perfected on paper, and it was therefore not necessary to change the values after the final construction as the tone was perfect, and it followed the curves pretty closely.

The formula for determining the values of the various components is merely an application of Ohm's law for multiple series-parallel circuits to find the fraction of the input reaching the output. This fraction is converted to db. loss in the circuit, and then to db. output on the basis of 15 db. input. A 15 db. input is chosen because the 250,000 and 50,000-ohm resistors alone would cause a 15 db. loss in the circuit, making the output 0 db.  $E_1/E_0 = :$

itive reactance:  $X_c = 1/2\pi fC$ , of each condenser, the equivalent resistance of the entire network can be calculated in this manner. See Fig. 3. Then it is merely another application of Ohm's law to find the total resistance of the input half of the circuit as compared to the output half of the circuit. Then  $E_1/E_0$  will give you the amount of voltage gain or loss.

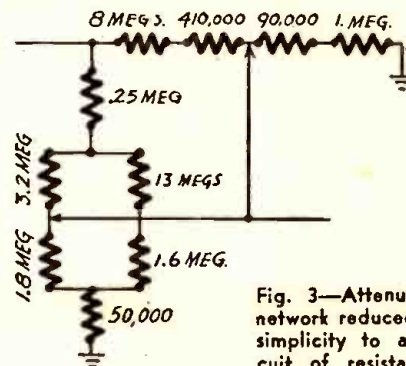

Fig. 3—Attenuation network reduced for simplicity to a circuit of resistances.

Since,  $E_1/E_0$  equals 5.3 in our example, and since db. equals  $20 \log_{10} E_2/E_1$ , we can calculate the loss in the circuit. The fraction  $E_2/E_1$  would be less than one, and since there is no log of a quantity less than one,  $E_2/E_1$  must be inverted, making the result a negative quantity, thus indicating a loss. The formula for the revised situation then is  $-db.$  equals  $20 \log E_1/E_0$ . Substituting the 5.3 for its equal  $E_1/E_0$ , we find the gain in the circuit is approximately 14.5 db., or the loss is + 14.5 db. Since we assigned to  $E_1$  a final value of 15 db., the output is 14.5 db. lower or the final output is actually 0.5 db., which is a relative rather than an absolute value. It is this value which determines the operating point on the graph. Place a point on the graph, Fig. 2, at the intersection of the 25-cycle abscissa and the 0.5 db. ordinate. This point helps to determine a curve depicting the relative output in db. (along with many other similarly found points) for varying frequencies with the controls normal. For

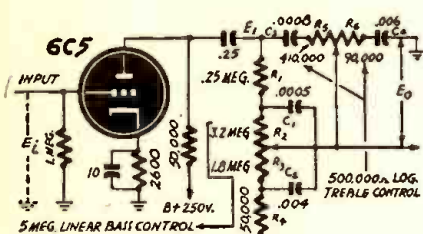

Fig. 1—Basic circuit of tone control system.

tional features of the standard "controls" and in addition has considerably less phase shift (almost none when normal). It also has fewer parts than the standard circuit, smoother and wider control over a given band of frequencies, and greater gain throughout the entire stage.

In practice the desired response curves were first drawn and the circuit and components calculated from these curves. (The condenser sizes should not be changed, as they determine the response of the circuit.) The position of the control for "normal" can be calculated from the graph of the control's taper. The bass control in this case was "normal" at 40 per cent rotation of the shaft, and the treble control was in the normal position at 60 per cent rotation.

A type 6C5 tube precedes the control, with a low load resistance to provide constant voltage output. The bass tone control is 5 megohms with a linear taper. The treble control is .5 megohms with a logarithmic taper.

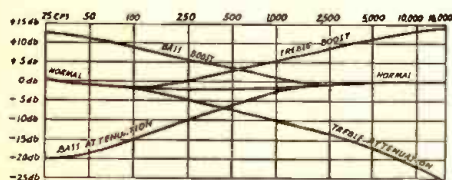

Fig. 2—Control circuit attenuation curves.

$$\frac{\left(\frac{R_2 X_{C1}}{R_2 + X_{C1}} + .25\right)(X_{C2} + R_5)}{\left(\frac{R_2 X_{C1}}{R_2 + X_{C1}} + .25\right) + (X_{C2} + R_5)} + \frac{\left(\frac{R_3 X_{C2}}{R_3 + X_{C2}} + .05\right)(X_{C4} + R_6)}{\left(\frac{R_3 X_{C2}}{R_3 + X_{C2}} + .05\right) + (X_{C4} + R_6)} = \frac{\left(\frac{R_3 X_{C2}}{R_3 + X_{C2}} + .05\right)(X_{C4} + R_6)}{\left(\frac{R_3 X_{C2}}{R_3 + X_{C2}} + .05\right) + (X_{C4} + R_6)} \dots (1)$$

The first step is to find the value for the fraction  $E_1/E_0$  or the attenuation in the circuit.  $E_1$  is the voltage input and  $E_0$  is the voltage output. To find this fractional figure, the variables must be assigned values. Let the assigned frequency be 25 cps; let the controls be "normal." Then the condensers are "replaced" in the calculations with equivalent values of resistors for this frequency. By substituting the capaci-

other frequencies with the controls normal, the only things that are changed in Fig. 1 are the reactances,  $X_{C1}$ ,  $X_{C2}$ , etc. For other positions of the controls  $R_2$ ,  $R_3$ ,  $R_5$ , and  $R_6$  are varied. For example: with full bass boost,  $R_2$  is set at zero and  $R_3$  at 5 meg.

The similarity between the voltage divider formula  $E_1/E_0$  equalling  $A + B/B$  (Continued on page 123)



# Dynamic Handful Signal Tracer

By RALPH BLOOM

**T**HE unit to be described is intended for radio servicemen who are too busy to construct an elaborate signal tracer or audio amplifier.

This tracer was designed primarily to do away with power transformers, external test probes, specially constructed test prods, coils, tuning condensers, tap switches, external amplifiers, high cost of construction, and to save valuable space on the service bench.

There are no special parts to be obtained and it takes very little time to build the tracer. It is so small that it can be placed inside your toolbox together with your other tools.

The volume of the signal tracer is adequate even when connected only to an antenna circuit. Very little hum is

noticed when operating it. The open space on the front panel of the tracer lets the heat of the tubes out, indicates when tracer is on by the tubes lighting up, eliminating a pilot light, also provides a space for the line cord if you intend to carry it with you on service calls.



Front view of the hold-in-hand signal tracer.

The tracer was assembled on an A.C.-D.C. very small midget radio chassis which

was cut in half, leaving the four tube sockets and speaker already mounted, besides the wiring of the output tube and rectifier, which was left intact (because it is usually standard on all midget receivers), thereby saving quite a bit of the work involved by not having to cut tube socket holes, speaker cutout and considerable wiring. There are several well-known makes of midget radios from which the chassis can be cut to leave four tube sockets and a speaker cutout remaining. If a small set cannot be obtained, a chassis layout is illustrated so that the serviceman can cut the chassis himself.

## ANY TUBE COMPLEMENT

The serviceman can have his choice of tubes to be used in the tracer. I use a 12Q7, a 12SQ7, a 50L6, and a 35Z5 tube. These were the tubes I had on hand at the time of construction. However, if the serviceman desires, he can use a 12F5, a 12SF5, a 50L6, and a 35Z5 or a 45Z5; or if those tubes are not available, he can substitute a 6Q7 or a 6F5, a 6SQ7 or a 6SF5, a 25L6, and a 25Z6, in which case he will have to use a line cord resistor to drop the voltage for the tube filaments.

The filaments should be wired as shown with tube No. 1 filament connecting to ground to prevent hum.

The tubes are used in this order: 1—untuned detector; 2—1st audio; 3—output; 4—rectifier.

Various circuits were tried such as using 12A7 as an untuned R.F. stage into a 12SQ7 diode plates as a diode detector, into the triode section of the 12SQ7 as first audio, but the results were not as good as the circuit shown.

## HOW TO OPERATE THE TRACER

The tracer is so sensitive that it is not even necessary to touch an I.F. or audio grid or plate—just place the prod near the grid or plate and you can pick up a signal, the volume depending on which stage you are testing. In service work I have found

this tracer capable of picking up a signal over 3 feet away from a dead set which

Ralph Bloom is a practical serviceman from Brooklyn. Twenty-eight years of age, he claims to have spent the last seventeen of them "in radio" working up from the crystal-receiver stage to that of Service



Manager for the Municipal Radio Co., in his native Brooklyn. He originated his signal tracer as a means of more speedy servicing, because he "felt the need of a small, simple instrument which would not require the time needed in constructing and using one of the more elaborate jobs." The result of his efforts to produce something simpler and quicker are described in this article.

had an open voice coil in the speaker. I have been using this tracer for one year on the service bench, and find it very useful since I do quite a bit of repair work on radios and phonographs, and this tracer being so small it doesn't take up any room at all on the bench.

Stage gain can be checked by touching the grid and then the plate of every stage working toward the speaker.

An isolation transformer is unnecessary because of the blocking condenser in the circuit. The volume control controls the volume of both the R.F. or audio amplifier sections of the signal tracer.

To operate tracer, plug into electric outlet, touch antenna to prod A on top of tracer; if several stations come in at once, then it is all set. If a loud hum is noticed, reverse plug in outlet.

Testing procedure will depend on whether set is inoperative or is noisy or fading. If set is inoperative, the short prod is used which consists of nothing more than a phone tip with a nail soldered to it. The tracer is held in the hand because it only takes a few seconds to touch a grid or plate terminal of a socket to determine if that stage is working properly.

If set is noisy or fades, tracer can be (Continued on page 113)

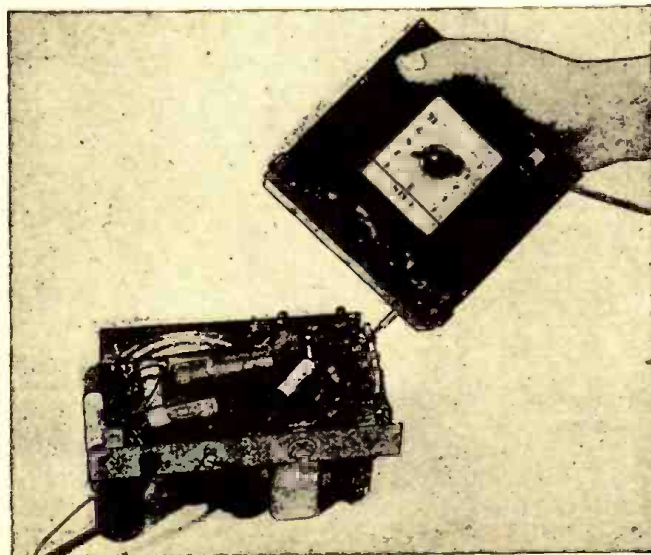

Left—The tracer is inserted in the radio exactly like a probe. Below—A schematic diagram of the "Dynamic Handful" tracer.

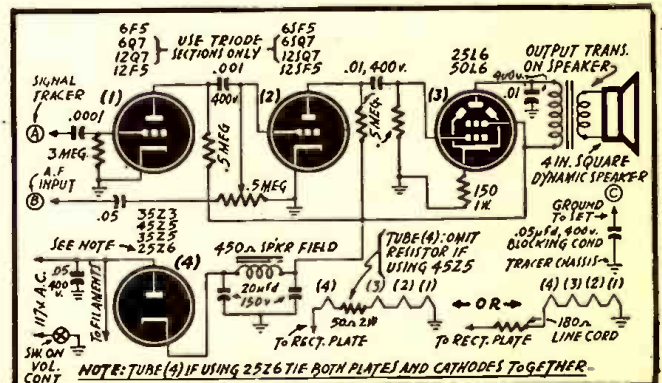



# RESULTS

of

# PHONO NEEDLE TESTS



The various forms into which different types of needles wear, as seen in micro-photographs.

**L**OW-PRICED "permanent" phono-graph needles are often better for your records than the high-priced ones, according to a preliminary survey made by Consumers Union of U. S. and announced in a recent issue of *Consumer Reports*. Of the permanent-type needles tested, those which showed the least wear on the needle tips generally caused the greatest record wear. On the other hand, the needle which caused the greatest record wear provided the listener with the best fidelity of tone.

The tests were conducted primarily to

show the relative wear on the records caused by different brands of needles; the relative merit of the different needles with respect to tone reproduction; and the number of records each needle can play without excessive wear on the records and without loss of tone quality. In evaluation of the needles, wear on records was weighted most heavily. Most of the needles tested gave satisfactory reproduction after 2000 playings. While the laboratory instruments indicated that losses could be expected in reproduction of the high frequencies, these high frequencies are scarcely,

if at all, audible on most home record players, and the loss should have little practical significance. More important was the finding that record wear increased after the needles had been played many hundreds of times. Considerable variation was found among different needles of the same brand; an occasional poor needle will be found even in the best brands.

Unfortunately the needle which gave the widest tone range was so damaging to the records as to be unacceptable for satisfactory use. Good fidelity of tone

would have to be accomplished in the treble boost circuits of the amplifier if any consideration is to be given to the care of the records. The survey states. "It should be realized that most records are not rich in high frequencies and that—as pointed out above—most reproducing systems in home radio-phonographs suppress the high frequencies even when they are present." However, the tone enthusiast usually has the best in pickups and amplifiers and speakers. A truly fine amplifier has what might be termed "reverse AVC," (the volume expander circuit).

With a speaker that can reproduce to about 7000 cycles and an amplifier that can give the necessary power without distortion from about 200 to 7000 cycles when taking its input from a good pickup, the one factor that remains to determine faithful reproduction is the needle. This can make a first-class amplifier sound third-rate, or make a poor amplifier sound somewhat better.

To convince yourself of the difference in needles, you can check them at home. Get a 10-inch record, either brand new or so little played that it shows no sign of wear when examined in a strong light. With the needle you want to check placed in the pickup arm, play a small portion of the record—say the outside half inch or inch—about 25 times. Then wipe off any dust on the record and hold it up to a strong direct light, examining it carefully from different angles. If the entire test area on the record looks definitely gray, then the needle will probably cause excessive wear, and you will be wise not to use it on records you value.

The amount of material removed from the record by the rag will also indicate the amount of needle wear. Since any needle, no matter how good, will remove some of the record material, this should be allowed for in the analysis. Where there are very loud passages of music the record will show wear in any case, so this can be discounted. A very bad needle will cause more or less uniform graying throughout the portion of the record tested, not only on loud passages.

The laboratory method of testing needles, as conducted by *Consumer Reports*, was slightly more complicated. First the needles were run in continuous circular grooves on special records made for the test. The increased noise level caused by wear was measured electrically. Then with one needle kept as a standard for comparison, five needles of each brand were tested simultaneously on five different record changers. The same ten-inch record was used for all tests. Since it was found that increased wear caused increased graying of the record surface as a result of minute abrasions and chipping, the wear caused by each needle was determined visually. Fidelity of reproduction was determined by electrical measurements with the use of special records giving standard tone frequencies ranging from the very low to the very high. The microscope was used to show the amount of needle wear.

The number of records a particular  
(Continued on page 143)

BRAND	TONAL REPRODUCTION	RECORD WEAR	LIST PRICE
FIDELITONE MASTER	POOR	LITTLE	\$1.50
FIDELITONE DELUXE	FAIR	LITTLE	\$1.00
FIDELITONE	FAIR	LITTLE	\$0.50
CONCERTONE 2500	SATISFACTORY	LITTLE	\$1.00
PFANSTIEHL	SATISFACTORY	SOME	\$1.50
WALCO GENUINE SAPPHIRE	GOOD	CONSIDERABLE	\$1.00
RECOTON SAPPHIRE	EXCELLENT	EXCESSIVE	\$6.00

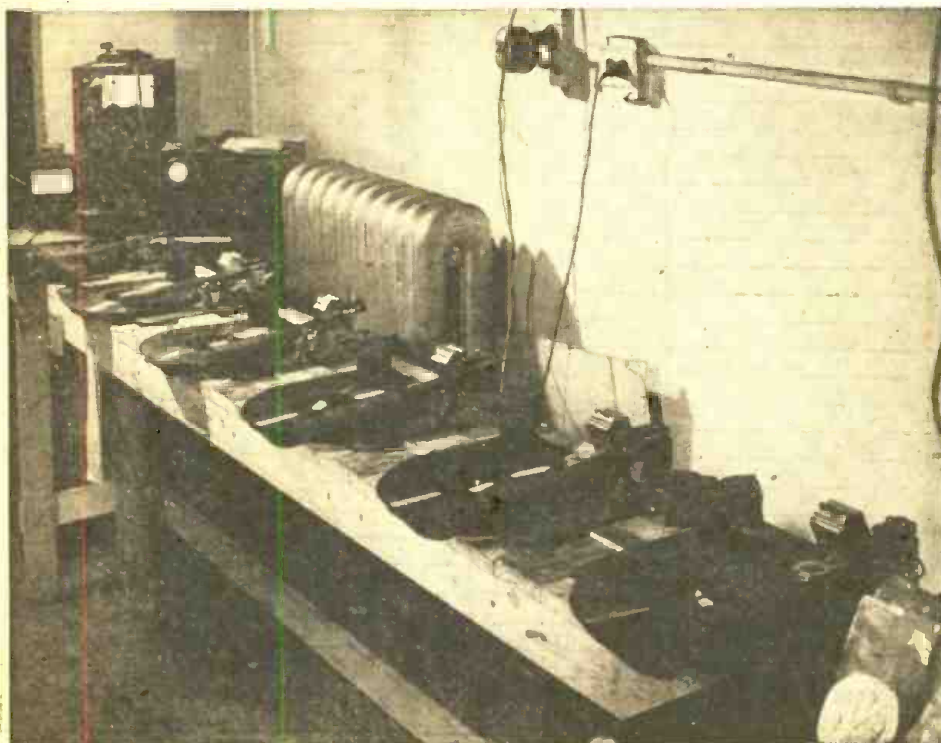

Photo Courtesy Consumer Reports

Laboratory setup for phonograph needle tests.

12SR7	6SR7		
	6ST7		
14A7	7A7	12SK7	6SK7
14B6	7B6	12SQ7	2A6



Suggested by:  
J. E. Dunnett,  
Vancouver, B.C., Canada

Quit asking 'em "What's cooking?"—and tell 'em to get us outta this stew.



# TUBE REPLACEMENTS

PART V—Tubes With Exactly Equivalent Electrical Characteristics

## New Radio-Electronic Devices

### ANTENNA TUNER

The Andrew Co.  
Chicago, Ill.

THE first and only instrument of its kind. Type 760 Andrew Antenna tuning unit is used for coupling a single antenna into a number of receivers, or a number of antennas into a single receiver.



Containing six RF amplifiers with an associated power supply, each amplifier stage in this unit has low impedance input and output circuits. These circuits may be series connected for use with a single antenna or receiver. This equipment is especially useful where antennas are remotely located from receivers, as in communications systems.—Radio-Craft

### TUBE EXTRACTOR

The BMP Company  
Boonton, N. J.

THIS new tube extractor finds application in the inserting and extracting of delicate miniature and straight-side glass radio receiver tubes, manufactured in the following standard bulb sizes:

Bulb Size	Tube Types
T5½	1A3, 6AG5, 9001, 1645 and 26 similar types.
T7	0Z4G, 921, 922, 926, 936, etc.
T8	1P9, 917, 8012, 1640, 868, etc.
T9	6E5, 7A4, 35A5, 1629, 50A5 and 140 similar types.

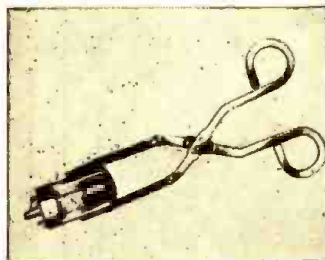

The gripping surface of this tube extractor is rubber-covered. The prongs are of a wide enough opening radius to fit all tube sizes. The construction of the extractor reduces breakage of thin tube walls, prevents burnt fingers and saves valuable time. The "puller" can be used in laboratories, test cage, production, inspection and/or servicing positions.—Radio-Craft

### DIELECTRIC HEATER

Radio Receptor Co.  
New York, N. Y.

THE Thermatron "HEAT-MASTER" is a compact model, particularly designed for heavy-duty preheating in the plastic molding industry where floor space is at a premium.

The unit incorporates a built-in electrode cage, automatic protection, heavy electrodes and new long-life radial-fin air cooled tubes. Other features include oversize casters for portability, safety interlocks, industrial type push buttons, overload relays and circuit breaker, connecting terminals, fully calibrated dials. Available accessories are foot control and continuous-belt heating oven.

The Radio Receptor "HEAT-MASTER" is capable of heating a 3.3 pound preform in one minute or a 5 pound preform in 90 seconds. Its generous capacity makes it suitable for rugged general purpose production as well as research requirements involving substantial power.—Radio-Craft

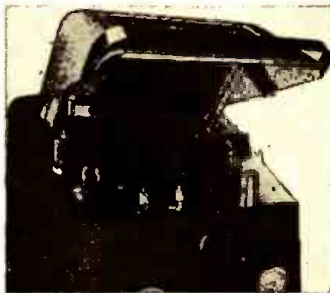

### PHONO PICKUP

Caltron Company  
Los Angeles, Calif.

AMONG the advantages claimed for this new high-fidelity pickup are a smooth response to 6,000 cps and a sharp cutoff beyond top frequency.

The unit has no bearings, pivots or needle chuck. It is stated the unit will track fully modulated pressings with 15 grams needle pressure.

It is extremely low in needle talk and eliminates all problems connected with temperature and humidity. Also, with this pickup, no scratch filter is needed in the amplifier.

The electrical circuit consists of two coils connected in series opposed. One of these coils is part of the generating system and the other acts as a hum-bucking coil. The combined impedance at the terminals is 100 ohms.

The output level at 1000 cycles is approximately 2.5 millivolts. This output is measured with a resistance termination of 1000 ohms. The pickup has a rising characteristic below 300 cycles and should be three to six db. at 50 cycles. Above 300 cycles it

is substantially flat to somewhat above 3000 and will have a somewhat broad peak between 4000 and 5000 cycles, after which the output drops rather sharply. Second and third harmonic distortion is well under 1%.—Radio-Craft

### STABILIZED RECTIFIERS

Green Electric Co.  
New York, N. Y.

GREEN Electric Company announces a further advance in the rectifier field—stabilized

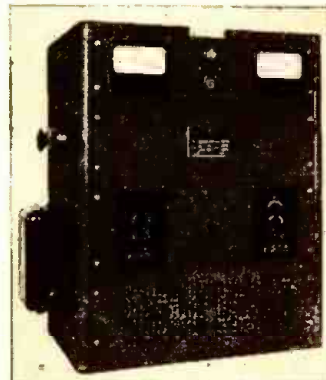

equipment with low voltage high current output.

The unit illustrated is rated at 200 amperes, voltage range zero to 3 volts. Any voltage selected in range is maintained to within 50 millivolts over load variation from zero to 200 amperes, and with line voltage variation of plus or minus ten per cent.

Voltage stabilization system includes motor-driven Powerstat and simple electronic pilot device. Principle is widely applicable to larger or smaller rectifier units.—Radio-Craft

### CRYSTAL UNIT

Bliley Electric Co.  
Erie, Penna.

THE FM6 is a new low frequency crystal unit that will maintain its frequency within



considerably narrower limits than were heretofore obtainable. In this unit a resonant pin assembly has been employed. The steel pins are mechanically resonant to the crystal frequency or some multiple of that frequency so that any damping effect of the clamping pins is negligible.

The internal assembly is well protected against moisture and humidity by means of a captive gasket seal employed between the aluminum shell and laminated phenolic base. Formerly, most crystals in the range 70 kc. to 400 kc. were either clamped between phenolic knife edges or placed in a fixed air-gap assembly which allowed the crystal to shift between its electrodes with the resulting shifts in crystal frequency. The FM6 is intended for such applications as frequency standards, timers, measuring equipment, frequency meters, carrier current and other applications where an accurate and dependable source of low frequency is required.—Radio-Craft

### BROAD-BAND FILTER

Tobe Deutschmann Corp.  
Canton, Mass.

DESIGNED for continuous operation at 500 volts D.C. or A.C. at a full load current of



100 amperes, the broad-band screen-room line filter is available for installation in two-wire and three-wire circuits. It is contained in a welded housing of 16 gauge steel with knock-outs at each end to accommodate two inch conduit; a removable cover is attached by four screws. Ample space is provided in each end of the housing to accommodate the slack in the connected leads. The three-wire filter is 23 inches long by 12 inches wide by 4½ inches deep; the two-wire filter is 20 inches long by 8 inches wide by 4½ inches deep. Electrical connection is made to ¾-inch threaded studs at opposite ends of the internal assembly. The frequency range and the voltage and current capacity of these line filters is ample for all present-day requirements in laboratory and production screen-rooms used in the testing and development of radio and other electronic products.—Radio-Craft



# RESULTS

of

# PHONO NEEDLE TESTS



The various forms into which different types of needles wear, as seen in micro-photographs.

**L**OW-PRICED "permanent" phono-graph needles are often better for your records than the high-priced ones, according to a preliminary survey made by Consumers Union of U. S. and announced in a recent issue of *Consumer Reports*. Of the permanent-type needles tested, those which showed the least wear on the needle tips generally caused the greatest record wear. On the other hand, the needle which caused the greatest record wear provided the listener with the best fidelity of tone.

The tests were conducted primarily to

show the relative wear on the records caused by different brands of needles; the relative merit of the different needles with respect to tone reproduction; and the number of records each needle can play without excessive wear on the records and without loss of tone quality. In evaluation of the needles, wear on records was weighted most heavily. Most of the needles tested gave satisfactory reproduction after 2000 playings. While the laboratory instruments indicated that losses could be expected in reproduction of the high frequencies, these high frequencies are scarcely,

if at all, audible on most home record players, and the loss should have little practical significance. More important was the finding that record wear increased after the needles had been played many hundreds of times. Considerable variation was found among different needles of the same brand; an occasional poor needle will be found even in the best brands.

Unfortunately the needle which gave the widest tone range was so damaging to the records as to be unacceptable for satisfactory use. Good fidelity of tone

would have to be accomplished in the treble boost circuits of the amplifier if any consideration is to be given to the care of the records. The survey states. "It should be realized that most records are not rich in high frequencies and that—as pointed out above—most reproducing systems in home radio-phonographs suppress the high frequencies even when they are present." However, the tone enthusiast usually has the best in pickups and amplifiers and speakers. A truly fine amplifier has what might be termed "reverse AVC," (the volume expander circuit).

With a speaker that can reproduce to about 7000 cycles and an amplifier that can give the necessary power without distortion from about 200 to 7000 cycles when taking its input from a good pickup, the one factor that remains to determine faithful reproduction is the needle. This can make a first-class amplifier sound third-rate, or make a poor amplifier sound somewhat better.

To convince yourself of the difference in needles, you can check them at home. Get a 10-inch record, either brand new or so little played that it shows no sign of wear when examined in a strong light. With the needle you want to check placed in the pickup arm, play a small portion of the record—say the outside half inch or inch—about 25 times. Then wipe off any dust on the record and hold it up to a strong direct light, examining it carefully from different angles. If the entire test area on the record looks definitely gray, then the needle will probably cause excessive wear, and you will be wise not to use it on records you value.

The amount of material removed from the record by the rag will also indicate the amount of needle wear. Since any needle, no matter how good, will remove some of the record material, this should be allowed for in the analysis. Where there are very loud passages of music the record will show wear in any case, so this can be discounted. A very bad needle will cause more or less uniform graying throughout the portion of the record tested, not only on loud passages.

The laboratory method of testing needles, as conducted by *Consumer Reports*, was slightly more complicated. First the needles were run in continuous circular grooves on special records made for the test. The increased noise level caused by wear was measured electrically. Then with one needle kept as a standard for comparison, five needles of each brand were tested simultaneously on five different record changers. The same ten-inch record was used for all tests. Since it was found that increased wear caused increased graying of the record surface as a result of minute abrasions and chipping, the wear caused by each needle was determined visually. Fidelity of reproduction was determined by electrical measurements with the use of special records giving standard tone frequencies ranging from the very low to the very high. The microscope was used to show the amount of needle wear.

The number of records a particular  
(Continued on page 143)

BRAND	TONAL REPRODUCTION	RECORD WEAR	LIST PRICE
FIDELITONE MASTER	POOR	LITTLE	\$1.50
FIDELITONE DELUXE	FAIR	LITTLE	\$1.00
FIDELITONE	FAIR	LITTLE	\$0.50
CONCERTONE 2500	SATISFACTORY	LITTLE	\$1.00
PFFANSTIEHL	SATISFACTORY	SOME	\$1.50
WALCO GENUINE SAPPHIRE	GOOD	CONSIDERABLE	\$1.00
RECOTON SAPPHIRE	EXCELLENT	EXCESSIVE	\$6.00

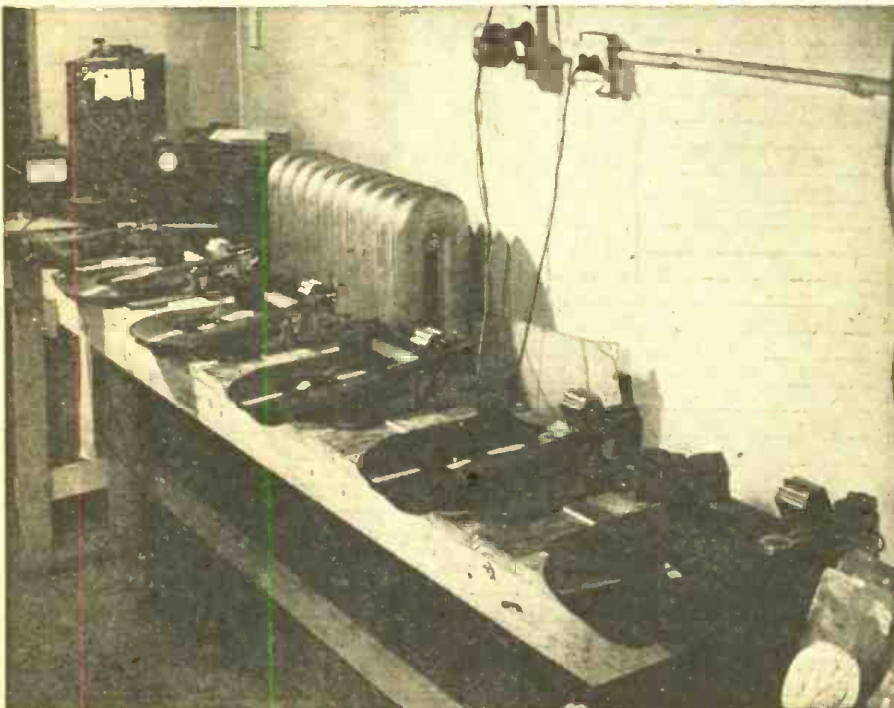

Photo Courtesy Consumer Reports

Laboratory setup for phonograph needle tests.



# TUBE REPLACEMENTS

## PART V—Tubes With Exactly Equivalent Electrical Characteristics

By I. QUEEN

**E**VERY tube type differs in some respect from every other type, otherwise they would have the same designation. These differences are often such that circuit modifications are necessary to accommodate substituted types. In many cases, however, the difference is merely one of socket or filament voltage only. Otherwise, the tubes may be electrically equivalent. A very small change of input capacitance (such as that due to metal tube construction as against glass) may be neglected.

A number of such equivalent tubes exist and should be known to the serviceman and technician, as it offers him an opportunity to exercise a choice depending upon convenience and availability. If it is known

that several tubes are equivalent except for socket or filament, choice would depend upon conditions, even though a particular tube is specified.

For example:

(a) The specified type may not be directly available as during a tube shortage.

(b) An equivalent type may be already on hand, making it unnecessary to obtain the specified type.

(c) Any type may be available for use, but the components on hand such as sockets and filament supply may favor one type against another.

The use of the same or an equivalent type is necessary in critical circuits, such as those involving industrial control, noise

limiting circuits, vacuum tube voltmeters and pushpull. Many VTVM circuits have been described in recent issues of *Radio-Craft*. In order to obtain the same results and calibrations, it is necessary for the reader to use the same tube or a corresponding type taken from the list, some of which he may already have from previous constructional articles.

An auxiliary list is also provided in this final article of the series. This includes the new type 1600 and 1800 tubes and their electrical equivalents in ordinary types. These new tubes are designed for special purposes such as low microphonics or noise, more uniform construction, etc. Otherwise they are equivalent to those listed.

Requires Change of:				Requires Change of:				Requires Change of:				
Orig. Type	Fil. Rating	Socket	Both	Orig. Type	Fil. Rating	Socket	Both	Orig. Type	Fil. Rating	Socket	Both	
1A4		1D5GT		3Q5GT/G		3LF4				4?	13	
ASGT/G		1LA4		5U4G		5X4G		6F7		6P7		
1A6		1D7G				5Z3		6F8G		6SN7	615*	
1B4		1E5G		5V4		83V					12SN7	
1B5		1H6G		5X4G		5U4G		6H6	12H6			
1C6		1C7G				5Z3		6J5	12J5	7A4	14A4	
1C7G		1C6		5Y3GT/G		5Y4G					6F8G*	
1D5GT		1A4				80					6SN7G*	
1D7G		1A6		5Y4G		5Y3GT/G					12SN7G*	
1D8GT			1LB4			80		6J7	12J7	6C5	57	
4E5G		1B4		5Z3		5U4G					6D7	
1E7G			1F4G†			5X4G		6K6			7B5	
			1F5G†		6A3		6B4				41	
1F4		1F5G	1E7G†		6A6	53	6N7		6K7	12K7	78	
1F5G		1F4	1E7G†		6A7	2A7	6A8	12A8	6K8	12K8		
1F6		1F7G					7B8	14B8	6N6		6B5	
1F7G		1F6		6A8	12A8	6A7	2A7		6N7		6A6	53
1H4G		30				7B8	14B8		6P5		76	55
1H5G		1LH4		6AD7†		6F6	2A5		6P7		6F7	
1H6G		1B5				42	18		6Q7	12Q7		
1J6G		19		6B4		6A3			6R7		7E6	
1LA4		1A5GT/G		6B5		6N6		6SA7	12SA7			
1LB4			1D8GT†	6B6		6SQ7	2A6	6SC7	12SC7			
1LH4		1H5GT/G				7B6	12SQ7	6SF5	12SF5	6F5	12F5	
2A5	18		6F6				14B6					7B4
	42		6AD7†				75	6SF7	12SF7			
2A6			6SQ7	6B7	2B7	6B8	12C8	6SG7	12SG7			
			7B6	6B8	12C8	6B7	2B7	6SH7	12SH7			
			6B6	6C6	57	6D7	12J7	6SJ7	12SJ7			
			12SQ7			6J7		6SK7	12SK7	7A7	14A7	
			14B6	6D6	58	6E7		6SL7	12SL7	7F7	14F7	
			75			6U7		6SN7	12SN7	6F8	6J5*	
2A7	6A7		6A8	6D7		6C6	57	6SQ7	12SQ7	6B6	14B5	
			7B8			6J7	12J7			7B6	2A5	
			14B8	6E5	2E5						75	
			12A8	6E7		6D6	58	6SR7	6ST7			
2B7	6B7		6B8			6U7			12SR7			
			12C8	6F5	12F5	7B4	12SF5	6ST7	6SR7			
2E5	6E5					6SF5			12SR7			
3LF4		3Q5GT/G		6F6		6AD7†	2A5					

(Continued on next page.)



Requires Change of:			
Orig. Type	Fil. Rating	Socket	Both
6U7		6D6	58
		6E7	
6V6		7C5	14C5
6V7		85	55
6Y6	25C6		
	50C6		
6Y7		79	
7A4	14A4	6J5	12J5
7A7	14A7	6SK7	12SK7
7B4		6F5	12F5
		6SF5	12SF5
7B5		6K6	
		41	
7B6	14E6	6B6	12SQ7
		6SQ7	2A6
		75	
7E8	14D8	6A7	2A7
		6A8	12A8
7C5	14C5	6V6	
7E6		6R7	
7E7	14E7		
7F7		6SL7	12SL7
7H7	14H7		
7J7	14J7		
7N7	14N7		
7Q7	14Q7		
7R7	14R7		
7S7	14S7		
7V7	14V7	7V7	14W7
7W7	14W7	7V7	14V7
7Y4	14Y4		
12A8	6A8		2A7
			6A7
			7B8
12C8	6C8		2B7
			6B7
12F5	6F5	12SF5	6SF5
			7B4
12H6	6H6		
12J5	6J5	14A4	7A4
12J7	6J7		57
			6C6
			6D7
12K7	6K7		78
12K8	6K8		
12Q7	6Q7		
12SA7	6SA7		
12SC7	6SC7		
12SF5	6SF5	12F5	6F3
			7B4
2SF7	6SF7		
12SG7	6SG7		
12SH7	6SH7		
12SJ7	6SJ7		
12SK7	6SK7	14A7	7A7
12SL7	6SL7	14F7	7F7
12SN7*	6SN7		6F8
			6J5
12SQ7	6SQ7	14B6	2A6
			6B6
			7B6
			75
12SR7	6SR7		
	6ST7		
14A7	7A7	12SK7	6SK7
14B6	7B6	12SQ7	2A6

Requires Change of:			
Orig. Type	Fil. Rating	Socket	Both
			6B6
			6SQ7
			75
14B8	7B8	12A8	2A7
			6A7
			6A8
			6V6
14C5	7C5		
14E7	7E7		
14H7	7H7		
14J7	7J7		
14N7	7N7		
14Q7	7Q7		
14R7	7R7		
14S7	7S7		
14V7	7V7	14W7	7W7
14Y4	7Y4		
18	2A5		6F6
	42		6AD7†
19		1J6	
25A6		43	
25B5		25N6	
25C6	50C6		
	6Y6		
25L6	50L6		
25N6		25B5	
25Z5		25Z6	50Y6
25Z5	50Y6	25Z5	
30		1H4	
35A5		35L6	
35L6		35A5	
35Z3		35Z4	
35Z4		35Z3	
35Z5	45Z5		
45Z5	35Z5		
41		6K6	
		7B5	
42	2A5	6F6	
	18		
43		25A6	
50C6	6Y6		
	25C6		
50L6	25L6		
50Y6	25Z6		25Z5
53	6A6		6N7

Requires Change of:			
Orig. Type	Fil. Rating	Socket	Both
55	85		6V7
56	76		6P5
57	6C6		6D7
			6J7
			12J7
58	6D6		6E7
			6U7
75		6B6	2A6
		7B5	12SQ7
		6SQ7	14B6
76	55	6P5	
78		6K7	12K7
79		6Y7	
80		5Y3G	
80		5Y4	
83V		5V4	
85	55	6V7	
117P7GT		117L/M7GT	
117L/M7GT		117P7GT	

One 1E7-G tube is equivalent to two 1FS-G or 1F4-G types

† refers to pentode unit only

\* Two 6J5 tubes equivalent to single 6SN7 or 6F8

**Auxiliary List of 1600 and 1800 Special Tubes**

Type	Same as	Special characteristics
1603	6C6	Low microphonics
1612	6L7	Low microphonics
1620	6J7	Low microphonics
1629	6E5*	12V @ .15A. filament
1631	6L6	12V @ .15A. Also more uniform characteristics
1632	25L6	12V @ .15A. Also more uniform characteristics
1634	12SC7	For critical matching of the two units
1644	12L8	For critical matching of the two units
1851	6AC7*	Different socket connections

\* Requires socket change

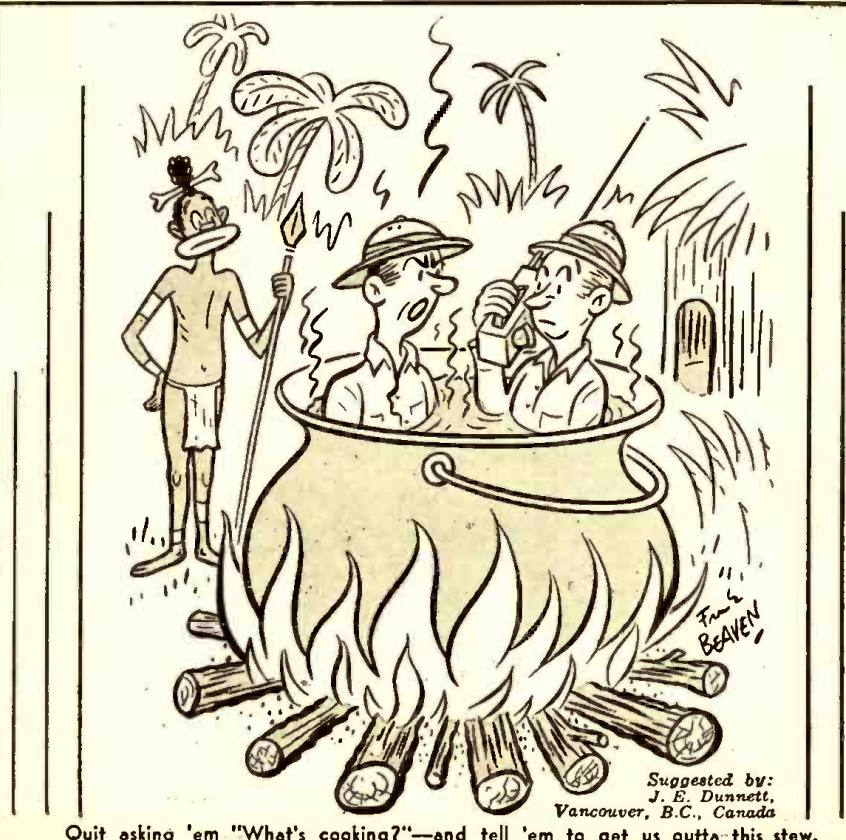

Suggested by:  
J. E. Dunnett,  
Vancouver, B.C., Canada

Quit asking 'em "What's cooking?"—and tell 'em to get us outta this stew.



# New Radio-Electronic Devices

## ANTENNA TUNER

The Andrew Co.  
Chicago, Ill.

THE first and only instrument of its kind. Type 760 Andrew Antenna tuning unit is used for coupling a single antenna into a number of receivers, or a number of antennas into a single receiver.



Containing six RF amplifiers with an associated power supply, each amplifier stage in this unit has low impedance input and output circuits. These circuits may be series connected for use with a single antenna or receiver. This equipment is especially useful where antennas are remotely located from receivers, as in communications systems.—Radio-Craft

## TUBE EXTRACTOR

The BMP Company  
Boonton, N. J.

THIS new tube extractor finds application in the inserting and extracting of delicate miniature and straight-side glass radio receiver tubes, manufactured in the following standard bulb sizes:

Bulb Size	Tube Types
T5½	1A3, 6AG5, 9001, 1645 and 26 similar types.
T7	0Z4G, 921, 922, 926, 936, etc.
T8	1P9, 917, 8012, 1640, 868, etc.
T9	6E5, 7A4, 35A5, 1629, 50A5 and 140 similar types.

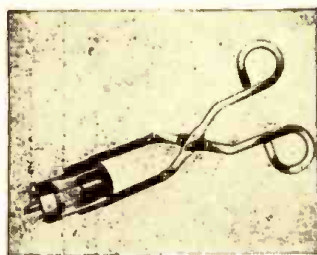

The gripping surface of this tube extractor is rubber-covered. The prongs are of a wide enough opening radius to fit all tube sizes. The construction of the extractor reduces breakage of thin tube walls, prevents burnt fingers and saves valuable time. The "puller" can be used in laboratories, test cage, production, inspection and/or servicing positions.—Radio-Craft

## DIELECTRIC HEATER

Radio Receptor Co.  
New York, N. Y.

THE Thermanon "HEAT-MASTER" is a compact model, particularly designed for heavy-duty preheating in the plastic molding industry where floor space is at a premium.

The unit incorporates a built-in electrode cage, automatic protection, heavy electrodes and new long-life radial-fin air cooled tubes. Other features include oversize casters for portability, safety interlocks, industrial type push buttons, overload relays and circuit breaker, connecting terminals, fully calibrated dials. Available accessories are foot control and continuous-belt heating oven.

The Radio Receptor "HEAT-MASTER" is capable of heating a 3.3 pound preform in one minute or a 5 pound preform in 90 seconds. Its generous capacity makes it suitable for rugged general purpose production as well as research requirements involving substantial power.—Radio-Craft



## PHONO PICKUP

Caltron Company  
Los Angeles, Calif.

AMONG the advantages claimed for this new high-fidelity pickup are a smooth response to 6,000 cps and a sharp cutoff beyond top frequency.

The unit has no bearings, pivots or needle chuck. It is stated the unit will track fully modulated pressings with 15 grams needle pressure.

It is extremely low in needle talk and eliminates all problems connected with temperature and humidity. Also, with this pickup, no scratch filter is needed in the amplifier.

The electrical circuit consists of two coils connected in series opposed. One of these coils is part of the generating system and the other acts as a hum-bucking coil. The combined impedance at the terminals is 100 ohms.

The output level at 1000 cycles is approximately 2.5 millivolts. This output is measured with a resistance termination of 1000 ohms. The pickup has a rising characteristic below 300 cycles and should be three to six db. at 50 cycles. Above 300 cycles it

is substantially flat to somewhat above 3000 and will have a somewhat broad peak between 4000 and 5000 cycles, after which the output drops rather sharply. Second and third harmonic distortion is well under 1%.—Radio-Craft

## STABILIZED RECTIFIERS

Green Electric Co.  
New York, N. Y.

GREEN Electric Company announces a further advance in the rectifier field—stabilized

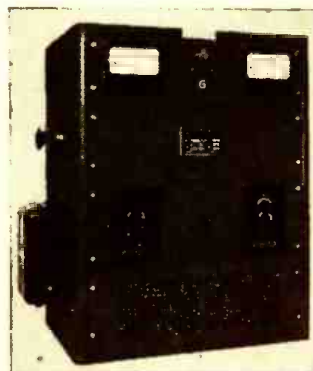

equipment with low voltage high current output.

The unit illustrated is rated at 200 amperes, voltage range zero to 3 volts. Any voltage selected in range is maintained to within 50 millivolts over load variation from zero to 200 amperes, and with line voltage variation of plus or minus ten per cent.

Voltage stabilization system includes motor-driven Powerstat and simple electronic pilot device. Principle is widely applicable to larger or smaller rectifier units.—Radio-Craft

## CRYSTAL UNIT

Bliley Electric Co.  
Erie, Penna.

THE FM6 is a new low frequency crystal unit that will maintain its frequency within

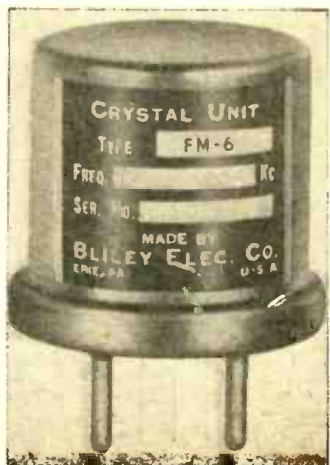

considerably narrower limits than were heretofore obtainable. In this unit a resonant pin assembly has been employed. The steel pins are mechanically resonant to the crystal frequency or some multiple of that frequency so that any damping effect of the clamping pins is negligible.

The internal assembly is well protected against moisture and humidity by means of a captive gasket seal employed between the aluminum shell and laminated phenolic base. Formerly, most crystals in the range 70 kc. to 400 kc. were either clamped between phenolic knife edges or placed in a fixed air-gap assembly which allowed the crystal to shift between its electrodes with the resulting shifts in crystal frequency. The FM6 is intended for such applications as frequency standards, timers, measuring equipment, frequency meters, carrier current and other applications where an accurate and dependable source of low frequency is required.—Radio-Craft

## BROAD-BAND FILTER

Tobe Deutschmann Corp.  
Canton, Mass.

DESIGNED for continuous operation at 500 volts D.C. or A.C. at a full load current of



100 amperes, the broad-band screen-room line filter is available for installation in two-wire and three-wire circuits. It is contained in a welded housing of 16 gauge steel with knock-outs at each end to accommodate two inch conduit; a removable cover is attached by four screws. Ample space is provided in each end of the housing to accommodate the slack in the connected leads. The three-wire filter is 23 inches long by 12 inches wide by 4½ inches deep; the two-wire filter is 20 inches long by 8 inches wide by 4½ inches deep. Electrical connection is made to ¾-inch threaded studs at opposite ends of the internal assembly. The frequency range and the voltage and current capacity of these line filters is ample for all present-day requirements in laboratory and production screen-rooms used in the testing and development of radio and other electronic products.—Radio-Craft



# CAPACITOR-RESISTORS

By ERNST GULKENHEIMER

**A**. C. voltage regulation has always been somewhat of a problem. In many cases, the use of a voltage dropping resistance has proven unsatisfactory for various reasons, chief among them being heat losses, need for adequate ventilation and size consideration. A satisfactory way of overcoming these difficulties is to reduce the voltage by means of a capacitor!

A capacitor (or condenser) is a device, that, when an alternating current source is applied to it will act practically as a resistor.

In direct current circuits, the power expended is given by the product of the applied voltage and the current. Thus, if an application of 110 volts to a circuit produces a current flow of 5 amperes, the power used is  $110 \times 5$  or 550 Watts.

In an A.C. circuit containing resistance only the voltage and current are in phase at all times, and the power still equals  $E \times I$ . When inductance or capacitance are applied to the circuit, the current then lags or leads respectively, the applied voltage. Therefore, the actual true power under these conditions is something less than  $E \times I$ . If the reactance is very great as compared to the resistance, the current is 90 degrees out of phase with the voltage and the actual or true power taken from the line is zero. This is commonly called "wattless current." In this type of circuit, the energy is stored in the form of an electrostatic field during one part of the cycle and is returned back to the line during the next part, so that the net power taken from the line is zero. When the current and voltage variations are not exactly 90 degrees out of phase, as is the case here in a capacitive circuit containing resistance, the power used is equal to the voltage across times the current through the resistive component of the circuit. Therefore, it is seen that, in the case of a capacitive circuit, the total useful or effective power supplied to the circuit is less than in the case of a similar circuit with pure resistance, and therefore, by choosing the proper capacity (at the proper voltage rating) you can have an efficient, trouble-free, cheap method of A.C. voltage regulation.

Now to simplify: Of course, condensers do not permit alternating currents to flow

through them with perfect ease. They impede A.C. just as a resistance does, and the term capacitive reactance is used to describe this effect in the case of condensers or capacitors. Capacitors have a reactance which is inversely proportional to the frequency of the applied voltage. The formula for capacitive reactance is

$$X_c = \frac{1}{2\pi f C} \dots \dots \dots (1)$$

where  $X_c$  is capacitive reactance in ohms  $\pi$  is 3.1416  
 $f$  is frequency in cycles  
 $C$  is the capacity of the condensers in FARADS.

Where the capacity is in microfarads (mfd.) as it is in most practical cases, the formula becomes

$$X_c = \frac{10^6}{2\pi f C(\text{mfd.})}$$

$10^6$  being 1,000,000

For example, let us say that we have a 2 mfd. condenser and we want to find its capacitive reactance at a frequency of 60 cycles. Substituting in the formula we now have

$$X_c = \frac{1,000,000}{2 \times 3.1416 \times 60 \times 2} = 1326 \text{ ohms}$$

Therefore it is seen that a 2 mfd. condenser will act as a theoretical resistance of 1326 ohms at 60 cycles.

However, in the run-of-the-mill circuit, there exist two factors; namely capacitive reactance and resistance. Therefore it is necessary to know how to combine these two in order to obtain the impedance which is also expressed in ohms. The formula for this is:

$$Z = \sqrt{R^2 + X^2} \text{ or } Z = \sqrt{R^2 + \left(\frac{1}{2\pi f C}\right)^2} \dots \dots (2)$$

After you have determined the voltage across the tubes, it is easy to determine the

drop across the capacitor by applying the formula  $X = \frac{V}{I}$  which is also expressed in ohms.

For example: If you have a radio set in which the tubes require 70 volts and the power supply source is 110 volts at 60 cycles, there is a difference of potential of 40 volts across the capacitor in question. If the total current is 150 Ma., by substituting in the formula we would now have  $X = 40/15$  or 266 ohms.

Now having obtained the resistance (this becomes the value for your reactance), refer to Fig. 1 and see that 266 ohms is approximately 10 mfd. Therefore, a 10-mfd. capacitor will act satisfactorily as a 266-ohm resistor at 60 cycles, 110 volts to take up a voltage drop for a series of tubes requiring 70 volts at 150 Ma.

Once  $C$  is known, the wattage can easily be calculated. However, this is worked out for you in Fig. 2. In the sample problem, the dotted lines show the same 10 mfd. capacitor handles 69.6 watts.

**DO NOT ATTEMPT TO USE AN ELECTROLYTIC CONDENSER.** The reason for that is that in cases of a reversal of polarity such as we have here, heat generated by the heavy current flowing through the capacitor would destroy the unit. This is due to the uni-directional property of the dielectric which retards the current flow in one direction but offers no resistance in the other one.

In addition to the use of capacitors for regulation of the tube voltage in a radio set, this neat little trick can be used for a host of other electronic control purposes. You can regulate the amount of voltage and consequently the amount of heat, of a soldering iron, for example, by computing the correct capacity required and connecting it in series with the iron. Or you can build a stand with a micro-switch actuated by the part of the stand that the iron tip rests on, or simply a plain toggle switch built into the iron stand can be used to switch the capacitor into and out of the circuit.

(Continued on page 123)

Fig. 1—Reactance vs. capacity. Fig. 2—A wattage table.

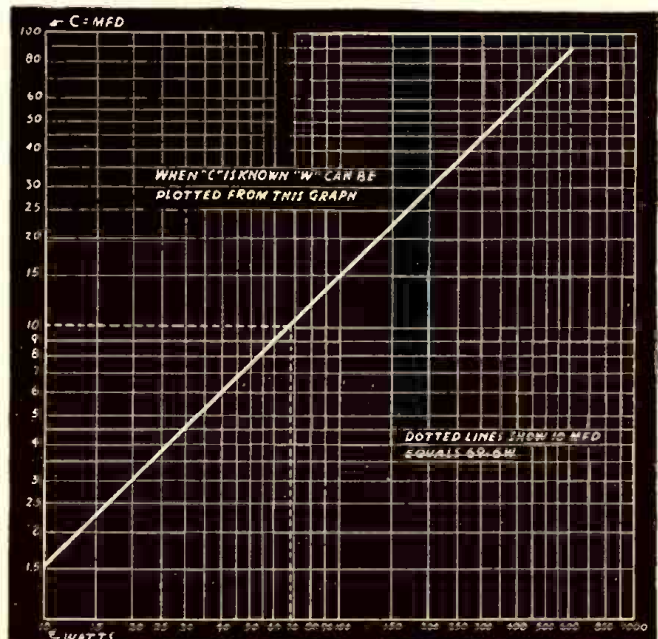



# World-Wide Station List

Edited by ELMER R. FULLER

**M**ANY changes in the short wave spectrum have been noted since V-J day; several new stations have appeared and many of the old-timers from pre-war days have returned to the air waves to add to the problem of kilocycle splitting. To add to the confusion of new and revised schedules; new and returned stations; we must make allowance for the return to Standard Time. With this issue, and we hope from now on, our schedules will be given in *Eastern Standard Time*. We hope that this will not

confuse you, when reading our schedules as published in past issues.

A report was received recently that a station in Addis Ababa, Ethiopia, is being heard 10:30 to 11:30 am on 4.965 megacycles. This report has been confirmed, and this station is heard on the east coast now and then at this hour. LRS1 in Buenos Aires, Argentina, is now using 5.985 megacycles and is heard from 5 to 11 pm. ZFY in Georgetown, British Guiana, is heard at 2:45 to 7:15 pm on 6.000 megacycles. Prague, Czechoslovakia, is using the call

OLR2A on 6.010 megacycles at 11 pm to 12:45 am.

Spanish Morocco is being heard occasionally at 3 to 4 pm on a frequency of 6.065 megacycles. As far as known, no call is used. VPD2 in the Fiji Islands is now being heard at 3 to 5 am on 6.130 megacycles; and makes a very good catch, with fair signal strength. By this time most of you have probably noted the stations now operating from Munich, Germany, at 11 pm to 2 am on 6.160 megacycles. This dope was received just too late for the last issue.

Bern, Switzerland, now uses 6.345 megacycles at 8:30 to 11 pm; 7.380 megacycles at 9:30 to 11 pm and 11 am to 1:30 pm; 9.185 megacycles at 9:30 to 11 pm and 15.875 megacycles at 3:15 to 3:50 pm. 6.345 and 9.185 megacycles are the best, as they are beamed to North America.

Wellington, New Zealand may now be heard at 4:25 to 4:45 am on 6.715 megacycles. The call is ZLT7, as in the past. Papeete, Tahiti is now using the call letters FO8AA and is broadcasting on Tuesdays and Fridays at 11 pm to midnight. The frequency in use at present is 6.980 megacycles.

Jerusalem, Palestine, is now on 7.220 megacycles and may be heard at 10:30 pm to 12:30 am and again at 2 to 3 am. The call used is JCKW. The Army Radio Service in Manila is heard daily at 5 to 8:15 am and 11 to 11:30 pm on 9.305 megacycles. An Austrian and a Bulgarian broadcaster have been reported; both near 9.350 megacycles; at various times during late afternoon and evenings. A Finnish station on 9.500 megacycles is being heard nightly at 7 to 7:30 pm; using the call OIX2. Japanese affairs are too uncertain to give a schedule of their transmissions. At the time of going to press, the best Jap station is on 15.325 megacycles and is being heard with good results on the east coast. The time is usually about 10:45 pm to 3 am.

This month we are presenting a graph of the most important and often heard stations during the evening hours of 6 pm until midnight. These are the hours at which the larger numbers of our readers have time to listen to short-wave radio. The X's indicate hours when the stations are on the air—blank spaces are silent periods. Time is given in 15-minute periods, as many of the stations run programs of this length. For data other than that given, please refer to previous issues of *Radio-Craft*. Remember that the time given is *Eastern Standard Time*. For the next three months, we will present to you a complete log of short wave stations arranged geographically by the country instead of the frequency.

Due to the fact that they are generally well known, U.S. stations were omitted from the graph of an "Evening of Listening."

Comments on this and future issues will be gratefully received. Address the editor, Elmer R. Fuller, c/o *Radio-Craft*, 25 West Broadway, New York City 7. Let us know what you want, and we will endeavor to get it in for you. Reports on post-war receivers (if you're lucky enough to have one) will be greatly appreciated. We are waiting for one here. Best of luck and lots of dx.

## "AN EVENING ON THE SHORT WAVES"

Frequency	Location	6	7	8	9	10	11	12 PM
2.500	Washington	X	X	X	X	X	X	X
3.400	Venezuela	X	X	X	X	X	X	X
3.460	Venezuela	X	X	X	X	X	X	X
4.700	British West Indies	X	X	X	X	X	X	X
4.785	Columbia	X	X	X	X	X	X	X
4.920	Venezuela	X	X	X	X	X	X	X
4.925	Columbia	X	X	X	X	X	X	X
4.945	Columbia	X	X	X	X	X	X	X
5.000	Washington	X	X	X	X	X	X	X
5.750	Surinam	X	X	X	X	X	X	X
5.875	Honduras	X	X	X	X	X	X	X
6.955	Haiti	X	X	X	X	X	X	X
5.970	Newfoundland	X	X	X	X	X	X	X
5.985	Argentina	X	X	X	X	X	X	X
6.000	British Guiana	X	X	X	X	X	X	X
6.000	Mexico	X	X	X	X	X	X	X
6.005	Canada	X	X	X	X	X	X	X
6.007	South Africa	X	X	X	X	X	X	X
6.070	Canada	X	X	X	X	X	X	X
6.110	England	X	X	X	X	X	X	X
6.130	Cuba	X	X	X	X	X	X	X
6.145	Columbia	X	X	X	X	X	X	X
6.150	England	X	X	X	X	X	X	X
6.190	India	X	X	X	X	X	X	X
6.205	Bolivia	X	X	X	X	X	X	X
6.220	Guatemala	X	X	X	X	X	X	X
6.345	Switzerland	X	X	X	X	X	X	X
6.465	Guatemala	X	X	X	X	X	X	X
6.980	Tahiti	X	X	X	X	X	X	X
7.190	Egypt	X	X	X	X	X	X	X
7.220	Palestine	X	X	X	X	X	X	X
7.250	Curacao	X	X	X	X	X	X	X
7.260	England	X	X	X	X	X	X	X
7.320	England	X	X	X	X	X	X	X
7.380	Switzerland	X	X	X	X	X	X	X
7.540	Guadeloupe	X	X	X	X	X	X	X
8.695	Cuba	X	X	X	X	X	X	X
8.905	Cuba	X	X	X	X	X	X	X
9.185	Switzerland	X	X	X	X	X	X	X
9.305	Philippines	X	X	X	X	X	X	X
9.350	Spain	X	X	X	X	X	X	X
9.370	Belgian Congo	X	X	X	X	X	X	X
9.500	Mexico	X	X	X	X	X	X	X
9.502	Finland	X	X	X	X	X	X	X
9.510	England	X	X	X	X	X	X	X
9.580	England	X	X	X	X	X	X	X
9.590	India	X	X	X	X	X	X	X
9.590	Netherlands	X	X	X	X	X	X	X
9.615	Costa Rica	X	X	X	X	X	X	X
9.630	Canada	X	X	X	X	X	X	X
9.640	England	X	X	X	X	X	X	X
9.720	Brazil	X	X	X	X	X	X	X
9.735	Portugal	X	X	X	X	X	X	X
9.763	Belgian Congo	X	X	X	X	X	X	X
9.825	England	X	X	X	X	X	X	X
10.000	Washington	X	X	X	X	X	X	X
10.130	Haiti	X	X	X	X	X	X	X
11.040	Portugal	X	X	X	X	X	X	X
11.616	Cuba	X	X	X	X	X	X	X
11.696	Panama	X	X	X	X	X	X	X
11.700	Brazil	X	X	X	X	X	X	X
11.705	Uruguay	X	X	X	X	X	X	X
11.720	Brazil	X	X	X	X	X	X	X
11.780	U. S. S. R.	X	X	X	X	X	X	X
11.780	Finland	X	X	X	X	X	X	X
11.845	France	X	X	X	X	X	X	X
11.970	Brazzaville	X	X	X	X	X	X	X
12.080	Brazil	X	X	X	X	X	X	X
12.110	Dominican Republic	X	X	X	X	X	X	X
12.250	Alaska	X	X	X	X	X	X	X
12.265	U. S. S. R.	X	X	X	X	X	X	X
12.445	Ecuador	X	X	X	X	X	X	X
15.000	Washington	X	X	X	X	X	X	X
15.225	Japan	X	X	X	X	X	X	X
15.230	Australia	X	X	X	X	X	X	X
15.250	Hawaii	X	X	X	X	X	X	X
15.310	England	X	X	X	X	X	X	X
15.315	Australia	X	X	X	X	X	X	X
15.325	Japan	X	X	X	X	X	X	X
15.505	Cuba	X	X	X	X	X	X	X
17.800	Hawaii	X	X	X	X	X	X	X



ing; and those who oppose all licensing.

In general, most radio and electronic servicemen proponents of compulsory licensing do not seem so much concerned about safety to life and property as about the "screwdriver-mechanic" — his competition, cut rates, poor impression given the public, and the many other claims about him. Others in favor of licensing believe that more uniform prices could be established; competition could be controlled; manufacturers and public would be benefited, the serviceman could be held responsible.

One example of this type of licensing is known to be in effect at present. Therefore, it may be interesting to many to present a brief outline of the essential points of the Madison, Wis., ordinance, enacted over four years ago, and entitled, "Licensing of Radio and Electronic Servicemen." Important portions are printed at the end of this article.

At the outset the ordinance stipulates no one shall do any servicing or installing of radio and electronic equipment unless he has first obtained a license. Provision is also made for apprentices. The term "radio and electronic equipment" includes any device using a vacuum tube having two or more elements for changing the form of electrical energy. The term also includes aeri-als and related devices.

Examinations are conducted twice a year by a Board of six members including: The city chief radio technician; the city electrical inspector; two appointed radio servicemen employers; and two appointed radio servicemen employees.

The ordinance specifies that the examination shall be both theoretical and practical with both oral and written questions and shall require a demonstration of skill through actual repairing.

If the applicant fails to pass the test, his \$10 examination fee is not returned but for that fee he will be allowed one more examination at the next examination period. If he passes, the fee forms his first year's payment. Annual renewals and apprentice fees are \$5.

Licenses may be revoked for the following reasons: (1) Habitual drunkenness or narcotics; (2) conviction of moral turpitude crime; (3) insanity; (4) fraud in

## LICENSING PROBLEMS

(Continued from page 90)

obtaining license; (5) for defrauding any person for whom he has rendered or has been requested to render service.

The electrical inspector has supervision over enforcement. If he judges there is a distinct hazard to life and property as set forth in the State Electrical Code (similar to National Electrical Code but with modifications) he may condemn or order such work repaired in a written notice to the owner of the equipment.

No license is requested for sales demonstrations, to test, remove, or install tubes; or by an owner to work on his own equipment.

Separate permits are required for loud-speaker, television, and multiple aerial installations, and extra license fees are required for sound cars and trucks. All are subject to inspection and approval by the electrical inspector.

Any violator of the ordinance (serviceman, owner, or other) is punishable by fine.

A study of the terms of the ordinance would indicate that every radio and electronic device with associated equipment is included.

### EFFECTS OF THE ORDINANCE

The specified method of examination seems fair and all inclusive, but some argument may arise as to its composition and administration. Servicemen comprise a majority of the Board. It is entirely possible for the members to be so minded to make the examinations sufficiently difficult (unusual problems, etc.) so that many or all would-be competitors could be eliminated. Reports from Madison indicate this condition does not prevail at present.

Although the electrical inspector has enforcement under his control it appears that only the owner of the equipment can be held responsible for correction of judged hazards.

As long as the serviceman does not defraud the customer, does not violate the other four previously mentioned reasons, and renews his license regularly there

seems to be no other reason for revocation of license and only competition would be the serviceman's real incentive to keep abreast of progress.

Although only a relatively small percentage of replies have been received from inquiries sent to Madison servicemen, dealers, and wholesalers, comments received thus far have been generally favorable to their licensing system. Concern was expressed over the soldier working out of his home, apparently unlicensed (Madison has Armed Forces training facilities nearby) but it was believed this condition would correct itself after the war.

Some opinions from Madison tend to be more critical of their ordinance and its method of operation.

One serviceman stated that licensing is not accomplishing much real benefit to the servicemen or public because little or no control is exercised over the quality of the serviceman's work. The public patronizes those servicemen doing the best work at reasonable prices.

(It is to be noted here that the ordinance does not provide for control over quality of workmanship. It is believed this would be extremely difficult to control as personal opinions vary widely on the many factors involved and the weight to be placed on each. Where is the line to be drawn on such factors as testing, cleaning, soldering, touching up cabinets, etc.?)

Another interesting point brought to light concerns those Madison dealers who buy up radio and electronic equipment for purposes of servicing and selling it. Under such conditions the ordinance in no way controls their activities whether desirable or otherwise. Owners are not prohibited from working on their own equipment or selling it.

Mention was also made that the licensing system was new and could be improved as time goes on, but it is claimed to have already eliminated a lot of out of town fly-by-night companies dealing in inferior communication equipment and service. It has also tended to eliminate servicing by unqualified personnel. General public opinion is not known to have been weighed on the merits of licensing.

(Continued on page 120)

## UNITED STATES FM BROADCAST STATIONS ON NEW FREQUENCIES

THE new frequencies for existing FM broadcast stations and those for which construction permits are outstanding have recently been announced by the FCC. The latest information available on the new assignments is given below:

### Metropolitan Stations

City	Call Letters	Channel Number	Radiated Power	Antenna Height	Frequency
Baton Rouge, La.	WBRL	41	20 kw	500	96.1
Binghampton	WNBF-FM	44	10.5 kw	657	96.7
Boston	WBZ-FM	39	20 kw	455*	95.7
Chicago	WBBM-FM	57	10 kw†	668	99.3
Chicago	WDLM	59	20 kw†	479*	99.7
Chicago	WELM	61	12 kw†	616	100.1
Chicago	WEHS	55	20 kw†	472*	98.9
Chicago	WWRZ	55	12 kw†	611	98.5
Columbus	WELD	33	20 kw	341*	94.5
Detroit	WENA	45	10.5 kw	663	96.9
Detroit	WLOU	43	20 kw	362*	96.5
Evansville	WMLL	34	20 kw	281*	94.7
Fort Wayne	WOWO-FM	40	20 kw	300*	95.9
Hartford	WTIC-FM	32	7.0 kw	758	94.3
Hartford	WABC-FM	28	9.5 kw	673	93.5
Indianapolis	WABW	35	20 kw	290*	94.9
Kansas City	KOZY	60	20 kw	500	99.9
Kansas City	KMBC-FM	50	20 kw	500	97.9
Milwaukee	WMFM	22	20 kw	310*	92.3
Nashville	WSM-FM	61	8.5 kw†	720	100.1
Philadelphia	KYW-FM	26	20 kw	382*	93.1
Philadelphia	WCAU-FM	38	20 kw	366*	95.5
Philadelphia	WFIL-FM	32	20 kw	464*	94.3
Philadelphia	WIP-FM	30	18 kw	520	93.9
Philadelphia	WBG-FM	36	20 kw	358*	95.1
Philadelphia	WPEF-FM	40	20 kw	455*	95.9
Pittsburgh	KDKA-FM	31	6.5 kw	783	94.1
Pittsburgh	WTNT	33	20 kw	500	94.5
Rochester	WHEF	53	20 kw	387*	98.5

City	Call Letters	Channel Number	Radiated Power	Antenna Height	Frequency
Rochester	WHFM	55	20 kw	261*	98.9
Salt Lake City	KSL-FM	61	8.5 kw	720	100.1
Schenectady	WGFM	37	6 kw	805	95.3
Schenectady	WBCA	39	6 kw	805	95.7
South Bend	WSBF	67	20 kw	312*	101.3
Springfield, Mass.	WBZA-FM	56	20 kw	500	99.1
Superior, Wisc.	WDUL	22	20 kw	500	92.3
Worcester, Mass.	WTAG-FM	71	20 kw	477*	102.1
Worcester, Mass.	WGTR	69	9.5 kw	680	101.7
Alpine, N. J.	WFMN	65	6.0 kw	795	100.9
New York, N. Y.	WOXO	63	11.5 kw	632	100.5
New York, N. Y.	WABF	53	15 kw	567	98.5
New York, N. Y.	WGYN	61	4.0 kw	905	100.1
New York, N. Y.	WFGG	59	7.2 kw	747	99.7
New York, N. Y.	WHNF	57	20 kw	455*	99.3
New York, N. Y.	WNYC-FM	51	15 kw	560	98.1
New York, N. Y.	WBAM	45	15 kw	559	96.9
New York, N. Y.	WABC-FM	47	5 kw	850	97.3
New York, N. Y.	WEAF-FM	49	1.6 kw	1258	97.7
Jersey City, N. J.	WAAW	41	13.5 kw	590	96.1

### Rural Stations

Located at present sites					
Mt. Washington, N. H.	WMTW	50	10 kw		97.9
Winston-Salem, N. C.	WMIT	47	200 kw		97.3

The following metropolitan stations may operate from their present sites with the power indicated below until such time as the Commission considers all of the applications in the Los Angeles area.

Los Angeles, Calif.	KHJ-FM	59	4.8 kw†	870	99.7
Los Angeles, Calif.	KTLO	61	4.8 kw†	870	100.1

\* This antenna height is based upon previously authorized antenna construction, and a minimum antenna height of 500 feet above average elevation will be required in the future unless a showing is made to the contrary that such an antenna height is not feasible.

† These stations in Area II have been assigned power less than presently authorized. The question of operating with higher power is now under study.



# An FM Phono Pickup

By NATHANIEL RHITA

**C**ONSTRUCTION details of an FM pickup whose output could be received directly on an FM receiver were given in the 1944 Reference Annual. It was shown that such a device makes possible better fidelity than conventional phono pickups.

More improvements have been made in this field, the latest being a push-pull phono pickup recently disclosed by Alexis Badmaieff and assigned to RCA\*. Not only does this instrument completely cover the

\*Patent No. 2,871,373

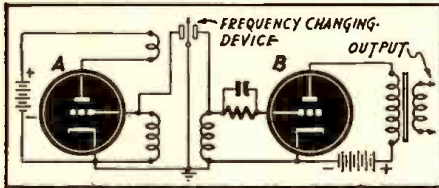
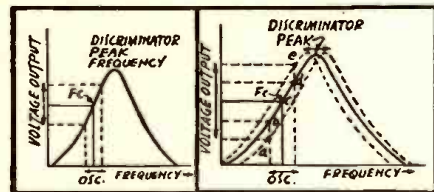

Fig. 1—Basic circuit of the new FM pickup.



Figs. 2 and 3—How modulation takes place.

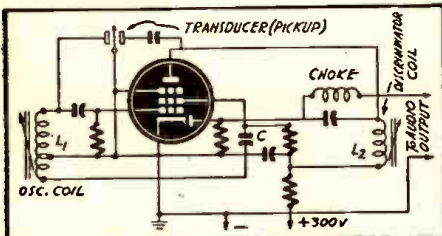

Fig. 4—A simple one-tube pickup circuit.

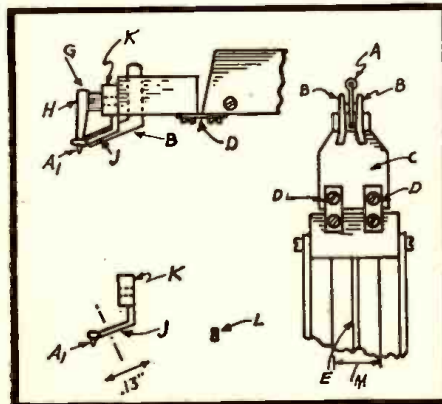

Fig. 5—Mechanical features of the design.

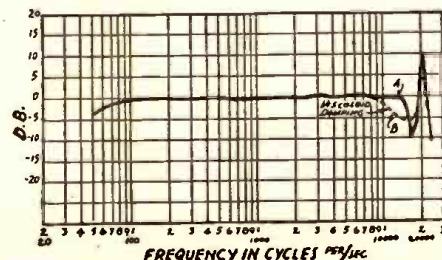

Fig. 6—The frequency response curve is flat.

audio range and far beyond, but its output is much higher. The wear on the record is practically negligible, and it includes a safety device which prevents needle damage should it be accidentally dropped on a record.

The basic hookup is given in Fig. 1. Tube A is a high-frequency oscillator. B is a discriminator tube whose peak frequency is displaced somewhat as shown in Fig. 2. The oscillator frequency  $F_c$  is adjusted to the steep portion of the discriminator's frequency characteristic. The pickup is shown as a dual capacitance, the stylus being grounded. Vibration of the latter in response to a recording causes it to alternately increase and decrease the frequency of the oscillator and discriminator in opposite phase.

The result is explained in Fig. 3. When the stylus moves to the left it decreases the oscillator frequency and simultaneously increases the discriminator resonant frequency. The first changes the operating point from c to b, while the second shifts the entire discriminator curve to the right, therefore fixing the operating point at a. Likewise, when the stylus moves to the right, the operating point will be found at c.

Not only is the output doubled as a result of this double change, but the push-pull effect also cancels out even-harmonic distortion which might otherwise occur.

A still more simplified circuit is that of Fig. 4, where only a single tube of the 6SF7 or similar type may be used.  $L_1$  is a tapped oscillator coil for the tube, which is electron-coupled.  $L_2$  is the discriminator coil. The output of the latter is applied to a diode plate through a fixed condenser. It is rectified, filtered and applied to an audio amplifier. The tube suppressor is used as an electrostatic shield.

Typical design of such an instrument may follow Fig. 5, where several views are shown. The sapphire stylus is mounted at the end of a steel wire bent as shown and mounted on a brass block. The side view shows only one fixed plate, but of course there are two, one on each side of the steel wire and mounted on a bakelite block. The use of a viscoloid strip between the stylus and mounting screws was necessary to suppress resonance in the stylus support wire.

The pickup head is connected to the main tone arm by means of two spring plates which permit mounting in the proper vertical direction and also prevent damage to the unit should it be dropped on a record. Two transmission lines, one from each fixed plate, are placed in channels in the tone arm which is mounted directly on the chassis of the circuit by means of the usual pivot.

By way of illustration, several dimensions of the parts are given. With a device of this general construction an unusually good frequency curve was obtained.

This FM circuit is not limited to record pickups. It may be used for cutting records or as a push-pull condenser microphone. Since it operates on a principle of small displacements, it can likewise find application in measuring vibration, pressure, etc.

### Design and Performance Data

Oscillator coil	7 turns tapped at 2
Oscillator frequency	between 30 and 60 Mc.
Discriminator coil	5 turns
Frequency deviation	120 Kc.
Stylus pressure	.33 ounce
Hiss output	7 Db. below ordinary pickups
Resonant frequency	21,000 cycles

## HOW TO TEST A RADIO IN 2 MINUTES OR LESS!

Want to repair radios for neighbors and friends? Or, if you are a radio serviceman, do you want to learn how to diagnose radio troubles and fix sets TWICE AS FAST and TWICE AS PROFITABLY—without a lot of costly, hard-to-get test equipment?

Of course you do—and Ghirardi's RADIO TROUBLE-SHOOTER'S HANDBOOK is just the book that will make it possible for you to do it—for a total cost of only \$5. Send coupon on opposite page today.

## HOW MUCH Should Good Radio-Electronic Training Cost?

The answer is that the best basic Radio-Electronic Training that money can buy NEED NOT COST YOU MORE THAN \$5 complete. Ghirardi's RADIO PHYSICS COURSE BOOK (see advertisement on opposite page) is as complete as any book or course AT ANY PRICE—and far more complete than most. It is much easier to learn from—and it is the basic training most widely endorsed by radio experts themselves. Money-back Guarantee. You cannot lose! Send coupon TODAY!

## TELEVISION PROGRAMMING & PRODUCTION

JUST OUT!



What kind of programs will Television have? How will they be prepared and handled? What are the technical difficulties involved and how can they be overcome? How and where can YOU fit into this fascinating work as Television steps into full-fledged growth? This new book by Richard Hubbell, an "old timer" at the game gives you the answers!

## TELEVISION IS COMING — FAST!

Television Programming and Production not only acquaints you fully with the most advanced techniques, but discusses technical problems and their relation to program handling, and includes a wealth of other material invaluable to all who want to participate in Television's coming of age. Contains 207 pages and more than 50 selected photos illustrating all program production phases. \$3 (\$3.25 foreign).



# WE'LL "LEND" YOU ANY OF THESE 3 GREAT BOOKS *for* 5 FULL DAYS

Every Cent of Your Money Cheerfully Refunded  
if You're Not More Than Satisfied



**ONLY \$5  
EACH**

The most and best Training for your money—You be the judge!

Get a better job—start a business of your own in fascinating Radio-Electronics!

## LEARN PROFESSIONAL SERVICING WORK at home

A. A. Ghirardi's big, 1,800-page MODERN RADIO SERVICING is the finest, most complete instruction course on Radio-Electronic service work for either the novice or professional serviceman—bar none! Ask anyone in the business! Read from the beginning, it is a COMPLETE COURSE IN SERVICING by the most modern methods. Used for reference, it is an invaluable means of brushing up on any servicing problems that puzzle you.

### EVERYTHING ABOUT TEST INSTRUMENTS, TROUBLESHOOTING, REPAIR

Gives complete information on all types of test instruments; how they work (with wiring diagrams); When, How and Why to use them; how to build your own; preliminary trouble checks; circuits and parts analysis; parts repair, replacement, substitution; obscure troubles; aligning and neutralizing—and hundreds of other subjects including How to Start Your Own Successful Radio-Electronic Service Business. 706 self-testing review questions help you check your progress every step of the way. 706 illustrations and diagrams. \$5 complete (\$5.50 foreign). 5-DAY MONEY-BACK GUARANTEE. See our Money-Saving Combination Offer in coupon.

## ALL THE SCIENCE OF BASIC RADIO-ELECTRONICS in one big 3½ lb. Book

For Beginners—36 Courses in One

Here is the big book that makes it easy for beginners to start in the fascinating field of Radio-Electronics! Actually, A. A. Ghirardi's 972-page RADIO PHYSICS COURSE book gives you just the basic training you need—ALL YOU NEED—easier, better, faster—for ONLY \$5 COMPLETE. Actually, this giant book is 36 courses in one. If sold in monthly lessons, you'd regard it as a BARGAIN AT \$50 OR MORE!

You'll be surprised how easily RADIO PHYSICS COURSE helps you master subjects that other courses make seem very complicated.

You'll be delighted how soon it will have you doing experiments, building equipment, etc. Step by step it carries you from the very beginning through Basic Electricity to the most modern Radio-Electronic developments. Hundreds of readers have completed it in a few weeks. All you need is a little reading time plus a desire to get started now for a better paying future in broadcasting, aviation radio, F-M, Television, radio servicing, manufacturing—or other fast-growing Radio-Electronic branches. 5-DAY UNRESERVED MONEY-BACK GUARANTEE!

Radio's Greatest Training Buy!

## THIS AUTOMATIC TEACHER SHOWS EXACTLY HOW TO REPAIR OVER 4,800 DIFFERENT MODELS!

Ghirardi's big RADIO TROUBLESHOOTER'S HANDBOOK is the ideal manual to show you exactly how to repair radios quickly, without a lot of previous experience and without costly equipment. This 744-page manual-size HANDBOOK brings you specific repair data for the common faults that account for almost 90% of ALL troubles in practically every radio in use today! You don't study it. Simply look up the make, model, and trouble symptom of the Radio you want to repair. No lost time! Clear instructions tell you exactly what the trouble is likely to be, exactly how to fix it.

Specific instructions cover over 4,800 of the most popular models of Home and Auto-radio receivers and Automatic Radio Changers of 202 manufacturers!

Also, RADIO TROUBLESHOOTER'S HANDBOOK has hundreds of additional pages of repair charts, tube charts, data on tuning alignment, transformer troubles, tube and parts substitution, etc., etc., all designed to help you repair all makes and models of radios, faster, and more profitably! Only \$5 (\$5.50 foreign). FIVE DAY UNRESERVED MONEY-BACK GUARANTEE!

Make Money in Your Spare Time!

## 5-DAY MONEY-BACK GUARANTEE

Technical Division, MURRAY HILL BOOKS, INC.  
Dept. RC-115, 232 Madison Ave., New York 16, N. Y.

Enclosed find \$..... for books checked; or  send C.O.D. (in U.S.A. only) for this amount plus postage. If not fully satisfied, I may return the books within 5 days and receive my money back.

- RADIO PHYSICS COURSE. \$5 (\$5.50 foreign).  RADIO TROUBLESHOOTER'S HANDBOOK. \$5 (\$5.50 foreign).  
 TELEVISION PROGRAMMING & PRODUCTION (see advertisement on opposite page). \$3 (\$3.25 foreign).  MODERN RADIO SERVICING. \$5 (\$5.50 foreign).  
MONEY-SAVING COMBINATION: MODERN RADIO SERVICING and RADIO TROUBLESHOOTER'S HANDBOOK (both books) only \$9.50 (\$10.50 foreign).

Name .....  
Address .....  
City & Dist. No. .... State .....

# TRAIN NOW FOR THE BEST OF ALL POSTWAR INDUSTRIES



# Radio-Electronic Circuits

## V.T.V.M.

Figure 1

This one-tube electron voltmeter was built to use a zero-center 1 Ma. meter and a 6F8 tube I had on hand. It is a very effective little instrument and uses only one manual control, for the zero adjustment.

To adjust the 2-volt scale increase or decrease the ohmage of  $R_1$  until the correct reading is obtained. Then the other scales will be correct automatically.

Do not use any A.C.-D.C. power supply or any power transformer in which the line can be grounded to the chassis of the V.T.V.M. The one used in my instrument was a tube tester transformer, which isolates the line. One 6F8 works both as the triode for the tester and as a diode for the power supply.

The best way to calibrate the set for the 2-volt scale is to get a D.C. voltmeter and supply a measured voltage of 2 volts to the input by using a voltage divider across two dry cells or low-voltage D.C. power pack.

W. FRED WHALEN,  
Ottawa, Canada

## PRE-TUNED SET

Figure 2

A short time ago, my companions and myself decided to build a simple radio for our entertainment during these long Hawaiian days. We wanted to use a switch in place of the conventional tuning capacitor, since there are only two broadcast stations in the vicinity, and the idea of pre-set capacitors rather intrigued us.

Since we desired high-fidelity operation (for one of the stations modulates up to 7,000

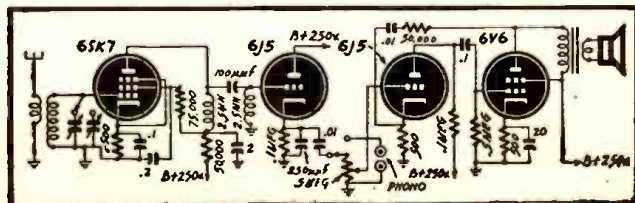
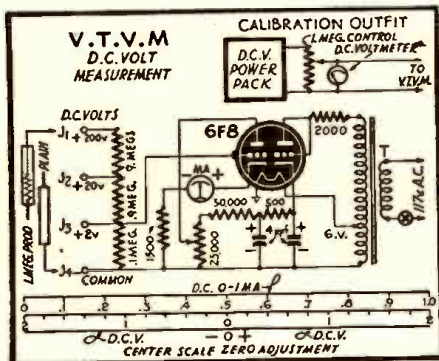

Radio-Craft welcomes new and original radio or electronic circuits. Hook-ups which show no advance on or advantages over previously published circuits are not interesting to us. Send in your latest hook-ups—Radio-Craft will extend a one-year subscription for each one accepted. Pencil diagrams—with short descriptions of the circuit—will be acceptable, but must be clearly drawn on a good-sized sheet of paper.

cycles), we used an impedance-loaded R.F. amplifier rather than another tuned circuit. The high-quality infinite-impedance detector does not overload and gives distortion-free response.

This detector is coupled through a phono-radio switch into a two-stage audio amplifier. An inverse-feedback network is incorporated to enhance the bass response and to reduce second-harmonic distortion. The power supply is a conventional full-wave rectifier and capacitor input filter.

AT 2/c JEROME I.  
COOPERMAN,  
San Francisco, Calif.

## WIRELESS PHONO OSCILLATOR

Figure 3

This wireless phono oscillator uses a minimum of parts and is very simple to build. It can be used with a high- or low-impedance crystal or magnetic pick-up or as a home broadcaster with a crystal or dynamic microphone.

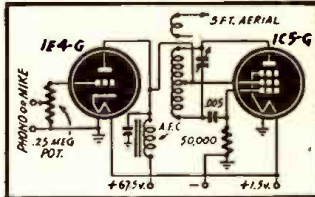

Figure 3

The coil may be any broadcast-band, center-tapped antenna coil. When used in conjunction

To use this oscillator, tune your radio to a spot where no stations are heard. Have the receiver's volume control set at a point used for the reception of local stations. Attach a phonograph to the oscillator and place a record on the turntable. Increase the volume on the oscillator and tune the variable condenser until the signal is heard in the receiver.

This wireless phono oscillator will work more than satisfactorily up to 50 feet with a 67½-volt B battery.

BERNARD ENGLISON,  
Brooklyn, N. Y.

## HIGH FIDELITY TUNER

Figure 4

A simple TRF tuner for local broadcast reception capable of reproducing a wide band of frequencies, 20 cycles to 10 Kc, can be built from parts easily obtained from any old TRF receiver. An infinite impedance detector is used on account of its low harmonic distortion capabilities. Resistors are used in shunt with the tuned circuits for wide band passage, and should not be less than 50,000 ohms as adjacent channel interference may be encountered.  $C_2$  is used in the cathode of the 27 cathode follower stage, as a bypass condenser, increasing the high frequency output. The antenna should be as short as possible for best results.  $L_1$  and  $L_2$  are broadcast TRF matched coils and  $C_1$  and  $C_3$  is a 2-gang variable tuning condenser.

When used in conjunction

with a high-fidelity amplifier, excellent results are obtained.

ROBERT H. KNAPP,  
Covington, Kentucky

(For use in areas near a number of powerful transmitters, probably another stage of R.F. would be required for sufficient selectivity, as the resistance-shunted coils tune broadly.—Editor)

## BROADCAST 30 SET

Figure 5

This set gives good results on local stations with 3 volts on the plate. At this location, a

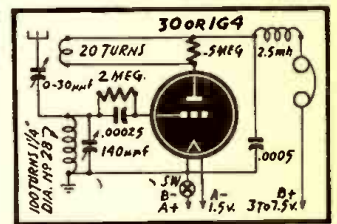

Figure 5

half-dozen broadcast stations were tuned in clearly, at a distance of about 25 miles. The values of the parts are not critical, and even the regenerative action of the tickler coil needn't be used.

I started out with a 100,000-ohm volume control across the tickler, but took off turns and put in the half-megohm fixed resistor after a number of experiments. If the experimenter wants regeneration, a 50,000 or 100,000-ohm variable can be used, with tickler turns adjusted till the set breaks into oscillation with most of the resistance in circuit.

BILL BUEHRLE, JR.  
Ferguson, Mo.

(To cover the whole broadcast band with a 140-mmf condenser two coils may be needed.—Editor)



PRACTICAL  
HOME-STUDY

# RADIO COURSE

## AMAZING BARGAIN OFFER

IN MANUAL FORM

\$2.50  
COMPLETE

**SPECIAL OFFER**  
READ THE DETAILS

**These men used this course to get into good radio jobs**



### FINEST TRAINING COURSE USED IN MANY SCHOOLS

"The radio training course is the finest up to date easy to understand course. . . . This course outlines practical work. We are using this course in our Topeka High School. It is wonderful." *Henry Ward, Jr., 622 Filmore St., Topeka, Kans.*



### WORTH MUCH MORE

"You should get more money for your Course. The first week I studied it. I made \$10.00 repairing sets. I built my own test outfit from details given in this course. I have repaired 100 radios to date. Signed: *Robert C. Hammel, 120 W. 13th, Davenport, Iowa.*



### COMPLETED IN 8 WEEKS

"I am very satisfied with the course. When I was at the twelfth lesson I started repairing radios. It took me two months to master your course." From a letter written by *Roger Lanzetta, 1679 Poupart, Montreal, Canada.*



### MODERN, UP-TO-DATE

"I have found since taking your course how modern and up to date it really is. There is not one page in the whole course which anyone interested in radio can afford to miss. Your course started me on the road to a well paid job and has repaid me many times." *Charles Alapach, 433 Elm St., Reading, Pa.*

Greatest value in radio training. In this large course manual of 22 practical lessons, you have all the topics covered by the best \$100.00 radio correspondence course. Review important fundamentals; learn advance technique. Speed-up radio servicing. Includes hundreds of circuits, thousands of repair hints, many servicing short-cuts, ideas, and simplified tests.

## IMPROVE YOUR RADIO KNOWLEDGE

This practical home-study course will show you how to repair all types of sets faster and better, tell you how to open your own shop and run the business. The lessons are well illustrated, interesting to read, easy to understand and apply. No special previous knowledge is needed. The early lessons explain important principles. Other lessons cover test equipment, troubleshooting, circuit tracing, television, and every other important topic of radio servicing.

### SERVICING SIMPLIFIED

Learn new speed-tricks for radio fault-finding, case histories, servicing short-cuts, extra profit ideas. Included are many large lessons on the use of regular test equipment, explanation of signal tracing, oscilloscope, transmitters, P.A., television, recorders. Let this information save for you enough time on a single job to pay the full price of \$2.50 for the complete course of 22 money-making lessons.

### LESSONS ON ALL TOPICS

The practical lessons making up this course-book are easy to follow and apply to actual radio jobs. Hundreds of radio facts that puzzled you will be quickly cleared up. You will find yourself doing radio repairs in minutes instead of hours—quickly finding the faults or making needed adjustments. Every new radio development of importance and thousands of time-saving radio facts are packed into this complete course-manual. New edition, reprinted in 1945.



Edited by  
M. N. Beitman;  
radio engineer,  
teacher, author,  
& serviceman.

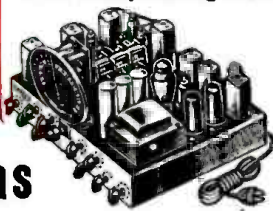

### PRACTICAL EASY-TO-APPLY DATA

The well illustrated, easy-to-follow large lessons will help you to find and master all radio faults. You will enjoy getting radio knowledge this easy way. Facts which always perplexed you will be cleared up in a jiffy. You will be pleasantly surprised in how quickly you will be able to locate all faults in radio sets. How easy it will be to make in minutes the radio repairs which used to take hours. Plan to try the complete course in your own home without any risk or obligation—see coupon below.

### SATISFACTION GUARANTEED

Use coupon to order your COURSE for 10-day examination. Look over the material, read a few lessons, apply some of the suggestions and servicing hints. Then decide to keep all the lessons at the bargain price of \$2.50 (full price), or return the material and get a cash refund.



### NO-RISK TRIAL COUPON

*Supreme Publications*

PUBLISHERS OF RADIO BOOKS, MANUALS, AND DIAGRAMS

9 S. Kedzie Ave.,

Chicago 12, Ill.

Ship the complete Radio Course for 10 days use. I must be satisfied or you will refund my money.

- I am enclosing \$2.50, full price. Send postfree.
- Send C.O.D. I am enclosing \$..... deposit.

Name: .....

Address: .....

(Use Coupon or Write Order in a Separate Letter)

## Supreme Publications

The purpose of all *Supreme Publications* is to help radio servicemen in their work and to aid other men to enter this profession. All of our manuals are practical and deal with real radio problems. Essential theory where needed is clearly explained and connected with practical radio work.

Since we first began publishing technical radio books back in 1932, almost a million various manuals, courses, books, and pamphlets issued by us have been used by radio servicemen of America. We judge by the thousands of kind and flattering letters that we have served well. We will continue to try to publish needed radio information in practical, easy-to-use form, and we will continue to sell these publications at a low price with a guarantee of satisfaction or money back.

Sincere thanks is extended to our friends and readers in the radio servicing profession. Our thanks is also given to 397 active radio jobbers and 79 book stores where *Supreme Publications* are sold.

If you are not familiar with our other titles, please write for a catalog sheet.

## SUPREME PUBLICATIONS

9 S. Kedzie Ave.

Chicago 12, Illinois





# Peak Performance

Raytheon High-Fidelity Tubes are the *serviceman's* tubes . . . performance-engineered and precision-built to provide complete satisfaction for your customers.

To protect your interests, they are distributed only by legitimate wholesale radio parts distributors in your area.

Switch to Raytheon Tubes *now* . . . and be on the lookout for a revolutionary merchandising program developed by Raytheon to help qualifying service-dealers increase their profits through building public trust and confidence.

Copyright 1945

*Raytheon Manufacturing Company*

RADIO RECEIVING TUBE DIVISION

NEWTON, MASS. • LOS ANGELES • NEW YORK • CHICAGO • ATLANTA



Listen to  
"MEET YOUR NAVY"  
AMERICAN  
BROADCASTING CO.  
Every Monday Night  
Coast to Coast  
181 Stations



ALL FOUR DIVISIONS HAVE BEEN  
AWARDED ARMY-NAVY "E" WITH STARS

DEVOTED TO RESEARCH AND THE MANUFACTURE OF TUBES FOR THE NEW ERA OF ELECTRONICS





**A WAR-TIME DEVELOPMENT  
BRINGS US A POST-WAR  
ELECTRONIC ACHIEVEMENT!**

THE MODEL CA-11

# SIGNAL TRACER

## Features:

- **SIMPLE TO OPERATE**—only 1 connecting cable — **NO TUNING CONTROLS.**
- **HIGHLY SENSITIVE**—uses an improved Vacuum Tube Voltmeter circuit. Tube and resistor-capacity network are built into the Detector Probe.
- **COMPLETELY PORTABLE** — weighs 5 lbs. and measures 5"x6"x7".
- Comparative Signal Intensity readings are indicated directly on the meter as the Detector Probe is moved to follow the Signal from Antenna to Speaker.
- Provision is made for insertion of phones. Introduced in 1939-1940 Signal Tracing, the "short-cut" method of Radio Servicing became established as the accepted method of localizing the cause of trouble in defective radio receivers. Most of the pre-war testers (including ours) were bulky and required a number of connections before the unit was "set for operation" and included a tuned amplifier which had to be "retuned" to compensate for signal shift.

The new model CA-11 affords all the advantages offered by the pre-war models and only weighs 5 lbs. and measures 5"x6"x7". Always ready for immediate use without the necessity of connecting cables, this amazingly versatile unit has **NO TUNING CONTROLS.**

Essentially "Signal Tracing" means following the signal in a radio receiver and using the signal itself as a basis of measurement and a means of locating the cause of trouble. In the CA-11 the Detector Probe is used to follow the signal from the antenna to the speaker — with relative signal intensity readings available on the scale of the meter which is calibrated to permit constant comparison of signal intensity as the probe is moved to follow the signal through the various stages.

**NOW AVAILABLE FOR  
IMMEDIATE DELIVERY!**

The Model CA-11 comes housed in a beautiful hand-rubbed wooden cabinet. Complete with Probe test leads and instructions.

NET PRICE **\$18<sup>75</sup>**

Please place your order with your regular radio parts jobber. If your local jobber cannot supply you kindly write for a list of jobbers in your state who do distribute our instruments or send your order directly to us.

# Superior

**INSTRUMENTS CO.**

DEPT. R, 227 FULTON ST., NEW YORK 7, N. Y.





**NEW EDITION  
NOW READY**

# Audels RADIOMANS GUIDE

**Includes TELEVISION  
AND ELECTRONICS**

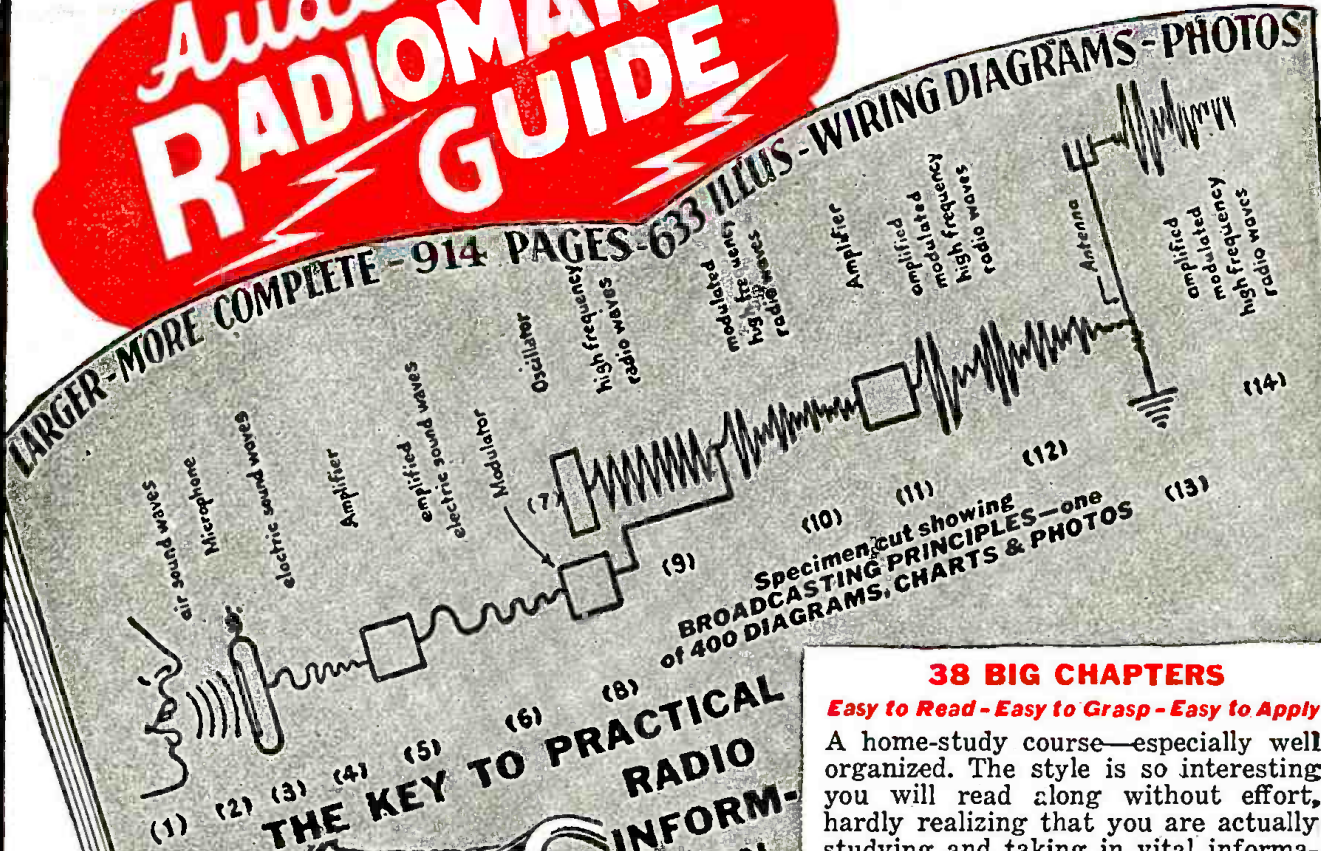

## THE KEY TO PRACTICAL RADIO INFORMATION

It gives you in usable form pointers on radio, including frequency modulation, television, etc. Also valuable inside information for Aviators, Marines, Commercial Operators and Technicians, Servicemen and Students.

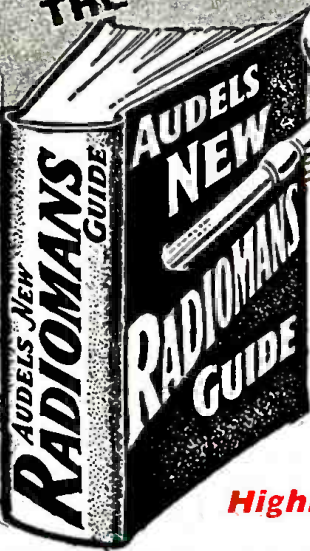

**Q AND A  
UNIQUE  
QUESTION  
and  
ANSWER  
METHOD**

**Highly Endorsed**

**1001 RADIO FACTS AND FIGURES  
A Complete Library In One Book**

AUDELS RADIOMANS GUIDE gives authentic Principles and Practices in Construction, Operation, Service and Repairs. Covers clearly and concisely radio fundamentals—Ohm's Law—Physics of sound as related to radio science—Measuring instruments—Power supply—Resistors—Inductors—Condensers—Transformers and examples—Broadcasting stations—Radio Telephony—Receivers—Diagrams—Construction—Control Systems—Loudspeakers—Antennas—AutoRadio—Phonograph Pick-ups—Public Address Systems—Aircraft and Marine Radio—Radio Compass—Beacons—Automatic Radio Alarms—Short Wave—Coil Calculations—Testing—Cathode Ray Oscillographs—Static Eliminations—Trouble Pointers—Underwriter's standards—Units and tables. REVIEW QUESTIONS—READY Reference Index.

**38 BIG CHAPTERS**

**Easy to Read - Easy to Grasp - Easy to Apply**

A home-study course—especially well organized. The style is so interesting you will read along without effort, hardly realizing that you are actually studying and taking in vital information. Audels Radiomans Guide gives you just the right amount of mathematics required to cope with radio problems successfully. You can solve, with the aid of this extraordinary book, practically every radio problem that comes up. At your finger tips is a complete index for instant use.



**7 DAYS' FREE TRIAL**

THEO. AUDEL & CO., Publishers  
49 West 23rd Street, New York 10, N. Y.

Mail AUDELS NEW RADIOMANS GUIDE for free examination. If O. K. I will send you \$1 in 7 days; then remit \$1 monthly until \$4 is paid. Otherwise I will return it.

**\$4**  
COMPLETE  
PAY ONLY **\$1** A MO.

Name \_\_\_\_\_  
Address \_\_\_\_\_  
Occupation \_\_\_\_\_  
Reference \_\_\_\_\_

**MAIL THIS COUPON TODAY**



## DYNAMIC HANDFUL SIGNAL TRACER

(Continued from page 98)

left on the bench and ordinary test leads can be applied to it to test the various stages of the defective set. There will be a slight detuning due to the long leads when this is done, but this does not interfere with the test that you are making. It may be necessary for you to retune the set a trifle.

### A.C.-D.C. SET TESTING

When testing an A.C.-D.C. set, make certain that the plug is inserted so that the chassis is connected to the grounded side of the line.

When testing A.C.-D.C. sets, only prod A should be used because both the set and the tracer have a common ground.

When testing an A.C.-D.C. set that uses a common positive on the filter block, connect prod C to first one negative of the condenser, use only the one that gives the least amount of hum.

When testing the first R.F. or detector stage of a loop operated set, an external antenna will be required on the set.

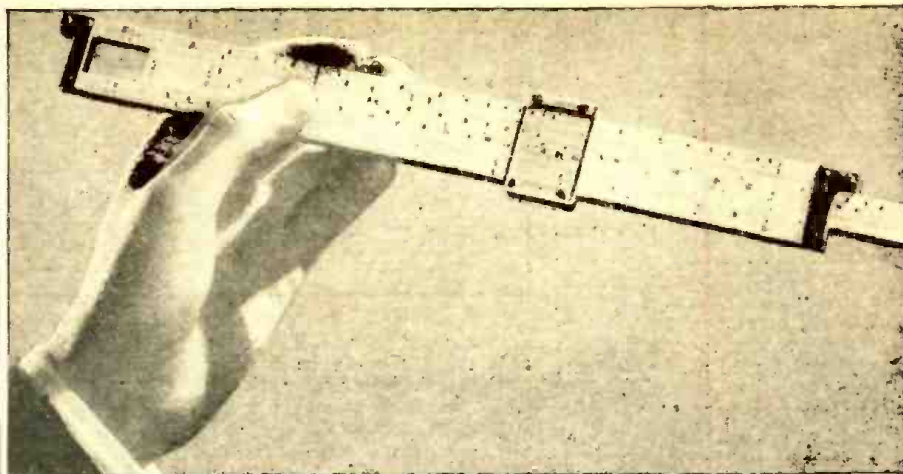

Can You "Measure Up" to a good-paying radio job with a secure peacetime future?

# "Post-War" Is NOW!

Don't be caught unprepared! Add CREI training to your present electronics experience—step ahead of competition!

What's ahead for you in the field of Radio-Electronics? One thing is certain. Now that peace is here, Radio-Electronics will surge forth as one of America's foremost industries, offering promising careers for radiomen with modern technical training.

NOW is the time to take the time to prepare yourself for the important, career jobs in radio-electronics engineering. You will find the knowledge gained from your CREI course useful almost from the beginning. Student C. Whitehead writes: "Your course has been of great value to me in that the knowledge I have gained has enabled me to meet technical situations satisfactorily and has given me the confidence to accept greater responsibility."

In our proved home-study course, you learn not only *how* . . . but *why*! Easy-to-read-and-understand lessons are provided you well in advance, and each student has his personal instructor who corrects, criticizes and offers suggestions on each lesson examination. This is the successful CREI method of training for which more than 10,000 professional radiomen have enrolled since 1927.

Your ability to solve tough problems on paper and then follow up with the necessary mechanical operation, is a true indication that you have the *confidence* born of *knowledge* . . . confidence in your ability to get and hold an important job with a secure, promising future. Investigate now the CREI home-study course best suited to your needs, and prepare for security and happiness in the New World of Electronics! Write for all the facts today.



WRITE FOR  
FREE 36-PAGE  
BOOKLET

"Your Opportunity  
in the New World  
of Electronics"

If you have had professional or amateur radio experience and want to make more money, let us prove to you we have something you need to qualify for a better radio job. To help us intelligently answer your inquiry—PLEASE STATE BRIEFLY YOUR BACKGROUND OF EXPERIENCE, EDUCATION AND PRESENT POSITION.

## CAPITOL RADIO ENGINEERING INSTITUTE

HOME STUDY COURSES IN PRACTICAL RADIO-ELECTRONICS  
ENGINEERING FOR PROFESSIONAL SELF-IMPROVEMENT

Dept. RC-11, 3224 16th St., N.W., Washington 10, D.C.

Contractors to U. S. Navy—U. S. Coast Guard—Canadian Broadcasting Corp.  
Producers of Well-trained Technical Radiomen for Industry.

MEMBER: NATIONAL COUNCIL OF TECHNICAL SCHOOLS

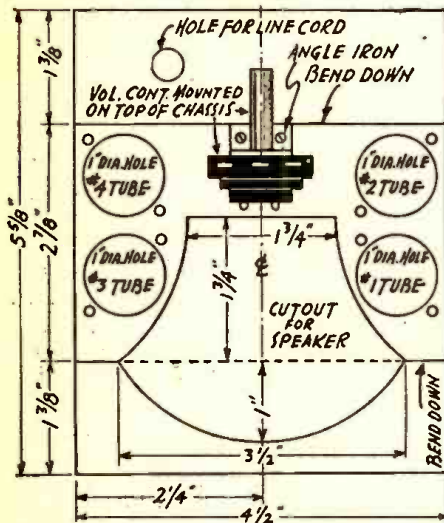

Chassis layout of the compact signal tracer.

There is no danger of a short circuit because of the blocking condenser. There is no danger of an electric shock because of the wooden cabinet insulating the chassis.

The short test prod is covered with a piece of spaghetti except the very tip, to prevent accidental shorts with the prod itself.

The cabinet was constructed from thin walnut panelwood, but if the serviceman should desire he can build the cabinet out of plywood.

Connections to phone jacks A B C are made after tracer is mounted into the cabinet.

The grid leads on the first tube should be made as short as possible to prevent hum.

When testing audio circuits, the short prod is removed and a shielded wire to which two phone tips are soldered at one end and a pair of alligator clips to the other end should be used. The shielded wire should be plugged in at B and the shield should be plugged in at C.

There are many uses for this tracer that you will find as you become better acquainted with it, the time required to build it will be repaid many times.







# Vibrator Tester

By HARRY L. BURCHAM

A VIBRATOR tester can be an extremely useful piece of "short-cut" equipment in the radio repair shop. The unit described here will check practically any type of vibrator under actual load conditions; a long-delayed need for the service shop.

The parts are mounted on a metal chassis cut to suit. The panel in this case was made of bakelite measuring 8 x 10 inches and 1/8-inch thick. A power supply is constructed lacking only the vibrators. The RFC's are hand wound of 25 turns of No. 10 enamelled close-wound wire, on a 1/2-inch form. The RFC in the rectifier cathode circuit is a 2.5-millihenry piewound or jumble-wound choke. The filter choke is a 6-henry, 100 ma. heavy-duty choke. If additional provisions are made for testing other types of vibrators the current-carrying capacity of this choke should be increased in accordance with the amount of current passing through it. A 2500-ohm, 50-watt bleeder resistor is placed across the filtered B-supply so that there is no danger of shock from undischarged condensers and also to provide a constant load in the circuit.

Two brass bolts, 1/4-inch in diameter, are used as the battery terminals. Sw. 1 is an ordinary single-pole single-throw toggle switch mounted on the panel. The sockets used are ordinary four and five prong tube sockets, J<sub>1</sub> and J<sub>2</sub> are meter or tip jacks for test prods. The vibrator voltage output can be read by inserting the test prods of a voltmeter into these jacks. The meter, M, can be any fairly accurate auto-type am-

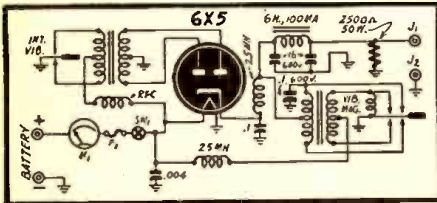

meter. This need not be an expensive meter but should have at least fair accuracy between about two to ten amperes so that the drain on the battery can be gauged. A 10-amp. 3AG fuse is placed in the meter circuit to prevent overload. A slow-action fuse or a circuit-breaker can be used to advantage here as the starting load can become great in proportion to the normal operating load current. If the vibrator contacts stick or fuse (as sometimes happens), the amount of current drained would be equivalent to a short circuit in the B-supply.

Below is shown the panel layout and chassis shield in position.

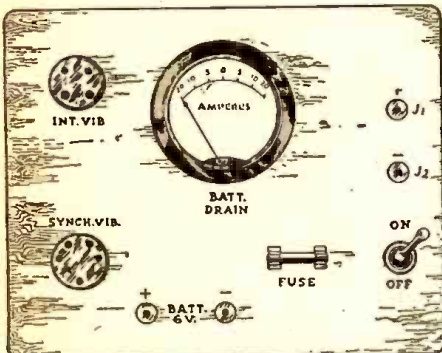

To test a vibrator, simply plug it into its proper socket, turn on the switch, and read the output voltage at J<sub>1</sub>, J<sub>2</sub>.



A background of Performance—over 50 years—is the inside story of the popularity that has brought leadership to Thordarson transformers.

Consumer acceptance will continue because Thordarson research and design engineers are never satisfied just keeping abreast of the times. These men are continually developing many transformer components which are instrumental in the production of new and better performing devices and equipment for the electronics industry.

Thordarson's well-tested methods of sales promotion and distribution will continue their joint task of making Thordarson Transformers, together with complete information on their applications and use, available to everyone in the field.

500 WEST HURON ST., CHICAGO, ILL.



ORIGINATORS OF TRU-FIDELITY AMPLIFIERS

## THORDARSON

ELECTRIC MANUFACTURING DIVISION

MACUIRE INDUSTRIES, INCORPORATED



## THERMOSTATIC METAL TYPE DELAY RELAYS

PROVIDE DELAYS RANGING  
FROM 1 TO 120 SECONDS

Other important features include:—

1. Compensated for ambient temperature changes from  $-40^{\circ}$  to  $110^{\circ}$ F.
2. Contact ratings up to 115V-10a AC.
3. Hermetically sealed — not affected by altitude, moisture or other climate changes. . . Explosion-proof.
4. Octal radio base for easy replacement.
5. Compact, light, rugged, inexpensive.
6. Circuits available: SPST Normally Open; SPST Normally Closed.

WHAT'S YOUR PROBLEM? Send for "Special Problem Sheet" and Descriptive Bulletin.

**AMPERITE CO.** 561 BROADWAY  
NEW YORK 12, N. Y.

In Canada: Atlas Radio Corp., Ltd.  
560 King St. W., Toronto

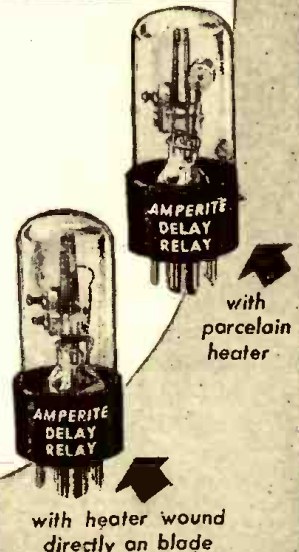



# BOOKS THAT TELL YOU HOW

3 new books that give you the basic knowledge for successful work in post-war radio.

## 1. PRINCIPLES OF RADIO FOR OPERATORS

By **Alberton**. Clear instruction on the operating principles of all parts of radio, including antennas, with full details about equipment and procedures for construction and operation. Many visual aids to help the beginner. \$3.75.

## 2. INTRODUCTION TO ELECTRONICS

By **Hudson**. A simply written but scientifically reliable explanation of the theory, construction, and uses of the various electron tubes and other electronic devices, showing their enormous potentialities for future developments. \$3.

## 3. INTRODUCTION TO PRACTICAL RADIO

By **Tucker**. An outstandingly clear, thorough training in the basic principles of radio circuits and their components, with full explanations of the necessary mathematics at the points where it is used. \$3.

### FREE EXAMINATION

By using the coupon below you can procure copies of these books to look over for 7 days without cost or obligation on your part. Send for your copies today.

## Special note to Dealers

### YOU CAN MAKE A DOUBLE PROFIT THROUGH HANDLING BOOKS

- Books bring you better buyers. They stimulate the interest and knowledge that makes steady customers. The more your customers learn about radio the more they will buy from you.
  - Books are a profitable stock item. Our trade discounts allow you a good profit on each sale. Our wide promotion insures their sale without effort on your part.
- Let these books be salesmen for you. Let them make you an easy profit. By returning the coupon below you can get copies for your book counter at the full dealer's discount. Cuts and copy for your catalog listings are also available. Write to our Technical Book Dept. for information.

The Macmillan Co., 60 5th Ave., New York 11

- Please fill my order for the books checked by number below, with the understanding that if I return them within 7 days my bill will be cancelled.
- Please fill my order, at dealer's discount, for \_\_\_\_\_ copies of the books checked.

SIGNED \_\_\_\_\_

ADDRESS \_\_\_\_\_

1. 2. 3.

# New Radio Patents

Conducted by I. QUEEN

## BALANCING SYSTEM

Paul D. Andrews, Schenectady, N. Y.  
Patent No. 2,380,389

WHEN an unbalanced load is coupled to a push-pull stage, the latter becomes unbalanced. For example, a grounded antenna coupled to an output stage as shown requires a decrease of one capacitance and an increase of the other to maintain balance. Since this must be done without disturbing resonance, it is a difficult procedure.

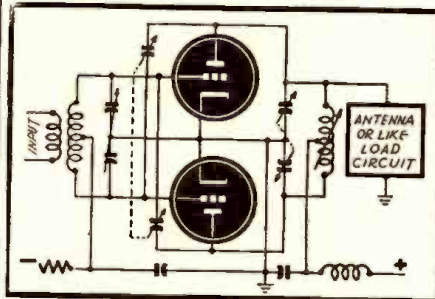

A special dual-condenser is used here to simplify adjustment. One section increases while the other decreases in such a manner that the effective capacitance of the two in series is a constant. The table illustrates how this may be accomplished for an effective capacitance of 5 Mmfd. An additional condenser may be connected across the coil for tuning which is independent of the balancing adjustment.

Rotor position in degrees	Capacity of one section	Capacity of other section
0	6.0	30.0
45	6.7	20.0
90	10.0	10.0
135	20.0	6.7
180	30.0	6.0

## RESONANCE INDICATOR

Charles A. Rosenkrans, Haddonfield, N. J.  
Patent No. 2,380,791

THIS arrangement can be used to indicate unmodulated current resonance without taking excessive power from the source or causing variations in its frequency.

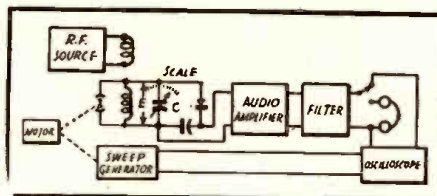

A motor simultaneously varies a small variable condenser and controls the sweep generator of an oscilloscope. When the tuning condenser (C) is tuned to exact resonance with the R.F. source, the amplitude of the voltage (E) will vary as at (a) in the lower figure from B through resonance to D and back for each revolution of the motor. If the circuit is somewhat off resonance, the induced voltage will vary as at (b) from B' to D' and back. In the first case, the output after detection and audio amplification will be twice the frequency of that in the second case, since there are twice as many changes from minimum to maximum.

The filter is adjusted to pass only the fundamental frequency corresponding to the motor

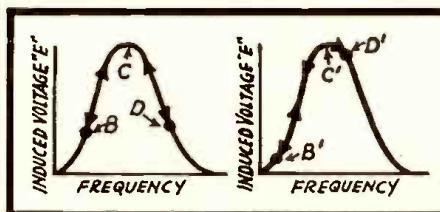

rotation speed. At resonance, a distinct null will result because there is no fundamental frequency output from the detector. Off resonance, the ratio of fundamental to harmonic output increases and is indicated either on the phones or the oscilloscope.

## PEAK CURRENT METER

Clarence W. Hansell, Rocky Point, N. Y.  
Patent No. 2,378,848

MEASUREMENT of the peak current of a circuit is very important in some types of work, such as those involving mercury-vapor rectifier tubes. There is difficulty using an oscilloscope for this purpose because the components are far above ground potential and lead to defocussing, stray fields, etc.

A low resistance R is used in this circuit and the peak voltage drop (proportional to the peak current) is rectified by a condenser-input rectifier circuit. The output is measured by a high-resistance voltmeter V. Such a circuit indicates proportionally to the peak voltage stored on the filter condenser C.

To secure maximum accuracy the rectifier circuit is first calibrated as in second figure. A standard ammeter A measures the current flowing, then the motor M is turned on, chopping up the current into on-off intervals. At the desired ratio of on-off, the meter V is calibrated in terms of the known current previously shown on A. Multiplying taps may be used on R.

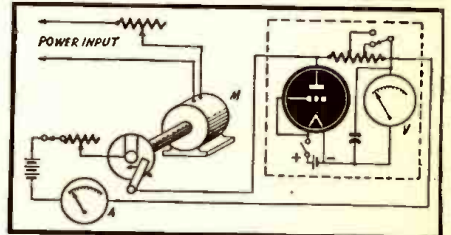
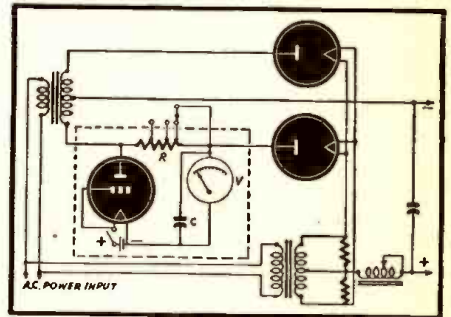

## PUSH-PULL AMPLIFIER

Patent No. 2,361,282

THIS improved circuit invented by Walter E. Gilbert, Philadelphia, Pa., eliminates need for a transformer or phase-inverting stage in produc-

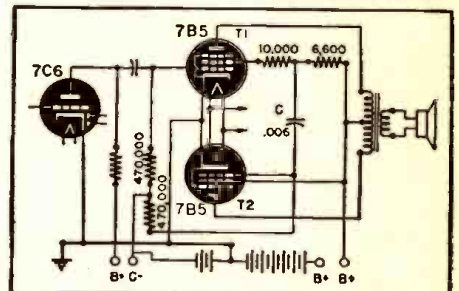

ing out-of-phase voltages. Screen voltage output from T1 is voltage-divided by the two resistors and passed through C to the control grid of T2 which is therefore 180° out of phase with that of T1. A push-pull voltage is thus delivered to a speaker or to further stages.

T1 may be any multi-grid tube, typical constants being shown.



## Book Review

**ELECTRONICS LABORATORY MANUAL.** By Ralph R. Wright. Published by McGraw-Hill Book Co. Stiff cloth covers, 5½ x 8 inches, 177 pages. Price \$1.00.

The author of this book has attempted to give the reader a manual of experiments in line with the lessons and experiments taking place in the classroom and physics laboratory. In this respect he has not accomplished his aim, for the twelve chapters cannot be classified as experiments. Rather, they are an exposition of basic electrical engineering problems in theory. The first seven and the twelfth chapters cover vacuum tubes. The other four deal with applications of vacuum tubes to power supplies, audio amplifiers, and rectification and inversion. The formulas are a bit too involved for the average radioman or experimenter, but the engineering student will find them in line with his studies. This book would find its place in the classroom or as an aid to home study, provided the lessons outlined had been fully explained beforehand. It is also entirely possible that the beginner, disregarding the formulae and concentrating on the text, might learn something about the functions of vacuum tubes, as, with the exception of the mathematics, the book is easy to understand.

The author has attempted to word the text so that the beginner in electrical engineering would be able to understand it, but has defeated his original purpose by formularizing it so that even an engineering student would not consider it an attempt at simplification.

A question-and-answer section at the conclusion of each lesson is useful as a guide for the instructor in preparing his tests. The reference bibliography following this section appears to be even more useful in determining the source of a given portion of material.

## CLOCK CONTROLS RADIO

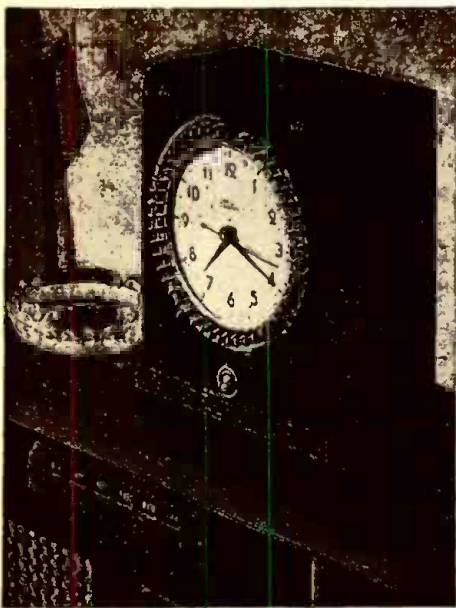

The "Selector", an electric alarm clock which will awaken the soundest sleeper to the strains of radio music, turn the radio on for selected programs throughout the day or night, and automatically switch the set off upon retiring—heads the list of post-war products developed by Warren Telechron Company.

The "Selector" can be used for starting a coffee percolator at a given time, switching household lights on and off, timing roasting operations and defrosting refrigerators.

# Immediate Shipment!

# RADIO PARTS

# and ELECTRONIC EQUIPMENT

# from CONCORD

What do you need in radio and electronic parts or equipment? If you think it's hard to get—if you need one or a hundred—order from CONCORD, by mail, by wire, by telephone. Our shelves are loaded with top-quality merchandise, nationally-known brands, complete assortments. Our radio technicians are prepared to work with you and expedite special requirements. Tell us what you need. We can probably supply it from our huge stocks—and ship it to you at once.

### Typical Values Available Now!

Money-saving prices on the four parts listed below are typical of thousands of unusual values offered by Concord.

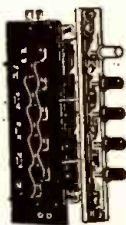

Push Button Switch, 4 Sections, each 8 pull double throw, with release button as illustrated. SB4029 Specially priced, 89c



Full Wave Vibrator Transformer, 6 Volts. Input—250 Volts. 60 MA. Output C.T. SB5000 Specially priced, 79c



I. R. C. type CS Dual Potentiometer 2500 ohm and 25 ohm. SB2007 Specially priced, 49c



Cornell-Dubilier type T1L6040, 4 mfd. 600 volt DC wkg. oil filled condenser. SB3015 Specially priced, \$1.49

### GET IT QUICKLY—from CHICAGO or ATLANTA

CONCORD is geared to present-day demands for fast service. Government, Industry, and Institutions—the biggest names in America—have discovered that they are more likely to get what they want from CONCORD, and get it sooner. Two huge shipping warehouses, one in CHICAGO and another in ATLANTA, are ready to fill and ship your orders immediately, no matter how large or small, no matter where you are located.

### Mail Coupon for FREE Copy "VICTORY CLEARANCE FLYER"

We have just published an exciting new Flyer offering thousands of standard-line, standard-quality parts and equipment at Victory Clearance prices. It contains exceptional values in many items you have not been able to obtain at any price. Consult this VICTORY CLEARANCE FLYER before you buy. It will save you money. Mail coupon below for your copy—it's FREE.

## CONCORD RADIO CORPORATION

### Lafayette Radio Corporation

265 Peachtree Street  
ATLANTA 3, GA.

901 W. Jackson Blvd.  
CHICAGO 7, ILL.

RUSH FOR FREE 64-PAGE "Book of Values"



CONCORD RADIO CORPORATION  
901 W. Jackson Blvd., Dept. RC-115  
Chicago 7, Illinois

Please send me a FREE copy of the "Victory Clearance Flyer" of radio and electronic parts and equipment.

Name .....

Address .....

City ..... State .....







# Small Electron Organ

By MARION BLACK

THIS simple and interesting musical instrument consists of an oscillator, two stages of audio amplification and speaker.

The oscillator is of the audio type and the pitch is varied by means of five keys controlled by the left hand. The right hand operates the key that sounds the note you have selected with the left hand. At lowest pitch my oscillator sounded high C. I set this pitch by means of a 50,000-ohm volume control in the grid circuit of the oscillator tube. Of course the pitch depends on the other parts I had selected for the circuit, which is shown in Fig. 1.

The tube I used for an oscillator was a 6K7-G with the plate and screen-grid connected together. I selected this type because it draws a light plate current and therefore would not burn out my pitch control while oscillating. I could have used a single power output tube to operate the speaker directly but when oscillating such a tube draws a very heavy current. My oscillating coil consisted of the primary of a push-pull output audio transformer.

I made the key-board by mounting the five note-selector keys and the one power key on top of an old radio cabinet and put the oscillator amplifier, speaker and power supply inside. By using the five keys in different combinations I had nine notes on my musical instrument. This is enough to play most popular, school and church songs. However, I had to count my high C note as middle C. My musical instrument would go as high as double high E without varying the pitch control. By decreasing this the highest note could easily be carried above the highest pitch of hearing.

The five left-hand keys I mounted in such a way that all five fingers could rest easily upon them and the right hand power key I moved to take care of the time of the music and the length of the note. Any note could be held as long as desired merely by holding down the power key. See diagram (Fig. 2) for arrangement of keys.

With all the keys down or in contact I had my lowest note. With all the keys but the power key up I had my highest note. The key operated by the little finger when held down alone give me the fifth note or high G. By holding High G down and pushing the other keys down one at a time I went down the scale a note at a time to high C. Then by releasing the G key my note was high A or one note above high G. Now by releasing the four remaining keys one at a time I went up the scale to double high E. For sharps or flats, which are just half way between two notes, I would need another key preferably operated by the right hand. I made my keys by simply screwing a short length of stiff brass



## Our Hat Is Off...

Our hat is off to those radio men, both military and civilian, who contributed so much to the successful completion of the war. Too, our hat is off to those radio servicemen and jobbers who were patient and understanding of the shortage of Rider Books caused by wartime restrictions, now removed.

Our hat is off (and our coat too), ready to tackle the peacetime radio problems in the civilian field. In the light of our wartime experiences we have planned a five year program which is right now developing in our own laboratories. From this research will result many innovations—and one of the most ambitious publishing programs we ever scheduled. It will bring to the student, the amateur, the serviceman, yes even the radio engineer the very information each must have, if he is to understand, and work in radio and the new fields of television and microwaves that will be commonplace in coming years. This is not a program of the future, it is functioning today. Next month will witness the publishing of the first of these new Rider Books. Announcements will carry complete details. Yes, our hat is off—and it's great to be back!



*John F. Rider*

JOHN F. RIDER PUBLISHER, INC., 404 FOURTH AVE., NEW YORK 16, N. Y.  
 "Publishers of Radio Technical Books Exclusively"

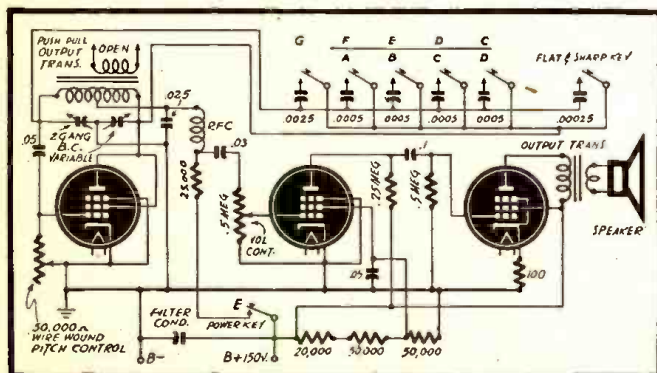

Fig. 1—The electronic "organ" employs a condenser-tuned oscillator.

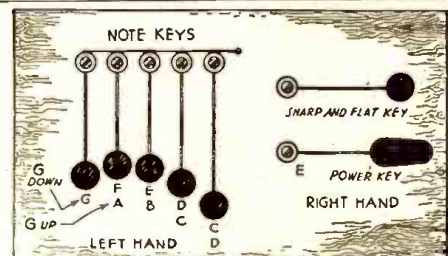
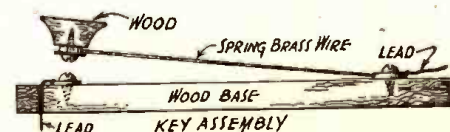

Fig. 2, above—Keyboard layout of the "electronic organ." Fig. 3, below—The keys are stiff copper or brass wires with wood knobs.



wire down to the top of the cabinets, then attaching a small round piece of wood to the other end of the wire for my finger to rest on (See Fig. 3). This was attached by means of a small screw, the head of which acted as one of the contact points. The other contact point consisted of another wood screw immediately below the first, screwed into the top of the cabinet where the other connection was made. There was enough spring in the wire to hold the contacts apart unless my finger was resting upon it.



# ALLEN Key Kits

Key Assortments to fit Hex-Socket Screws in the range of sizes the radio mechanic needs for everyday work.

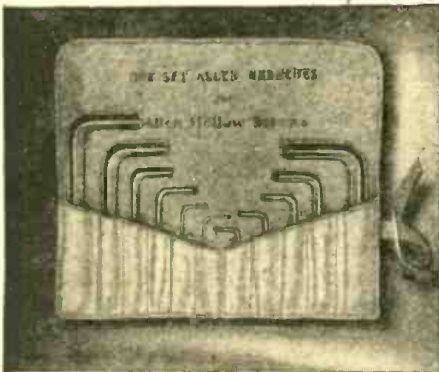

**KEY SET No. 603:** This canvas partitioned bag contains 11 short arm hexagonal keys which fit all screws from and including No. 10 up to and including 1/4" diameter set screws. List price \$1.75.

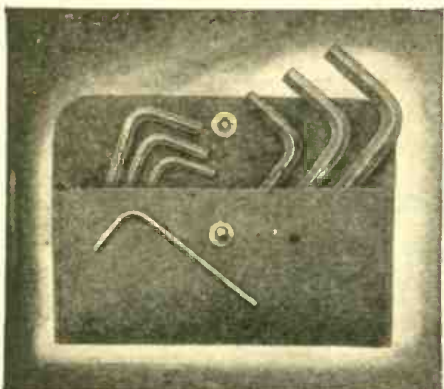

**JUNIOR KEY KIT No. 604:** Seven short-arm Allen Keys are included in this strong leatherette envelope. They fit the hex holes of sizes Nos. 8, 10, 1/4", 5/16", 3/8", 7/16" and 1/2" set screws and Nos. 4, 5, 6, 8, 10, also 1/4" and 5/16" cap screws. List price \$0.50.

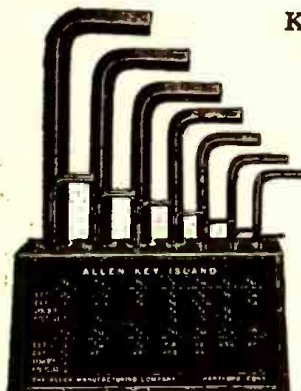

## KEY ISLAND

This handy key set contains 14 keys fitting all sizes of set screws up to and including 1/4"; cap screws up to 1"; shoulder screws to 1" and pipe plugs to 1". Container is plainly labeled to show the correct size key to use with each screw. No. 615; list price \$2.35.

Ask for complete listings of Allen Hollow Screw Assortments and Key Kits. Address inquiries and orders to Dept. E.

**THE ALLEN MFG. CO.,  
HARTFORD 1, CONN., U. S. A.**

## LICENSING PROBLEMS

(Continued from page 105)

### VOLUNTARY LICENSING

Next comes the sizable group of servicemen who may be classed as middle-of-the-roads. They would prefer voluntary licensing and to have the public view the license as a symbol and proof of skill, competence, knowledge, good business methods, and good business relations, or combinations of them. Licenses could be issued in various classes which would make them indicative of the type of servicing for which the holder is best fitted. A somewhat similar system is used in Canada.

Some possible advantages of this method are that: (1) the public is allowed to decide as to the benefits of licensing, (2) amateur repairmen may pursue their interests according to their abilities, and (3) governmental units may acknowledge the licensee's qualifications permitting him to service electronic devices used for public health and safety. This latter point may be accomplished in a manner similar to the way the National Electrical Code has been adopted as a basis for most electrical work.

Success of voluntary licensing would depend on examinations, licenses, and administration. It has been proposed that a fair and desirable method of examining and licensing could be formulated by cooperative interested groups such as the FCC, IRE, RMA, ARRL, Underwriters' Laboratories, radio servicemen representatives, and others with perhaps one of the group taking over the duties of sponsor and administrator. In this respect some lessons may be learned from the methods used in the National Electrical Code.

The above is but one of many suggested methods of accomplishing the results. However, it would have the advantage of including representatives of all parties concerned and it could be adopted nationwide. Other suggestions have been mentioned such as: Formation of private associations; allow the FCC to handle it; form cooperatives; and so forth.

### THE "FREE ENTERPRISERS"

Lastly comes the group of servicemen who oppose all forms of licensing. They believe in self-made business men and in competition, and claim that an efficient up-to-date serviceman at the head of an orderly and well designed shop and using good business methods has no need for license protection. They believe in freedom for enterprise and freedom for the worker, which conditions have been conducive to some of the greatest advances in the sciences and arts.

They point out the inherent weaknesses in licensing such as disadvantages of the apprenticeship system; possible graft and favoritism in examinations; many become frightened at examinations when their future is at stake; no guarantee of better work; it may be only a revenue raising measure; it may be used for political purposes.

Many believe that if establishment of responsibility is needed it should be accomplished by treating all businesses alike. This has been and could be accomplished by requiring all dealers, sellers, repairmen, in various lines to obtain an operating permit and post a bond of sufficient value to cover possible defrauding of customers.

The charge is also made that one license begets another and that it will be only a matter of time before licenses will be required for servicing many other items. In

this connection it might be mentioned one city recently had under consideration the licensing of oil-burner servicemen. Another, Toledo, Ohio, finally rejected an ordinance to license men installing and servicing both domestic and commercial refrigerators.

In favor of the opposition is also the possibility of failure in licensing. For example, several years ago one state enacted a compulsory type painters' license law with objectives very similar to those advanced by advocates for licensing of radio and electronic servicemen. After the law went into effect opposition began to rise, not only from the public but from many painters and amateur painters. After a short life the law was repealed.

Opponents of licensing also have the support of many amateur radiomen and operators and perhaps public opinion also. Recent information (Sylvania Survey) indicates a high percentage of the public is satisfied not only with the work of their radio serviceman but also believe he is charging them a reasonable price.

The points advanced against licensing are directed mainly against the compulsory type and licensing which may be used for restraining competition, eliminating amateur repairmen, and fixing prices. The points would be practically ineffective against voluntary licensing which could be used solely to indicate the qualifications of the holder.

Many other angles and points of view, not apparent here and now, may have a bearing on the subject. For instance, consideration should be given the fact that many former servicemen are now in the Armed Forces. What will be their reactions now and when they return later? The writer would therefore welcome comments from readers on all phases of the subject of licensing.

### MADISON ORDINANCE

"19.20 Licensing of Radio and Electronic Servicemen. (1) License to do Radio and Electronic Servicing. No person either individually, as a member of a firm or as an employee of any person, shall do any servicing or installing of radio or electronic equipment unless the person or persons or the employees who do the servicing and installing of said equipment have first obtained a license as required by and in the manner provided in this ordinance. Nothing herein shall prevent an apprentice indentured in the manner provided by chapter 106, Wisconsin Statutes, and paying the fee hereinafter provided therefor, from doing radio or electronic servicing or installation while in the employ of and under the direct supervision of a radio serviceman licensed as such under the terms of this ordinance. Nothing herein shall prevent any person, or his employees, from building, designing, installing or repairing equipment owned by such person. Electronic equipment is any device or devices which are directly or indirectly connected with or containing a vacuum tube having two or more internal elements for the purpose of effecting amplification or rectification, visual indicators, cathode ray tubes or in any way modifying or changing an electrical current in any manner or changing electrical energy to another form of energy, including arials and other devices used in connection therewith.

(2) Board of Examiners of Radio Servicemen. Examinations. The Board of Examiners of Radio Servicemen shall consist of six members, four of whom shall be appointed by the Mayor on the third Tuesday in April of each year or within ten days thereafter, and confirmed by the Common Council. The chief radio technician of the City of Madison shall be ex officio the fifth member of said board and the electrical inspector of

(Continued on page 144)







"I'M SURE OF FASTEST SERVICE FROM ALLIED"

# LARGEST and most complete STOCKS

Everything in RADIO and ELECTRONICS

FREE Helpful BUYING GUIDE

RADIO PARTS AVAILABLE -without priority

Over 10,000 items from all leading manufacturers . . . ready for rush delivery.

New Parallel Resistance and Series Capacitance

**CALCULATOR**  
Solves every-day problems—quickly!  
No. X37-960  
Postpaid . . . 25c



R. F. Resonance and Coil Winding **CALCULATOR**  
No. 37-955  
Postpaid . . . . . 25c

## 6 Radio Books for 75c

- Dictionary of Radio Terms. No. 37-751 10c
  - Radio Data Handbook. No. 37-754 25c
  - Radio Circuit Handbook. No. 37-753 10c
  - Radio Builders Handbook. No. 37-750 10c
  - Radio Formulas & Data Book. No. 37-752 10c
  - Simplified Radio Servicing. No. 37-755 10c
  - All Six Books No. 37-799 . . . . . 75c
- Write for Quantity Prices

ALLIED RADIO CORP., Dept. 2-L-5  
833 W. Jackson Blvd., Chicago 7, Ill.

Please send following (enclosed) . . . . .  
 FREE Guide     37-750     37-752     37-754  
 Calculator 37-955     37-751     37-753     37-755  
 Calculator X37-960     No. 37-799 (All 6 Books)

Name.....

Address.....

City.....State.....

**ALLIED RADIO**

# THIS RADIO RUNS ON GAS

By CARL R. LAWRENCE\*

**W**ITH the general expectation of new and unusual things to come in the postwar world, we are beginning to receive inquiries about a gas radio that we built several years ago. No attempt has been made to exploit it commercially, but it was—and still is—a great novelty.

The idea came from England. We simply put the radio together as an interesting experiment, using certain imported equipment for the power supply and adapting it to other locally manufactured parts.

A standard cabinet model radio, with conventional "A" and "B" dry batteries, was used. It was designed to operate on 1½-volt "A" battery and 90-volt "B" battery. No modifications were made on the radio except to substitute a thermocouple-type electric generator for the batteries.

The thermocouple principle of operation is based upon the fact that when the junction of two dissimilar metals is heated an electromotive force is set up. The simplest type of thermocouple consists of two wires of dissimilar metals joined together at each end. When one junction is kept warmer than the other one, a continuous flow of electric current takes place. The amount of current is dependent on the metals used and the difference in temperature of the hot and cold junctions. If a circuit contains several junctions, the total E.M.F. is the algebraic sum of the E.M.F. of the various junctions.

Electric current for operating the radio is generated by means of 80 thermocouples heated by a gas flame. A number of the thermocouples is connected in series to generate 1½ volts to replace the "A" battery. These thermocouples are connected directly to the radio tubes in the same manner as the battery would be. The remaining couples are connected in another series bank to supply current of low voltage (approximately 6 volts) to a power unit

\*Service Superintendent, Atlanta Gas Light Co.

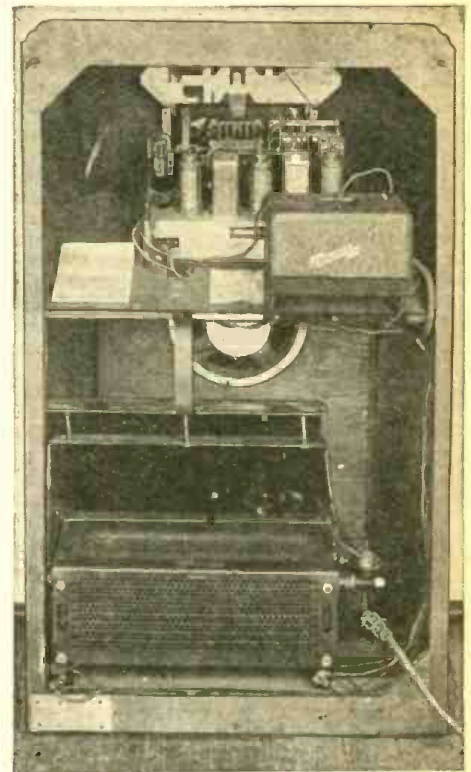

Back view of the gas-operated radio receiver.

which in turn steps up the voltage to approximately 90 for replacing the "B" battery. The power unit is similar to that furnished with automobile radios.

The thermocouples are rugged devices constructed to stand high temperatures, more like the type used in industrial furnace thermometers than the delicate meter couples which are more familiar to the radioman. They run with an ample safety factor and no trouble from breakdown has been experienced.

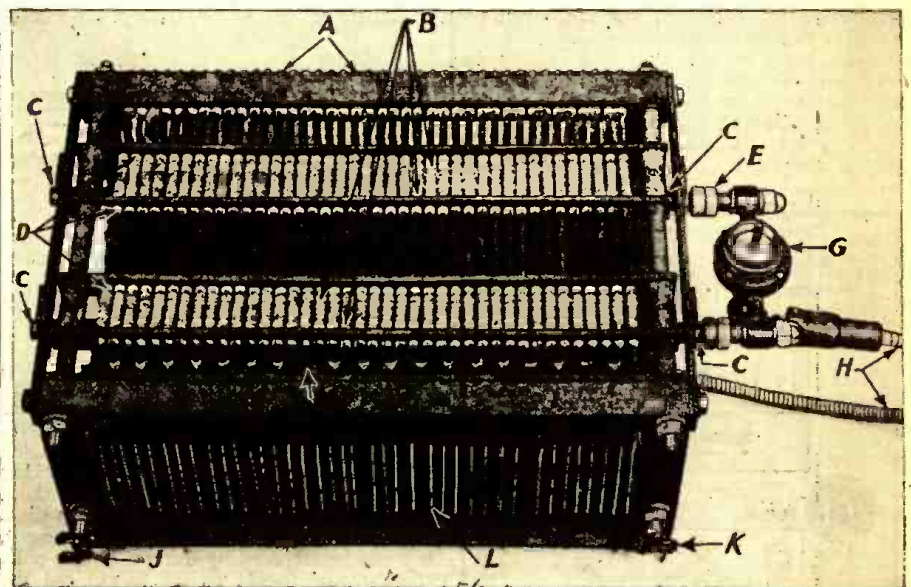

A—Cotters to secure assembly. B—Thermocouple units. C—End of gas burner. D—Porcelain insulators. E—Air shutter. G—Gas pressure regulator. H—Fuel line. J—Leads to left bank of thermocouples. K—Leads to right bank. L—Radiation fins. M—Division between banks.



## CAPACITOR-RESISTORS

(Continued from page 103)

This same idea can be applied to vary the speed of a clock, motor, etc., as long as you can find the voltage required, calculate the voltage drop, find the current

taken and apply the formula,  $X = \frac{V}{I}$  to

obtain the reactance. Then refer to Fig. 1 to obtain the value of capacity and your problem's solved. Simple, isn't it?

## A TRUE TONE CONTROL

(Continued from page 97)

(see Fig. 4), and formula No. 1 can be seen. Formula 1 is simply an expanded version of this, with A and B replaced with the equal of these equivalent resistors. This is the formula for finding these equivalent values A and B.

These calculated outputs were derived on the supposition that the 6CS provides constant voltage output, disregarding the effect of the coupling condenser which was finally increased to .25 mfd. In the same manner, the equivalent circuit is drawn for the other frequencies and the resultant output calculated for the various positions of the controls. The results of these calculations can be found in the table.

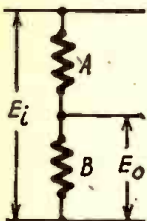

Fig. 4—Formula (1) on page 97 is simply an expansion of that for the common voltage divider at left. The output voltage is to the input as the total resistance of A and B to B.

Having found the output of the network for varying conditions, it is now possible to plot a graph with the curves passing through the known points. This is the graph shown in Fig. 2.

The response curve appears to have a two-decibel dip through 250 cps., but this is not apparent to the average listener. In fact, this may be desirable as it would provide compensation for the masking level of the residential noise of the surroundings.

The idea of calculating one's own tone control circuit will appeal to the average radio enthusiast; especially so when its relative simplicity is thoroughly understood. The satisfaction that comes from improved tonal reception is the designer's reward.

TABLE — GAIN AT VARIOUS FREQUENCIES

$E_i/E_o$	Output	Gain	Bass setting	Treble setting	
6.84	-16.7 db	- 1.7 db	N	N	100 cycles
2.18	- 6.9 db	+8.6 db	B	N	
27.4	-29.8 db	-14.3 db	A	N	
7.41	-17.4 db	- 2.0 db	N	N	500 cycles
3.8	-11.6 db	+3.9 db	B	N	
10.95	-20.8 db	- 5.3 db	A	N	
4.0	-12.0 db	+3.5 db	N	B	500 cycles
12.7	-22.0 db	- 6.5 db	N	A	
6.36	-16.1 db	- .05 db	N	N	
2.15	- 6.7 db	+8.8 db	N	B	2500 cycles
26.4	-28.5 db	-13.0 db	N	A	
6.98	-15.5 db	0.0 db	N	N	
1.88	- 2.8 db	+12.7 db	N	B	10,000 cycles
70.9	-37.0 db	-21.5 db	N	A	

N—NORMAL      B—BASS      A—ATTENUATE



## "VOMAX" Measures EVERY Voltage

The secret of the overwhelming demand for "VOMAX" is just that simple. With it you can measure every voltage in radio receiver design and servicing.

"VOMAX" handles a wide range of d.c. and a.c. voltages at meter resistance so astronomically high that you can measure directly and accurately every such voltage. It goes far beyond conventional volt-ohm-ma-meters. For "VOMAX" will measure every a.f., i.f. and r.f. voltage from 20 cycles right up to beyond 100 megacycles.

This remarkable post-war instrument gives you vitally important visual dynamic signal tracing. Read the briefed specifications at right . . . practically a complete service station by itself . . . see how "VOMAX" makes you the master, no longer the victim, of tough service jobs. Imagine the time you'll save, the increased efficiency, the multiplication of your profits when you put "VOMAX" to work and can at last measure every voltage.

Requiring no priority and despite heavy demand, your favorite jobber can arrange quick delivery . . . if you act fast.

1. Brand new post-war design . . . positively not a "warmed-over" pre-war model.
2. More than an "electronic" voltmeter, VOMAX is a true vacuum tube voltmeter in every voltage/resistance/db. function.
3. Complete visual signal tracing from 20 cycles through over 100 megacycles by withdrawable r.f. diode probe.
4. 3 through 1200 volts d.c. full scale in 6 ranges at 51, and in 6 added ranges to 3000 volts at 126 megohms input resistance. Plus-minus polarity reversing switch.
5. 3 through 1200 volts a.c. full scale in 6 ranges at honest effective circuit loading of 6.6 megohms and 8 mmfd.
6. 0.2 through 2000 megohms in six easily read ranges.
7. - 10 through + 50 db. (0 db. = 1 mv. in 600 ohms) in 3 ranges.
8. 1.2 ma through 12 amperes full scale in 6 d.c. ranges.
9. Absolutely stable—one zero adjustment sets all ranges. No probe shorting to set a meaningless zero which shifts as soon as probes are separated. Grid current errors completely eliminated.
10. Honest, factual accuracy:  $\pm 3\%$  on d.c.,  $\pm 5\%$  on a.c., 20v through 100 megacycles;  $\pm 2\%$  of full scale,  $\pm 1\%$  of indicated resistance value.
11. Only five color-differentiated scales on 4 3/4" D'Arsonval meter for 51 ranges (including d.c. volts polarity reversal) eliminate confusion.
12. Meter 100% protected against overload burnout on volts/ohms/db.
13. Substantial leather carrying handle. Size only 12 3/4" x 7 3/4" x 5 3/4".

Send postcard for free catalog of measurement and communication equipment.

OVER 34 YEARS OF RADIO ENGINEERING ACHIEVEMENT

*McMurdo Silver Company*

1700 MAIN STREET, HARTFORD 3, CONNECTICUT

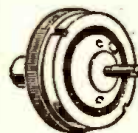

## "WONDER" ELECTRIC BUTTON

Most interesting electrical apparatus ever discovered. Make your own telephone-Amplifier Detectiphone. Transmit your voice or music to distant rooms. Perform hundreds of fascinating experiments. So tiny it can be concealed in dozens of places. Send \$1 now for button and free 5,000 word instruction booklet with 50 illustrated experiments. SPECIAL OFFER: 6 buttons and booklets sent postpaid for \$5. Write now to

**BUCK MFG. COMPANY**      North Aurora, Illinois

A foot-operated automobile radio tuner is announced by Zenith. Volume is controlled by sliding the foot along the rubber-covered knob. Light pressure of the foot mutes the set—heavier pressure tunes in stations.



# FREE!

The famous 64-page, fact-packed book that has stimulated thousands of men!



"Forging Ahead in Business" is a practical, thoughtfully-written book with "punch" and common sense on every page. It carries a message of vital importance to every man who wants to make more money, get a better job and improve his station in life!

### Partial Contents:

- Law of Success
- Forging a Career
- Organized Knowledge
- Highway of Achievement
- Making Decisions
- Failure and Success

### Noted Contributors

Among the prominent men who have contributed to the Institute's training plan, which is described in "Forging Ahead in Business," are: Thomas J. Watson, President, International Business Machines Corp.; Clifton Slusser, Vice President, Goodyear Tire & Rubber Co.; Frederick W. Pickard, Vice President and Director, E. I. du Pont de Nemours & Co.

Simply return the coupon below, and your FREE copy of "Forging Ahead in Business" will be mailed to you.

### MAIL COUPON TODAY

ALEXANDER HAMILTON INSTITUTE  
Dept. 331, 71 W. 23rd St., New York 10, N. Y.  
In Canada:  
54 Wellington Street, West, Toronto 1, Ont.

Please mail me, without cost, a copy of the 64-page book—"FORGING AHEAD IN BUSINESS."

Name.....

Firm Name.....

Business Address.....

Position.....

Home Address.....

## FLUX VALVE AERO COMPASS

(Continued from page 93)

hermetically sealed electromagnetic pulsing device with no rotating parts, mounted in a wing tip or tail safely removed from the disturbing influences of the cockpit electrical apparatus, load, etc. When rough air momentarily swings the flux valve out of the horizontal due to the movement of the airplane with its effect on the pendulum motion of the hanging valve, the resultant fluctuating signals might be expected to register an error. That this does not occur is due to the fact that the directional gyro effectively integrates all short period disturbances and oscillations.

The Flux Valve contains a pendulously mounted magnetic responsive element enclosed in an air tight cell filled with light oil. The oil serves to dampen oscillations and prolong the life of the unit. As it is extremely rugged, and contains no rotating parts, it does not need to be shock mounted and will require no maintenance.

The Flux Valve element is composed of a core, an exciting coil, and three pick-up coils. The core, which is made of laminated metal, having high magnetic permeability, is "Y" shaped with three legs equally spaced and joined in the middle. The exciting coil is mounted at the center of the three legs and a pickup coil is mounted on each leg. Each of the three pickup coils has collector segments at the end of the coil.

The Gyrosyn Compass uses magnetic North as a fixed reference. The flux valve acts as a responsive unit sensing its orientation (azimuth position) with respect to the magnetic meridian.

The core of the flux valve is excited by two independent magnetizing fluxes, a constant external one (the earth's magnetic field) which travels through the flux valve in from one side and out the other, and a varying one which is localized at the center of the unit, caused by the 400 cycle A.C. flowing through the exciting coil. For purposes of explanation one may speak of the action of the exciting coil as a magnetic valve at the center of the flux valve core. This valve is normally open but closes when the current is flowing through the coil. When the valve is opened the earth's magnetic flux is permitted to flow through the entire core, but upon closing the valve the flux stops flowing. By considering an

alternating current wave as in Figure 2a it is observed that there are two valve closings per cycle. This causes the flux

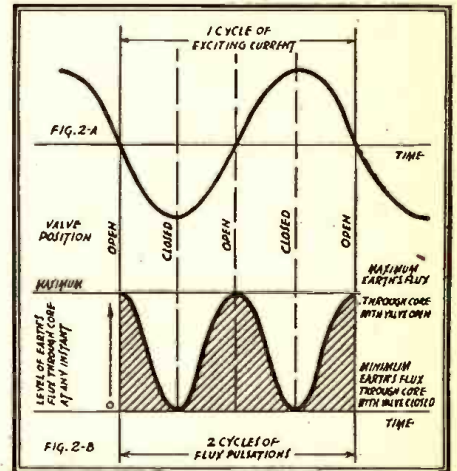
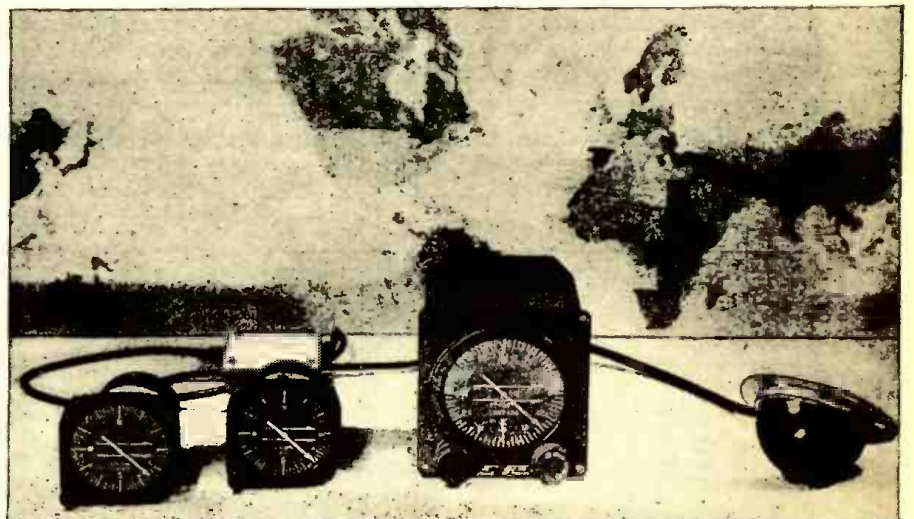

Fig. 2—Flux with the valve open and closed.

pulsations through the core to be of double the exciting frequency (see Fig. 2b).

This pulsating flux induces a voltage of double frequency (800 CPS) in the pick-up coils. The magnitude of the voltage in a particular coil varies directly with the amount of the earth's magnetic field in the line with its leg of the core. Thus the flux valve may be used to sense the magnetic heading. If this information can be obtained at a location in the aircraft which is remote from the disturbances of magnetic deviations and still provide the information directly to the pilot in the cockpit, one of the improved compass characteristics, that of unpredictable variations due to changes in the magnetic environment of the compass, would be achieved.

This is accomplished by simply connecting the three pick-up coils of the flux valve directly to another arrangement of three symmetrically set coils at 120 degrees from each other (known as a selsyn or signal transformer) but located at the cockpit. The resultant flux caused by these coils because it has been determined by the three coils of the flux valve and initiated by the



A complete Sperry Gyrosyn compass, showing the flux valve and two remote repeater units.



direction of the earth's field will reproduce the direction of the earth's field at the instrument panel.

A convenient means for indicating the angle relative to Magnetic North is to place in the influence of this resultant a rotatable coil selsyn rotor and attach a pointer to its axis of rotation so that the pointer position relative to a fixed dial, which is divided into degrees, will show the magnetic direction of the aircraft—if the flux valve does not rotate relative to it. Therefore, azimuth changes of the flux valve will produce equal angular rotations of the rotor null point. The rotor of the signal transformer is geared to the vertical ring of the gyro. When the rotor is at the null point, no signal will be induced in it, but whenever the rotor is moved relative to the magnetic field in the signal transformer, a signal will be induced into the rotor.

The position of the null point (or zero signal) of the rotor in this magnetic field is dependent upon the relative magnitudes of the three magnetic flux components in the stator. An azimuth change of the flux valve produces a reorientation of the pick-up coil in the earth's field which causes a redistribution of their voltages, resulting in an equal angular rotation of the rotor null point.

### THE ELECTRONIC CIRCUITS

This signal is fed to the amplifier where it is applied to the grid of the first 14E6 amplifier tube. This amplified signal is applied to the grid of the second 14E6 tube to be reamplified. Then the signal is matched against the 800-cycle reference voltage wave by means of a phase detecting circuit. The double frequency reference voltage wave is obtained from ripple of a full wave rectification of one phase of 400-cycle supply voltage, in a separate section of one of the 14E6 tubes.

The reference wave is applied between the center tap of the secondary of the interstage transformer and the cathode of the "push-pull" output tubes. The amplified flux valve signal is induced into the secondary where it mixes with the reference wave of the interstage transformer. The secondary leads from the transformer are connected to the two control grids of the 28D7 output tube. In one grid the reference wave and the signal wave tend to cancel each other. In the other grid they add and produce a large signal. The difference of the amplitudes of the signals applied to the two grids will produce a difference in the amount of current flowing in the two plate circuits. These plates supply two magnetically opposed coils, on both the precessor and annunciator.

If there is no signal, the two plate currents of the 28D7 are equal so that they will have no effect on the annunciator and precessor. Due to the swinging of the flux valve in rough air, the signal is continuously oscillating about its reference point. The output of the amplifier is led to the precessing coils of the directional gyro. As mentioned previously, the directional gyro will serve as a good stabilized azimuth indicator (heading indicator) for a period of approximately fifteen minutes. Therefore the control from the flux valve need not be rapid. By controlling the gyro at a very slow rate it cannot follow the momentary oscillations, but rather their average value. The gyro acts as an integrating or averaging device indicating the average direction of the horizontal component of the earth's magnetic field. Thus, the gyro is always controlled to give dead beat magnetic headings, irrespective of rough air, friction, unbalance and the effect of the earth's rotation.

The gyrosyn compass contains a gyro

which is the rotor of a special three-phase induction motor. The rotor and stator are enclosed in the gyro housing. Power is supplied through the receptacle at the back of the case. The gyro housing is free to turn (within limits) about a horizontal axis in the vertical gimbal ring. The vertical gimbal ring turns about a vertical axis on bearings in the top and bottom assemblies.

Any turns of the airplane in azimuth is evidenced by the case turning about the

vertical gimbal ring of the gyro. This rotation is transmitted to the pointer on the dial through a gear meshed with the vertical ring gear. Therefore the change in pointer position relative to the dial indicates continuously the airplane's heading relative to Magnetic North.

Due to residual friction and unbalance, the gyro has a tendency to tilt from its level position. This is overcome by a leveling system, consisting of a torque motor, (Continued on following page)

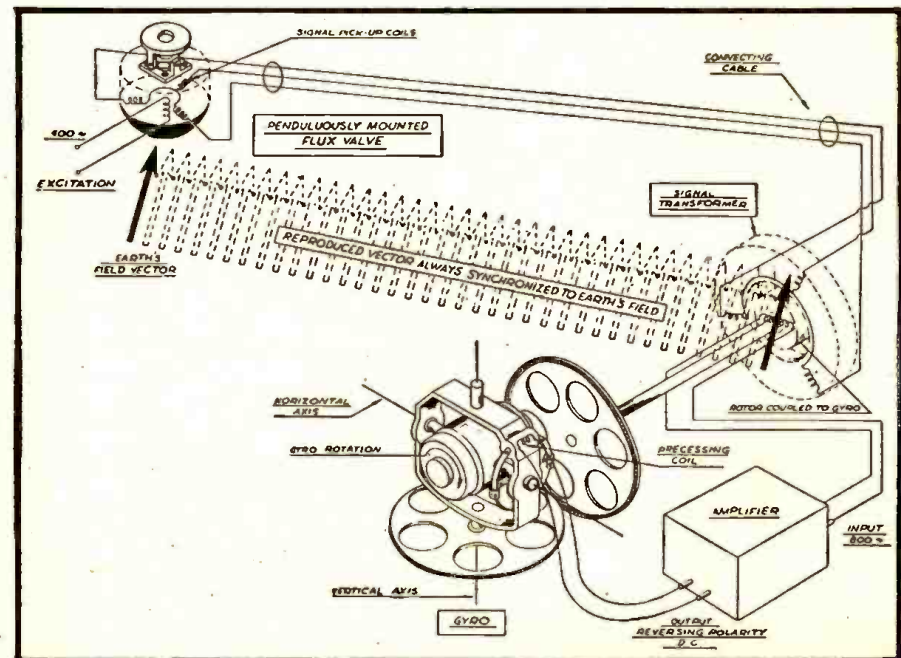

Showing how the Flux Valve transmits information to the gyroscope control apparatus.

## G-E TUBE CHECKER

Quick, easy, accurate tube checking which saves you time and trouble and keeps your customers happy—that's the job the TC-3P is built to do. Line Voltage and tube quality, or shorts, may all be checked on one selector switch. Individually operated switches permit placing the proper voltage on the proper pin of the tube. The G-E Tube Checker is available in either the Portable (TC-3P) or Counter Model (TC-3). Write: Specialty Division, Electronics Department, General Electric Company, Syracuse, New York.

**GENERAL ELECTRIC**

177-E1

Electronic Measuring  
Instruments

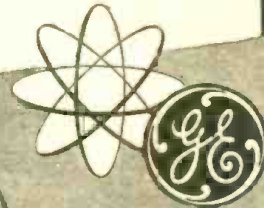

**TC-3P**





● Just eight numbers—a mere handful—yet these selected capacitances in Aero-vox paper tubulars can take care of most of your service needs at any time. They are ideal general-purpose capacitors. Keep these Aero-vox Type "84" paper tubulars handy for your everyday work.

**AEROVOX TYPE "84"**

Non-inductive paper sections in sturdy tubular casing.

Extra-wax-sealed ends. Thoroughly wax-impregnated paper casing.

Bare pigtail terminals that won't work loose or pull out.

Colorful yellow-black-red label jacket stamped with working voltage and capacitance value.

Eight selected general-purpose values are: 600 v. D.C.W.: .001, .002, .005, .01, .02, .05, .1 and .25 mfd.

● Ask Our Jobber!

**AEROVOX**  
Capacitors  
INDIVIDUALLY TESTED

AEROVOX CORP., NEW BEDFORD, MASS., U. S. A.  
In Canada: AEROVOX CANADA LTD., HAMILTON, ONT.  
Export: 13 E. 40 ST., NEW YORK 16, N. Y. Cable: "ARLAB"

## FLUX VALVE AERO COMPASS

(Continued from previous page)

levelling switch, and a voltage reduction transformer. The torque motor is composed of two parts—the squirrel cage which is attached to the vertical bracket assembly and the stator which is attached to the vertical gimbal ring. The stator coil has a fixed field winding and a control field winding.

The fixed field winding is connected to one phase of the 115-volt, 400-cycle, three-phase circuit and is constantly energized. The control field is connected through the conducting segments of the levelling switch to the auto-transformer. Power is intermittently supplied to the control field winding by the action of the levelling switch. The combined magnetic fields create a rotating field which applies a torque in one direction to the vertical gimbal ring, about the vertical axis. If the voltage of the power applied is reversed by the levelling switch segments, torque is applied in the opposite direction. This torque about the vertical axis precesses (slowly rotates) the gyro about the horizontal axis back to a level position. When the gyro is level, the torque is reduced to zero.

The gyro is caused to precess about the vertical axis in response to signals from the flux valve in the following manner: coils connected electrically to the amplifier are placed in the vertical ring of the gyro. Two permanent magnets are mounted on the gyro with like poles on the ends next to the precession coils. The direction of the resulting torque is governed by the polarity of the magnetic field produced by the coils. The torque applied about the horizontal axis then will precess the gyro about the vertical axis until the rotor of the signal transformer reaches the null position. The azimuth precession rate (heading change rate) is normally 3 degrees per minute.

The "Lock and set Pointer" mechanism is controlled by the left hand knob. As the knob is pushed in, the gyro is leveled and locked in azimuth. The pointer can be rotated and set by turning the knob. The rotors of the signal transformer and data transmitter rotate with the pointer. On releasing the pressure on the knob, the gyro is unlocked and free to indicate heading through the pointer. The setting should be done before takeoff or with the air-

plane in straight flight. Failure to perform the operation will cause no harm, but until the pointer precesses to the proper heading (at 3 degrees per minute) some delay will be experienced in obtaining proper indication of heading.



The Flux valve—heart of the Gyrosyn Compass.

The Gyrosyn Compass repeater duplicates the position of the pointer on the Gyrosyn Compass. It contains three stator coils symmetrically spaced at 120 degrees apart in the form of a "Y" and a rotor coil which is mechanically connected by a shaft to the repeater pointer. The unit is operated by connecting the three coils of the transmitter selsyn to the corresponding coils in the repeater. The rotors are energized by one phase of the 400-cycle supply. The voltage in the rotor of the transmitter selsyn will induce a voltage in each of its three stator coils. These voltages are reproduced in the repeater through its stator coils. If the pointer of the repeater does not correspond to that of the indicator, a torque will be produced on the rotor, due to the interaction of the rotor currents and the stator flux. This torque aligns the repeater rotor with the transmitter rotor.

Electronics has provided the solution to the perplexing problem of securing accurate heading in flight. Polar navigation is practicable, turning error is negligible, and stability is of the highest order. Remote indicating compasses such as the Sperry Gyrosyn, are the answer to the demand for a directional indicator which takes full advantage of modern science and stays apace of the aviation industry!

## BETATRON—ATOM SMASHER

(Continued from page 91)

of the magnetic field and the electron velocity acts to confine the whirling particles in an exact circular orbit. The guiding action of the magnetic field of the betatron is not unlike the circular guiding action of the cyclotron.

But the cyclotron, as has been said, accelerates the positively charged, massive atomic counterparts of electrons—the heavy ions, principally protons (hydrogen nuclei), deuterons (deuterium nuclei), and alpha particles (helium nuclei) and because of the very nature of its action is incapable of yielding electrons of energies much in excess of 100,000 volts. The cyclotron cannot accelerate electrons to the desired speeds, which are of the order of the speed of light, because of the inherent increase of mass of the electrons at these speeds. Neither can the conventional type transformer produce extremely high speed electrons be-

cause of the insurmountable insulation problems involved.

The betatron beautifully solves the difficulties both of increased electron mass and of high voltage insulation. The increasing mass of the electrons does not affect the betatron action since the electrons are swirled around in a vacuum. And the actual voltages employed are of low magnitude.

In the betatron the electron injector is located within the doughnut-shaped tube at a point in the median plane just outside the circle in which the electrons are ultimately confined and accelerated. An electron avoids striking the injector on successive revolutions following injection because of: (1) a shrinking of the electron's instantaneous circle to the final equilibrium orbit and, (2) a damped oscillatory motion of the electron about its instantaneous circle.

(Continued on following page)



To take a closer look into the operation of the betatron it is best to review two familiar experimental facts concerning the behavior of electricity, both well known to readers of *Radio-Craft*.

First is the fundamental generator rule—that an electromotive force is induced in a loop of wire which links a time-changing magnetic flux. This is the principle of the common transformer. Second is the fundamental motor rule—that a wire which is carrying an electric current and which is in a magnetic field experiences a force which is perpendicular both to the wire and to the magnetic field. This is the principle of the direct current motor.

The fundamental principle of transformer operation—that an electromotive force is associated with a time-changing magnetic flux—is familiar to everyone who has worked with electrical apparatus. But what is not always appreciated, however (even occasionally by electrical engineers), is the fact that the current-carrying wire through which the time-changing magnetic flux

passes is not essential to the presence of the electromotive force. The wire actually serves only as a comparatively low resistance path along which free electrons, released from atoms within the wire, travel. The EMF is there whether the wire is there or not.

Best proof of this is the successful operation of the betatron itself. For in the betatron the closed path through which the flux changes lies wholly in a vacuum.

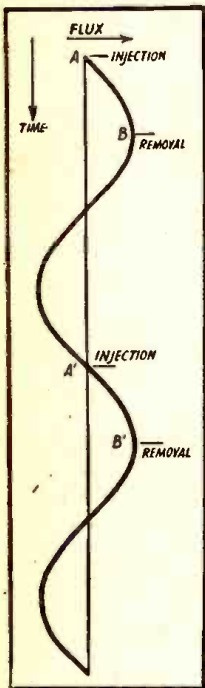

Fig. 3—The magnetic field cycle. Injection occurs at A, with acceleration continuing to B. The next electron burst is at A'.

And the electrons which spin this path—and which are accelerated by the EMF that is associated with the time-changing flux enclosed by the path—these electrons are confined to their orbit entirely by electromagnetic forces.

It is by the ingenious application of the second basic principle—the motor rule—that these electromagnetic confining forces are obtained and put to work. This principle is ordinarily demonstrated best by the (Continued on following page)

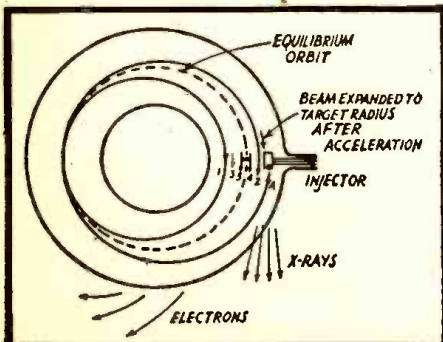

Fig. 4—Cross-section showing electron paths.

# BATTERIES! BATTERIES! BATTERIES

Available...NOW!

All You Want...Without Priority!

Batteries for portable receivers are now available **WITHOUT PRIORITY**. Listed below are various types of Signal Corps type batteries, fully guaranteed—available for immediate delivery. Mail us your order and check. Unlimited quantities are available immediately.



## "A" BATTERIES

Catalogue Number	Voltage	Dimensions in Inches	Price
Burgess 4FH	1½ Volts	2⅝" x 2⅝" x 4-1/16"	25c each
Eveready No. 718	6 Volts	3¾" x 5½" x 2¾"	45c each

plug in type

## "B" BATTERIES

Burgess Z30N	45 Volts	3" x 1⅞" x 4-17/32"	95c each
Eveready No. 467	67½ Volts	2-11/16" x 1⅜" x 3-11/16"	\$1.50 each

## "C" BATTERIES

Burgess No. 5360	4½ Volts	3" x ¾" x 2¼"	20c each
------------------	----------	---------------	----------

for all types of testers and other instruments

**RADIO ELECTRIC SERVICE CO.**  
OF PENNSYLVANIA  
N.W. COR. 7th & ARCH STS.  
PHILADELPHIA 6, PENNA.

Phone:—  
LOMBARD 6177  
LOMBARD 1951

HALLICRAFTERS ★ HALLICRAFTERS ★



## HENRY RADIO

is delivering

## HALLICRAFTERS

Henry Radio is delivering:

EC-1A receivers	\$29.50	SX-25 "	94.50
S20R "	60.00	SX-28A "	223.00
S22R "	74.50	S36A "	415.00
S39 "	110.00	PM-23 speakers	15.00

Mail, wire, or phone your order. No restrictions. No priority required. You can send \$5.00 deposit and pay balance COD. You can trade in your receiver. You can buy on terms. Write for full information. Tell us your wishes. We will help you get the best receiver for your use and will see that you are 100% satisfied. We have a complete stock of all amateur receivers, transmitters, parts, etc. Let's get acquainted. Your inquiries welcomed.

## HENRY RADIO SHOPS

211-215 N. Main St.  
Butler, Missouri

2331-35 Westwood Blvd.  
Los Angeles 25, Calif.

"WORLD'S LARGEST DISTRIBUTOR OF SHORT WAVE RECEIVERS"





**LEO'S SPECIAL!**

**Immediate Delivery**

Money Back Guarantee on this all-purpose

**Multitester**

Handles AC and DC Voltmeter, DC Milliammeter, High and Low range Ohmmeter. Size 5½x8x3¼. 3" meter with sturdy D'Aronson movement. Write for priority information.

**EVERYTHING IN TEST EQUIPMENT**  
We have it or can get it. Preferred delivery, quick service on all makes, all types. Hundreds of new items on order. Buy from Leo, W9GFQ.

**See Leo for WRL Radio Kits**  
priority required



Phono Amplifier Kits Complete with tubes, instructions. No. 1059... **\$9.50**



Code Oscillator Kits Complete with tube. Size 3"x6". No. 66-200 **\$4.95**

**Place Your Order Now!**  
Leo is making delivery NOW on

**HALLICRAFTERS**  
For preferred delivery, easy terms, and liberal trade-in allowance, write Leo, W9GFQ.

**DUAL FIL. TRANSF.**  
Fully Shielded  
110 V. Tapped Primary. Secondary, 5 volt @ 3 amp. and 6.3 V.C.T. @ 4 amp. No. 9-551... **\$2.25**

**EXCLUSIVE AT LEO'S!**

64 Page Parts Flyer... **FREE**  
Packed with hard-to-get items. Immediate delivery to radio repairmen. Usual priorities. Experimenters write Leo, W9GFQ, on how to get radio repair parts.  
Tube and Circuit Reference Book .....10c  
Handy Tube-Base Calculator .....25c  
Giant Radio Reference Map, Size 3½x4½ ft 15c



**MAIL TODAY**

Wholesale Radio Laboratories RC-11  
744 West Broadway  
Council Bluffs, Iowa

- Please rush Multitester No. 300, \$18.75 is enclosed, or Enclosed is \$\_\_\_\_\_ Balance C.O.D.
- Here's 10c, Send "Tubes and Circuits" Book.
- I want a Tube-Base calculator. 25c enclosed.
- Ship me your radio map. 15c enclosed.
- Send me your free flyer of hard-to-get radio parts.

Name \_\_\_\_\_  
Address \_\_\_\_\_  
Town \_\_\_\_\_ State \_\_\_\_\_  
I am  an amateur;  experimenter;  service man.



**QUICK SERVICE**  
Your order will receive my own personal attention. You'll get "same day" delivery service from the heart of the nation . . . on anything in radio.

Sincerely,  
Leo S. Meyer  
W9GFQ

**Wholesale RADIO LABORATORIES**

**BETATRON—ATOM SMASHER**

(Continued from previous page)

observed force upon a current-carrying wire which happens to be in a magnetic field. Again the part the wire plays is of secondary importance. Actually it may be shown that the force is not upon the wire but upon the moving electrons. The wire serves primarily to confine the electrons. Exactly the same type of force would appear to act on an insulating tube through which electrons might be fired. The field-velocity interaction force on individually charged particles is no novelty in these days of magnetic-deflection oscilloscopes, of mass spectrographs, and of magnetron

The magnetic field in the betatron must be space-shaped so that:

- (1) At the position of the desired circular orbit, the field-velocity interaction forces on the electrons always provide the *precise centripetal force* necessary to maintain the electrons in the orbit while they are simultaneously being accelerated;
- (2) At each and every radius just outside the desired circular orbit the centripetal forces are always in excess of the amount for confinement at this radius;
- (3) At each and every radius just inside the desired circular orbit the centripetal

Full-face view of the betatron, showing how the coils are fitted into the massive core-pieces and above and below the "doughnut" in which electrons are speeded up. The hook-shaped objects, left and right, are cooling vents to prevent heating during operation.

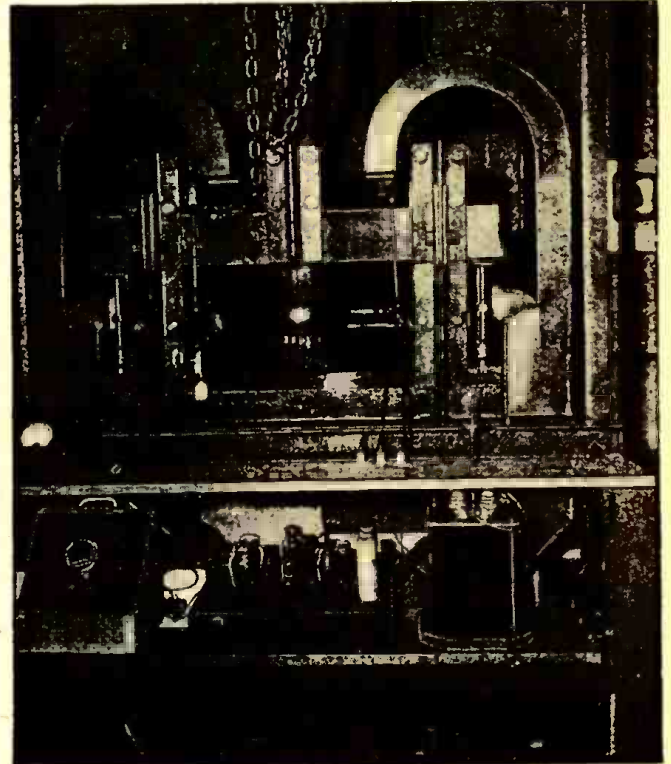

oscillators. But the real problem, the "trick" in the betatron is to space-shape the magnetic field to accomplish a number of highly important things.

Dr. Theodore J. Wang, brilliant young scientist who designed and constructed the 4½-million volt betatron now in operation at Ohio State University, gave this breakdown of the problem:

forces are always less than the amount for confinement at this radius;

- (4) Above the medium plane, in the vicinity of the orbital radius, downward forces are present;
- (5) Below the medium plane, in the vicinity of the orbital radius, upward forces are present.

According to Dr. Wang, it is necessary

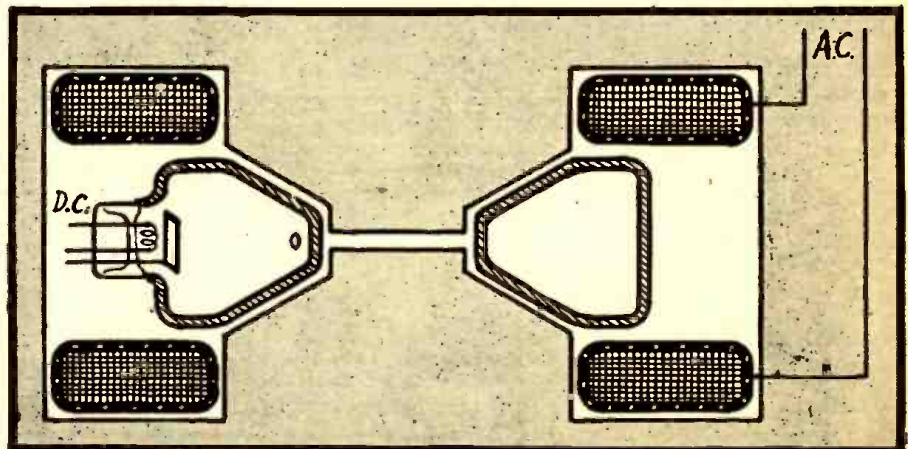

Fig. 5—Section through betatron showing evacuated chamber between tapered pole faces.



to satisfy the first condition but to do so is not sufficient. Because of the space-charge repulsive forces within the electron beam and because of the collision of electrons with residual gas molecules, the second, third, fourth and fifth conditions also must be met to make for stability of the circulating beam.

Meeting the second condition insures restoration to the main beam of any electrons which wander radially outward, and condition three insures return to the main beam of any electrons which wander radially inward. The fourth and fifth conditions provide vertical stability.

The secret of successful operation of the betatron lies in shaping the iron pole faces (enclosing the doughnut) in such a manner as to meet the specified five conditions. The pole faces must be tapered so as to present a narrow gap at the center and a gradually widening gap toward the outside (See Fig. 2).

Specifically, the pole faces must be designed to meet the requirements of: 1—total magnetic flux through the orbit amounting to just twice that which would obtain with a uniform magnetic field, and, 2—magnetic flux density in the neighborhood of the orbit falling off radially with a space rate which is not greater than the inverse first power of the radius. These two requirements can be shown to be equivalent to the foregoing conditions.

Added Dr. Wang: "The problem of actually designing pole faces to satisfy the necessary stipulations, while a somewhat tedious task, is actually a relatively simple one. It is essentially one of flux plotting."

As operated at present, acceleration of the electrons in the doughnut shaped tube of the betatron takes place for a quarter cycle of the magnetic field or for a period of about 1/1000th of a second (See Fig. 3). During this brief time the electrons attain a speed only 0.8 of 1 per cent less than the velocity of light, which is approximately 186,000 miles per second. The electrons spin an estimated 300,000 times around the orbit—a total distance of about 200 miles!

At the exact instant in the cycle when the electrons have reached the desired energy, the field-flux conditions for stability are upset by an electronically triggered discharge of a condenser through a set of "orbit-expansion" coils. These are single-turn coils which are mounted directly onto the pole faces just above and below the orbit. The momentary surge of current through these coils causes a strengthening of the central flux with little change, however, in the field at the position of the orbit. As a consequence, the field at the orbit is inadequate to retain the electrons and the big electrons spiral outward, striking the back of the injector and thus producing X-rays.

The half-angle spread of the X-rays cone

is such that  $\cos \theta = \frac{v}{c}$ , where  $v$  is the velocity

of the electrons before striking the target, and  $c$  is the velocity of light. The electrons after impact are distributed in speed and in direction, and under the influence of the magnetic field they proceed in a somewhat diverse pattern, some passing out through the walls of the doughnut (See Fig. 4). The removal intact of the collimated electron beam is one of the problems being worked on at present.

The efficiency of production of X-radiation at high energies in the betatron is very much greater than in the conventional X-ray machines. In the betatron it has been found unnecessary to safeguard the target against excessive heating. Efficiency of producing X-radiation at 100 million volts is nearly 100 per cent. In other words, almost all of the electron energy is converted into X-radiation, and practically none goes into heat at the target. This contrasts with an efficiency of the order of 1 per cent or less in a conventional X-ray machine which operates below 500,000 volts.

The betatron has already come to be regarded by medical research specialists as a most important potential in the war on cancer, particularly deep-seated cancers which in the past have been difficult, if not impossible, to treat. In physics the betatron already has made some notable contributions and many more are confidently anticipated by those who have designed and built and operated the new miracle machine.

Both the X-radiation and electron radiation will be utilized by medical science in deep therapy treatment. Medical scientists particularly are interested in the solution of the problem of how to control and con-

verge the electron radiation because preliminary studies indicate that electron radiation, unlike X-radiation, penetrates only to a definite depth, there gives off its curative effect, and goes no further.

In the field of academic research (as contrasted to applied research), betatrons of several hundred-million electron-volt potentials will do much to further the study of the fundamental nature of the atom. With betatrons of these higher potentials

it will be possible to produce man-made cosmic rays and to study mesotrons, recently discovered particles that are intermediate in mass between electrons and protons.

The betatron is still so new that only a limited number of studies have been made with the three machines known to be in operation in the world. Its inherent capabilities remain to be discovered—and exploited.

# Electricity

Models range from 350 to 35,000 watts. A. C. types from 115 to 650 volts, 50, 60, 180 cycles, single or three-phase and 400, 500 and 800 cycles, single phase. D. C. types from 6 to 4000 volts. Also available in dual voltage and special frequency types.

Onan

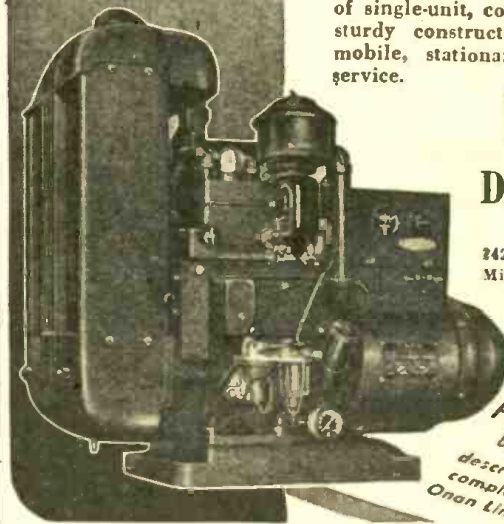

FOR RADIO AND ELECTRONIC APPLICATIONS

ONAN ELECTRIC GENERATING PLANTS supply reliable, economical electrical service for electronics and television applications as well as for scores of general uses. Driven by Onan-built, 4-cycle gasoline engines, these power units are of single-unit, compact design and sturdy construction. Suitable for mobile, stationary or emergency service.

Model shown is from W2C series; 2000 to 3500 watts; powered by Onan-built, two-cylinder, water-cooled engine.

**D. W. ONAN AND SONS**

2421 Royalston Avenue  
Minneapolis 5 Minn.

Write For Folder 690-A describing complete Onan Line

## SPEED UP REPAIRS WITH THESE G-C AIDS!



FREE STEEL CABINET

### G-C DIAL BELT KITS

Exact replacement woven fabric belts. Easy to install—no stretching—no adjustments—a perfect fit everytime. Kits come with 25, 50, 100, 200 or 300 belts.

### Get This New FREE Dial Belt — Drive Cable and Cabinet Repair Guide!

Pocket size 68 page book contains thousands of listings, specifications —time saving service instructions. Invaluable to every radio man. Get a copy from your jobber. If he cannot supply you, write us.



Immediate delivery on G-C Belts and Cables

Order From Your Radio Parts Jobber  
ALWAYS ASK FOR G-C PRODUCTS



**GENERAL CEMENT MFG. CO.**  
ROCKFORD, ILLINOIS



# SUPREME MODEL 504-A Tube AND Set TESTER...

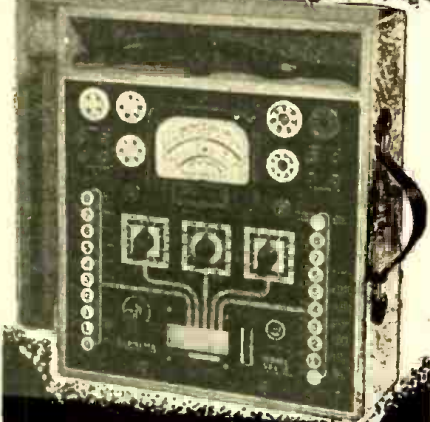

## ★ THE PORTABLE LAB THAT GIVES YOU *Everything!*

- ★ Design proven by over 5 years production of thousands of this model.
- ★ Operation as simple as ABC. Multi-section push-button switches do all work. Simply "follow the arrows" for tube checking. No roaming test leads for the multimeter.
- ★ Open face wide scale 4 1/4-inch rugged meter built especially for this tester—500 microampere sensitivity.
- ★ Each AC and DC range individually calibrated.
- ★ Professional appearance. Solid golden oak carrying case.
- ★ Guaranteed Rectifier.

## SPECIFICATIONS

DC MICROAMPERES: 0-500  
DC MILLIAMPERES: 0.2-5-10-50-250  
DC AMPERES: 0-1-10  
DC VOLTS—1000 OHMS PER VOLT:  
0-5-25-100-250-500-1000-2500  
AC VOLTS: 0-5-10-50-250-1000  
OUTPUT VOLTS: 0-5-10-50-250-1000  
OHMMETER: 0-200-2000-20-000 OHMS  
0-2-20 MEGOHMS  
BATTERY TEST: Check Dry Portable "A" and "B" Batteries Under Load  
CONDENSER CHECK: Electrolytics checked on English Reading Scale at Rated Voltages of 25-50-100-200-250-300-450 volts.  
TUBE TESTER: Emission type with noise test floating filaments, easy chart operation. Checks all receiving type tubes.  
POWER SUPPLY: 115 volts 60 cycle. Special voltage and frequency upon request.

The Cathode Ray  
Oscilloscope

YOU NEED THIS ROOM. "The Cathode Ray Oscilloscope," by Raymond Soward, fully explains basic operating principles of the Oscilloscope. New, 26 pages, written in the Serviceman's language. Send 25c to cover printing and handling costs, with coupon below.

SUPREME INSTRUMENTS CORPORATION,  
Greenwood, Miss.

I enclose herewith 25c. Please send me your new 26-page booklet, "The Cathode Ray Oscilloscope," by Raymond Soward.

Name.....  
Address.....  
City and State.....

## GI RADIO SERVICEMEN

(Continued from page 85)

pressure of today's tremendous business will never be answered.

"As your girl judges you by your appearance and the care you take in dressing, so the business house judges you by your letter. Every executive has acquired a sort of sixth sense whereby he can tell by merely glancing at a letter the type of man the sender is. To put it another way, you would not call upon the manager of a big radio company in your fatigue dress if you wanted to get a radio set agency for your community. Yet, if you sent out letters like the sample which we have before us to the 35 radio concerns which you mention, we are not at all surprised that you got nowhere. It is surprising that you got no replies at all.

"You should remember first of all that you are in a seller's market today. Every radio manufacturing company, with few exceptions, is over-worked and understaffed. They have a tremendous amount of requests such as yours and can afford to be choosy. When handwritten communications such as yours and others come into the office they are not taken seriously because the immediate impression is that it does not come from a business man. Today successful firms want to deal with business men only—men whom they think can do justice to their line. Even a neat typewritten letter composed faultlessly will meet with no attention whatsoever if it is not on a printed letterhead.

"That brings you to the next point just as important as the communication itself. That is the letterhead. It has been our observation, for a number of years, that a very large percentage of servicemen do not have letterheads and if they have they are so crude, printed on such cheap paper, and so badly composed that the average executive puts them aside with contempt.

"Recently, on a tour through the Middle-West we were in the office of an old line radio manufacturer who had manufactured only radio components before the war. Now he was bringing out a line of new radio sets. The manufacturer had inserted an advertisement in several radio magazines offering an informative booklet on their line.

"In a talk with the sales manager it developed that he was extremely disappointed at the poor response he had received in answer to the advertisement. He mentioned that his company had received thousands of letters but most of them had gone into the wastebasket. He had given strict orders to the clerks not even to send out sales literature unless the letter was on a regular printed letterhead and typewritten. That left only a relatively small percentage of letters whose writers he felt safe in contacting. The others in his own words he considered: 'Nothing but a lot of trashy kid communications.'

"Similar remarks have been made for a long time by other radio concerns who have come to believe that servicemen, as a class, are rather an unstable lot of untrustworthy individuals, most of whom do not even merit a reply. This may sound like strong language and is. It is so intended because radio publishers get it right along from many different sides.

"Now Mr. X, suppose you put yourself into the shoes of the radio manufacturers. Of course they want business. Of course they wish to sell as many sets as they can. But how are they to judge the radio servicing fraternity? If the radio manufacturing

## HARD-TO-GET PARTS

METERS

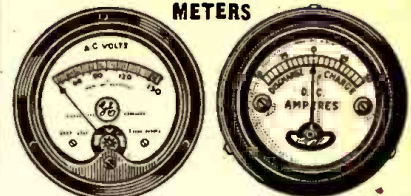

GENERAL ELECTRIC, A.C. Voltmeter, 0 to 150 Volts, type AO22, 3 1/2" flush mounting, Ship. weight 2 lbs.  
ITEM NO. 163  
YOUR PRICE ..... \$8.75  
GENERAL ELECTRIC, A.C. Ammeter, 0 to 150 Amperes, type AO22, 3 1/2" flush mounting. This is a 5-ampere A.C. meter and may be used as such with no change. For the 150-ampere range, a current transformer necessary. Shipping weight 2 lbs.  
ITEM NO. 164  
YOUR PRICE ..... \$7.75  
HOYT D.C. Ammeter, 50-25-0-25-50, type 531, 1 1/2". Shipping weight 1 lb.  
ITEM NO. 165  
YOUR PRICE ..... \$1.75

## ULTRA MAGNET

LIFTS MORE THAN 20 TIMES  
ITS OWN WEIGHT

LITTLE GIANT MAGNET

Lifts 5 lbs. easily. Weighs 4 oz. Made of ALNICO new high-magnetic steel. Complete with keeper. World's most powerful magnet ever made. The magnet and hobbyist will find hundreds of excellent uses for this high quality permanent magnet. Measures 1 3/4" x 1 1/4" Ship. Wt. 3/4 lbs.  
ITEM NO. 159  
YOUR PRICE ..... \$1.50



## GENUINE MICROPHONE TRANSMITTERS

Regular telephone transmitters taken from a large telephone supply company's overstock. Work perfectly on 2 dry cells. Can be used on P.A. systems, call systems, intercommunications, etc. A short-line telephone circuit, home-to-house or farm-to-farm phone lines, also to talk through your own radio or as concealed dictaphone pick-up. Useful replacements on battery-operated rural telephone lines.

THESE ARE GENUINE TRANSMITTERS, MADE BY KELLOGG, ERIC STROMBERG-CARLSON, excellent in appearance and operation. A remarkable value and one seldom offered in these times. Ship. Wt. 1 lb.  
ITEM NO. 160  
YOUR PRICE ..... \$1.50

## AMAZING BLACK LIGHT!!

Powerful 250-Watt Ultra-Violet Source

The best and most practical source of ultra-violet light for general experimental and entertainment use. Makes all fluorescent substances brilliantly luminescent. No transformers of any kind needed. Fits any standard lamp socket. Brings out beautiful opalescent hues in various types of materials. Swell for ornamental parties, plays, etc. to obtain unique lighting effects. Bulb only. Ship. Wt. 1 lb.  
ITEM NO. 158  
YOUR PRICE ..... \$2.45

## WESTERN ELECTRIC BREAST MIKE

This is a fine light-weight aircraft carbon microphone. It weighs only 1 lb.

Mike comes with breastplate mounting and has 2-way tuning adjustment so that it can be adjusted to any desired position. There are 2 woven straps; one around neck, the other around chest. Straps can be snapped on and off quickly by an ingenious arrangement. This excellent mike can be adapted for home broadcasting or private communication systems. By dismounting breastplate, it can be used as desk mike.

Comes complete with 6-foot cord and horn rubber plug. Finished in standardized plate, non-rustable. Shipping weight 2 lbs.  
ITEM NO. 157  
YOUR PRICE ..... \$2.55



## WATTHOUR METER

Completely overhauled and ready for immediate service. Designed for regular 110-volt, 60 cycle 2-wire A.C. circuit. Simple to install: 2 wires from the line and 2 wires to the load. Sturdy construction in heavy metal case, 8 1/2" high, 6 1/4" wide, 5" deep. Western Electric, St. Louis, Mo. or other available make. Ship. Wt. 14 lbs.  
ITEM NO. 33  
YOUR PRICE ..... \$4.95



## HUDSON SPECIALTIES CO.

40 West Broadway, Dept. RC-11-45, New York 7, N.Y.  
I have circled below the numbers of the items I'm ordering. My full remittance of \$..... (include shipping charges) is enclosed (NO C.O.D. ORDERS UNLESS ACCOMPANIED WITH A DEPOSIT.) OR my deposit of \$..... is enclosed (20% required). SHIP order C.O.D. for balance. NO C.O.D. ORDER FOR LESS THAN \$5.00. (New U. S. stamps check money order accepted.)  
Circle Item No. wanted: 163, 164, 165, 159, 160, 67, 152, 33

Name.....  
Address.....  
City..... State.....



firm is old and long established they probably have their own representatives who visit the different localities to find out for themselves who in the community is best equipped to handle their line. If the serviceman has a well-run shop, if he is known in his community, there will be little difficulty. It is then a simple matter to choose a representative for the line.

"But take new concerns, of whom many are springing up now, who are looking for live servicemen to represent their product. They have nothing to go by except perhaps mailing lists, which are not always helpful, particularly at this time when a large percentage of servicemen had gone to war and closed up shop. They do not know when these men will return or how to contact them. They can of course get every telephone directory in the country, look in the classified sections and make up their own list, which indeed many have done. Some firms feel that if the man is listed in the classified directory and has a telephone he must be in business, so that too counts.

"But when you, Mr. X, break in 'cold' on a firm whose line you wish to represent, they have no means of judging you except by your own representative—AND THAT IS YOUR LETTER. THAT AND ONLY THAT IS THE TEST. If your letterhead and your letter inspires confidence and looks as if you were somebody, you may be certain that a reply will be forthcoming. Businessmen as a rule answer correspondence if the letter looks worthwhile and inspires confidence. If you were on the other side of the fence you would do exactly the same thing. Have we made ourselves fully understood?"

Mr. X took a deep breath and sadly admitted to the whole indictment and that perhaps, he had been negligent. Too negligent in fact for his own good. He wanted to know further details on how to proceed, if we were in his shoes.

We pointed out to him that the radio service fraternity was not as bad as it was painted. Having worked with servicemen for some 15 years we have come to know them pretty well. We know that there are thousands of worthwhile servicemen who never got anywhere simply on account of slipshod business methods. We told Mr. X that we knew of a servicing concern whom we turned down some years ago when they wanted to buy \$10.00 worth of radio books. Their letterhead was of the cheapest imaginable type and the letter was written on an old battered typewriter. The letters could hardly be deciphered. By chance we went through the community one day and found out that this concern had the most thriving business in the town. The owner who had come up the hard way, evidently never appreciated what a letterhead or a letter meant and he did not think it important at all. We later found out that the concern actually was rated \$15,000 first credit, but his representatives which he sent out for years—namely the mangled letters—did not give any inkling of this whatever. This case is by no means an exception. There are thousands of them. It is simply lack of attention to details and carelessness.

If we were a serviceman we would invest—particularly at this time—in the most expensive letterhead that we could buy. We would have a first-class printer design it carefully and make it as impressive as possible. If we could not have it done in our own small community, we would make a special trip to a larger city where there are good printers who specialize in this sort of thing. It would not be necessary to have a steel engraved letterhead such as banks use, but we would insist on an excellent type of bond paper, water-marked if possible—it does not cost much more. Then we would

invest in a *good* typewriter. If we cannot typewrite ourselves, we would get somebody in our community to do the work for us, because if we have a beautiful letterhead, yet have our letters typed by an amateur, *that is worse than not having a letterhead at all*. Every community has someone who can do professional typewriting. If we could not get a stenographer or typist for ourselves, for the time being we would see to it that each and everyone of our communications would be handled in this manner. A telephone number should also be given, because that is one of the first points any sales manager will automatically look for.

Then if we were an ex-serviceman we would print the discharge emblem (which is reproduced in the first part of this article), in one of the corners of the letterhead.

Yes, businessmen do have a certain feeling toward discharged men of the armed services. Other things being equal, many a sales manager who may be an ex-serviceman himself, will often favor another serviceman if he knows that he is dealing with one.

It is of course not necessary to say or mention in the letter that you are an ex-serviceman. Printing the insignia on your letterhead is a dignified means of conveying the information to the people with whom you are doing business. We asked our caller if we had made ourselves plain. The answer was:

"Yes, all too plain. Now please tell me where I can go to have a *good*, first-class letterhead printed in a hurry?"

## SW AND INDUSTRIAL TUBE

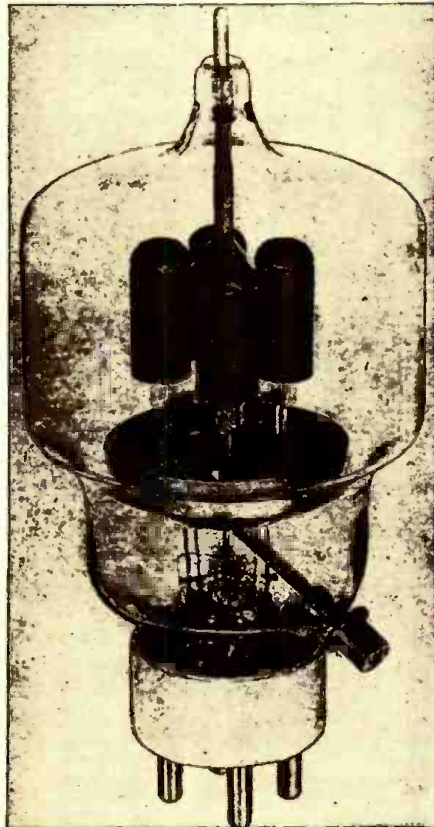

This unusual-looking tube, the new Eimac 304-TL, is an example of modern shortwave technique in electron tube design. A triode, it effectively combines four tubes in a single envelope. Characteristics are suited for television, industrial heating and applications requiring similar tube features.

# AT LAST!!

## A Complete, Practical Handbook of Present-day TELEVISION

Now, the tremendous opportunities in the field of television are brought within your reach—by means of this crystal-clear book. Written in plain English, concise and up to the minute, it makes television *easy* to understand. There is no mathematics to confuse you and make explanations difficult to follow. Hundreds of vivid illustrations bring every fact and point right before your eyes. You'll be amazed at how simple television can become with



# TELEVISION SIMPLIFIED

by MILTON S. KIVER

Associate Instructor in radio, U.S. Army Air Forces. Formerly Instructor in radio, Illinois Institute of Technology.

This brand-new, authoritative handbook not only contains all the information you need for success in television; but covers the trouble shooting and repair of radio sets. Beginning with a clear, overall picture of the entire field; it breaks down the television receiver into its component parts and circuits. It analyzes them, step by step; showing how they are formed, the roles they play, and their operating characteristics.

### BRIEF OUTLINE OF CONTENTS

The Television Field; Ultra-high Frequency Waves and the Television Antenna; Wide-band Tuning Circuits, Radio-frequency Amplifiers; The High-frequency Oscillator, Mixer and Intermediate-frequency Amplifiers; Diode Detectors and Automatic Volume-control Circuits; Video Amplifiers; Direct-current Reinsertion; Cathode-ray Tubes; Synchronizing Circuit Fundamentals; Deflecting Systems; Typical Television Receiver—Analysis and Alignment; Color Television; Frequency Modulation; Servicing Television Receivers; Glossary of Television Terms.

### EXAMINE THIS BOOK FREE

Let this great book prepare you to take advantage of the brilliant opportunities television offers. Send for it NOW!!

### MAIL THIS COUPON

D. VAN NOSTRAND COMPANY, INC.  
250 Fourth Avenue, New York 3, New York  
Please send me "Television Simplified." Within 10 days I will either return the book or send you \$4.75, plus a few cents postage. (If you enclose check or money order for \$4.75 with this coupon we will pay the postage. Same return privilege, and refund is guaranteed.)

Name.....  
Address.....  
City..... State.....  
Radio Craft Nov. 45



# ALL UNGAR TIPS

...are sure winners!



Yes, when you require speedy precision on intricate hard-to-reach jobs, you'll find a tip to fit the Ungar soldering pencil that will bring success. The ruggedly built Ungar soldering tool weighs only 3.6 ounces, is perfectly balanced and handles like a fountain pen. Length, 7 inches...heats in 90 seconds, draws only 17 watts and can take plenty punishment. Unit complete with any one tip sells for less than \$2. Please order from your nearest Electronics distributor.

No. 538 Chisel Tip, made from Elkaloy A, Tip  $\frac{1}{8}$ " dia.



No. 537 Pencil Tip, made from Elkaloy A, Tip  $\frac{1}{8}$ " dia.

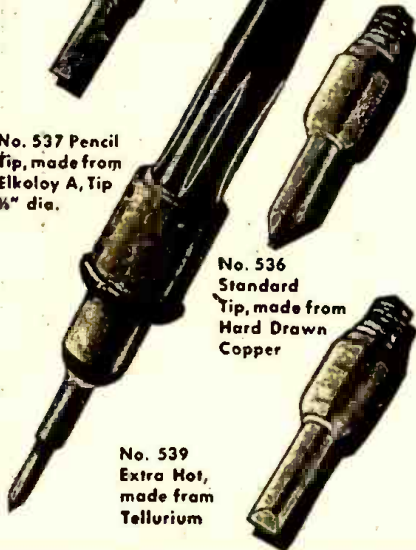

No. 536 Standard Tip, made from Hard Drawn Copper

No. 539 Extra Hot, made from Tellurium



# Ungar

Electric Tools, Inc.  
Formerly Harry A. Ungar, Inc.  
LOS ANGELES 54, CALIF.

## RADAR INDICATORS

(Continued from page 95)

right and to the left of the line. This is shown in figure 2B. This description applies to one type of airborne sea search radar only. There are several variations.

Figure 2C shows the "B" scope type of indication. In this type, the sweep line moves back and forth across the face of the scope, "painting" a somewhat peculiar "picture" on the screen. This picture is a distorted sort of a map. It is actually, however, a graphical presentation of the target's position of range against azimuth. Some radar sets which have been used by night fighters have another similar scope, called the "C" scope, which presents graphically the relative elevation of the target in degrees against the azimuth to the target in degrees. A "B" scope or an "A" scope is also required for such an installation in order that range may be determined. Basic control of the pictures for the "B" and "C" scopes is attained by mechanically coupling potentiometers to the antenna spinner.

The most widely used and popular scope is that known as the "PPI", or "Plan Position Indicator." This indicator, shown in Fig. 2D, literally gives a radar map of the surrounding area. Coastline, islands, ships, aircraft, lakes, rivers, bridges, cities, mountains, valleys, all show up in such a manner as to be read readily and accurately with little experience. For all indicators of "B", "C", and "PPI" types, the target is presented as a bright spot of light on the scope.

Rather than being a "V" on the time base or sweep line, it appears as a brighter spot than the rest. The luminous material on the scope face is of such material that the spot remains in view for several seconds. It is repainted continuously by the sweep line, so that it appears as a complete picture at any moment. On the PPI scope, the sweep line is a radial line, like the spoke of a wheel, which rotates about once every three seconds. This effect is obtained by sweeping from the center outward, and using an electromagnetic deflection type of cathode ray tube. The electromagnetic coils rotate about the neck of the tube in synchronization with the antenna which sweeps about, usually a full 360 degrees. If it is desirable to sweep only a small area, this is also possible, as shown in Fig. 3C.

Water areas show up as dark areas on the scope face for the "B", "C", and "PPI" type indicators. This is caused by the radar pulses being reflected off the relatively smooth surface of the water in the same manner that light-rays are reflected off a mirror, at an angle, and not returning to the source. The relatively rough areas send back reflections, the strength depending upon the roughness and also the reflective ability of the material.

Targets on land are more difficult to distinguish, but cities send back stronger signals than the surrounding terrain, as do mountains. "Shadows" back of mountains,

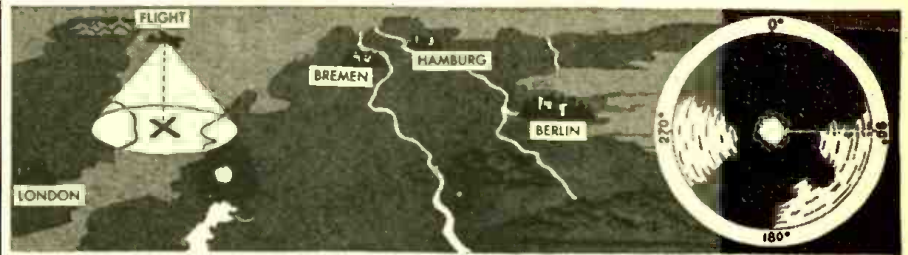

FLIGHT SHOWN STARTING FROM ENGLAND TOWARD TARGET (BERLIN). X SHOWS LOCATION OF FLIGHT OVER CHANNEL.

APPEARANCE OF PPI ON 50 MILE RANGE. BRIGHT LINE SHOWS HEADING OF 90°

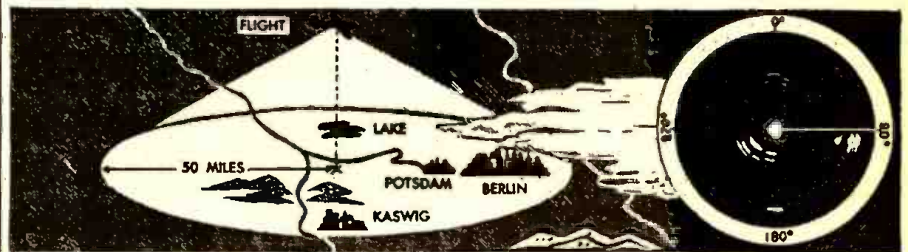

40 MILES FROM TARGET (BERLIN). NAVIGATOR MUST STUDY MAP TO LOCATE AREA BY TOPOGRAPHIC FEATURES.

PPI WITH 50 MILE RADIUS. BERLIN IS BRIGHT SPOT AT 40 MILES AND 100°. POTSDAM IS SMALL SPOT AT 30 MILES AND 100°. LAKE AT 25 MILES AND 0°. SHOWS AS DARK SPOT.



25 MILES FROM TARGET. SECTOR SCAN IN OPERATION, AIRCRAFT HEADING IS NOW 100°.

10 MILE RANGE CIRCLES ON 50 MILE PPI SCALE SHOW BERLIN AT 25 MILES.

Fig. 3—A (top) and B (center) are plan position indicators. C (bottom) is a sector scanner.



cliffs, etc., give no return and the black areas are sometimes mistaken for lakes by the inexperienced operators. "A", "B", and "C" scopes generally show the calibrations by means of gridded transparent plastic overlays which cover the face of the scope. The PPI scope, however, is provided with a circular metal ring which shows the azimuth around the face of the scope with the other indications, giving direct readings. The range circles show up as light rings. It is also possible to place directly into the

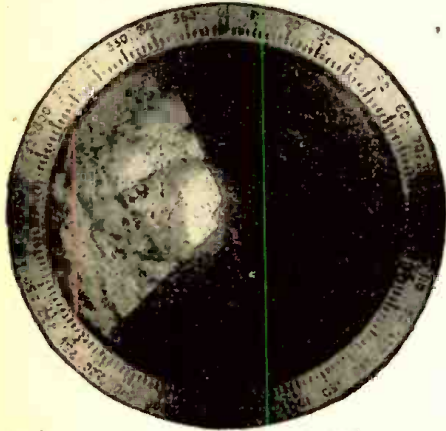

Sector scanning. Image is rough hill country; light areas are mountains and dark, valleys.

picture on the scope the bomb release circle and heading line which intersect at the center or the target for "Bombs Away!" when the set is used for bombing.

"IFF" (Identification, Friend or Foe) signals, which determine which of the ships or airplanes are friendly show up as an increase in amplitude of the "V" at intervals, and given codes. For other types the signal shows up as periodic or coded increases in brilliance of the target.

Recent press releases showed the outline of an airplane on a radar set, dark against the light signals. This was not a typical radar indication, but was rather a phenomenon, a radar shadow caused by a plane close below the radar set. Had this been a real radar indication, for the range to which the set was adjusted, the airplane would have had a wingspread of about 20 miles!

The narrower or sharper the antenna pattern, or beam, the greater the definition of the picture obtained on the radar scope. As the frequency is increased and sharper beams made possible by more efficient antenna arrays, the more useful the set becomes, because greater definition gives greater accuracy and greater ability to distinguish targets.

At present this subject cannot be discussed in more than general terms. In the near future, however, it may be possible to reveal more of the details of operation.



## Civilian RADIO JOBS Wanted

# FREE WANT-AD SERVICE

By Former Soldiers, Sailors, Marines

Radio-Craft offers its help-wanted columns free for the use of honorably discharged men in the armed services. State the type of position you seek, preferred locality, your experience, education, and other details. Confine ad to 50 words, or less. Supply name and address. Army veterans send section number or photostat of discharge paper. Navy men send photostat of discharge paper. Address RADIO-CRAFT, Classified Ad, Dept. 25, West Broadway, New York 7, N. Y. Your ad will contain a box number and replies will be forwarded to you.

### AVAILABLE

**SALES ENGINEER**—Electronic applications in industry; equipment design; industrial sales and engineering; drafting; test and repair experience. C. H., 109 Oley, Reading, Pa.

**RESPONSIBLE MAN**—28; seeks position with future; advancement; Profer Plastics and television field, but will consider any reasonable offers. Sol Greenbaum, 803 Rogers Pl., Bronx 59.

**WRITER**—8 years experience trade papers, newspapers, magazines; electronics; mechanics; adaptable all writing fields; college; married; 25, S. Refowich, 1331 Rosedale Ave., Bronx 60. Tel. 2-0207, evenings.

**EX NAVY**—Radio Technician with civilian technical electronics training. Now attending new engineering course at night (5 years). 3 years experience in laboratory, electronics work. Wishes position in lab with good future or something similar. Also experienced with machines, all tools. Drafting blueprints, etc. Winner of 4 year state scholarship. Arthur Ginsberg, 1454 Grand Concourse, Bronx 57, N.Y.C.

**RADIO ENGINEER**—FM and AM experience. Broadcast transmitter and studio maintenance and installation to 20 KW. Extensive FM installation and service fixed and mobile units. Considerable design of electronic devices, amplifiers, remote control units, time delay relays and control systems. University graduate, age 35. Prefer locality within 300 miles Chicago. Hudson C. Marhoff, R. 3, Box 128, Racine, Wisconsin.

**RADIO LAB. Assistant**. 20; radio-telegraph license, 2d cl.; deep pos. in radio-electronics, anxious to learn. T. Stern, 841 W. 177th St., N. Y. 33; EN 2-0968.

**RADIO MECHANIC**—desires position with radio or electronic concern. Radio-television training background, with some exp. repair commercial receivers. Salvatore J. Mondello, 1855 67 St., Brooklyn 4, N. Y.

**RADIO ENGINEER**—thoroughly experienced in receiver design, desires position as consultant for Western territory for Eastern radio manufacturer. Either full or part time. Member IRE, holds first class radio telephone license. Radio background dating to 1920. Classified by army, Radio Engineer I-R. Seileck, 6730 4th Ave., Los Angeles, California.

**ELECTRONICS TECHNICIAN**—B.S. degree, 3 yrs. educ. exp. radar and electronics; laboratory electronics instructor; desires pos. with future selling or technical. Albert Stockman, 2020 Walton Ave., N. Y. 53; SEdwick 3-0208.

**RADAR MECHANIC**—4 yrs. exp., capable using test equipment, oscilloscope, all meters, etc.; familiar with schematics; seeks pos. electronic field. Arthur Sacks, 551 Legion St., Bklyn 12, Dickens 2-0983.

**RADIO TECHNICIAN**—with radio and television diploma, seeks position in trouble shooting and servicing. Albert Hyman, Box 1101, % Radio-Craft, 25 West Broadway, New York 7, N. Y.

**RADAR Trouble Shooter and Tester**: exp. 2 years. would like to advance in radio-television electronics field, ambientous. Sigmund Fishman, 1214 Ave. 1, Brooklyn 30.

**RADIO**—Ex-P.O.W., married, former radio operator A.A.F., speak, write Spanish fluently; desires job in radio factory, agreeable, willing to learn. Frank F. Peroz, 1883 So. Blvd., N. Y. 60.

**RADIO**—service and repair, married, 23, 3 year's army experience in radar and electronics. Desiro position with future. Seymour Rosenthal, 1785 Longfellow Ave., Bronx 60, N. Y. Call after 6:30 p.m. Dayton 9-3946.

**ELECTRICIAN**—27; general and maintenance; ex-navy chief, 8 yrs. exp., int. stage electronic control, permanent pos. with future desired. W. L. Gardella, 20 Cornish St., Staten Island 8, N. Y. HO 6-0589.

**PARTS?**  
ORDER TODAY FROM...

**R. W. T.**  
**WORLD'S LARGEST**  
Radio Supply House • Founded 1922

For Industrial Organizations  
Laboratories • Purchasing Agents  
Radio Dealers & Service Men  
Training Schools • Expeditors  
Amateur Operators and Experimenters

**10,000 PARTS**  
Immediately available. (Some no longer  
need priorities.) Selected and shipped  
same day your order is received.

**Radio Wire**  
**Television Inc.**  
100 SIXTH AVE. (DEPT. A-11) NEW YORK 13  
BOSTON, MASS. NEWARK, N. J.

Originators of the  
**Lafayette Radio**  
soon in production again



## Unusual Buy Cathode-Ray Tubes



New, Factory sealed, for  
**TELEVISION & OSCILLOSCOPES**  
**RCA 5BP4 price . . . \$18.00**  
**DUMONT 5BP1 . . . \$15.00**  
**N-U 3AP1 price . . . \$9.00**  
**Other CR Tubes 3" to 12"**  
**Amphenol Coaxial Cables**

Polystyrene beaded & Polyethylene, solid dielectric for low losses and freedom from interference.  
 Type 21B-290-7/26-XXV, 72 ohm. List price \$0.86, your price \$0.25 p. ft. Many other types. Ask for list.

### TELEVISION PARTS

RCA Deflection yokes compl. with hardware & cable . . . \$19.50  
 RCA High and Low Voltage complete in one unit Television power supplies, oversize unit . . . \$90.00  
 Andrea Complete 5" Television Sets . . . \$189.50  
 Dumont Wide Band Oscilloscope, Type 248 . . . \$458.00  
 All types of ceramic, mica and oil CAPACITORS. Many other television parts. Write for complete catalog.

**RCA** Parts and Equipment  
 Distributors  
 WORLD'S FIRST  
 SPECIALIZED HOUSE IN TELEVISION  
**ELECTRONICS SERVICE & SUPPLY**  
 Dept. RC, 264 W. 40th St., New York 18, N. Y.

## KELNOR

REG. U. S. PAT. OFF.  
**electric SOLDERING IRONS**

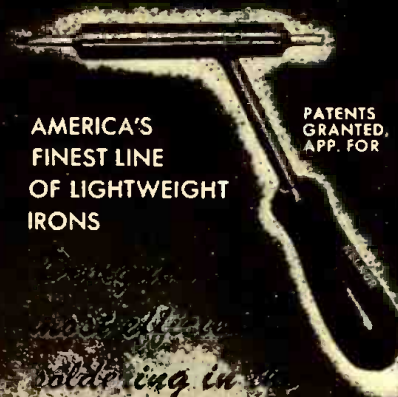

AMERICA'S  
 FINEST LINE  
 OF LIGHTWEIGHT  
 IRONS

PATENTS  
 GRANTED,  
 APP. FOR

*Soldering in*  
**ELECTRONIC  
 RADIO AND  
 INSTRUMENT  
 manufacturing and  
 repairing fields**

Easily solders hard-to-reach connections. Cuts down fatigue, increases accuracy. Illustration above about one-third actual size; weighs 9 ounces. Order from your retailer or jobber.

**KELNOR MANUFACTURING COMPANY**  
 GENERAL OFFICES: CENTRAL TOWER, SAN FRANCISCO 3, CALIF.

## EXPLORER ALL-WAVE RECEIVER

(Continued from page 96)

condensers. They are both operated by the band-spread vernier dial on the front panel. The large condenser (C12) is insulated from the U.H.F. tuner (C11) by a plastic drawer knob. They are insulated from the chassis by plastic supports.

The radio-frequency amplifier steps-up the feeble electric impulses received from the aerial before they reach the detector. The untuned amplifier stabilizes the action of the detector and provides a means for controlling the gain and selectivity. The R.F. gain control (R9) varies the strength of the R.F. energy reaching the amplifier and also controls the bias of the variable mu amplifier tube. No shielding of the R.F. amplifier will be necessary.

### PLUG-IN COIL DATA

The plug-in coils are classified as type "S" and "U." The "S" coils tune 665 to 10 meters using the R.F. amplifier. The "U" coils tune 10 to 4½ meters with the R.F. amplifier disconnected. The coils are assigned a second letter to indicate the style of winding used, and also a numeral to reveal the "U" or "S" band covered by the coil.

The grid coil of S-D-7 is wound with four layers of wire. After the first layer has been wound on the coil form, it is doped and covered by a paper strip which is wrapped tightly in place. The next layer is wound on this paper so that it ends di-

rectly over the place where the preceding layer starts. The third and fourth layers are wound similarly. It is important to have an insulating paper between each layer. The plate coil is wound in the same manner at the other end of the coil form, but has only three layers. Plug-in coil S-C-6 is wound in the same manner. The grid coil and plate coil have two layers each.

The grid coil of S-B-5 consists of a single layer of wire. The plate coil is wound upon an insulating paper that is wrapped tightly around the grid coil.

The four coils S-A-4 through S-A-1 are ordinary single-layer wound coils. S-A-1 and S-A-2 can be wound on 5-prong tube bases.

The "U" coils listed in the Plug-in Coil Data Table will not have a continuous range from 4½ to 10 meters; but the additional coils required can easily be constructed. The coils are connected to the receiver by means of a three-terminal strip mounted on an adapter unit which is plugged into the coil socket. The R.F. choke, mounted in the adaptor base, consists of about 20 turns of number 28 D.S.C. wire wound upon a ¼-inch wooden dowel. The coil and dowel should be carefully doped.

The data given in the Coil Table is only approximate; minor adjustments may have to be made with some coils. The plate windings should have just enough turns to

### PLUG-IN COIL DATA TABLE

All windings wound in same direction.  
 All "S" series coils on 1½-inch forms.

COIL	PLATE WINDING	GRID WINDING	"S"-"U" switch position	Approximate Wavelength
S-D-7	60 turns close No. 28 wire	250 turns close No. 28 wire	"S"	665-425 meters (451-700 kc)
S-C-6	40 turns close No. 28 wire	140 turns close No. 28 wire	"S"	500-275 meters (600-1100 kc)
S-B-5	6 turns close No. 28 wire	60 turns close No. 28 wire	"S"	300-140 meters (1000-2200 kc)
S-A-4	10 turns close No. 28 wire	29 turns close No. 26 wire	"S"	150-80 meters
S-A-3	8¾ turns close No. 26 wire	13 turns close No. 26 wire	"S"	80-40 meters
S-A-2	3¾ turns close No. 28 wire	6¼ turns spaced No. 26 wire	"S"	45-19 meters
S-A-1	4¾ turns close No. 28 wire	2¼ turns spaced No. 26 wire	"S"	20-10 meters
U-U-8	10 turns, ½ inch inside diam. Self-supporting coil, center tapped.		"U"	8 meters
U-V-6	2½ turns, 1½ inch diam. Self-supporting coil, center tapped.		"U"	6 meters
U-V-5	¾ turn, 2 inches tall. Self-supporting wire, center tapped.		"U"	5 meters
U-V-4½	½ turn, 1¼ inch tall. Self-supporting wire, center tapped.		"U"	4½ meters



cause the detector to oscillate over the entire dial. If too many turns are used, the detector will not be sensitive. "U" type coils should be tested with the tap at several different turns so as to insure best results.

### OPERATING POINTERS

The controls which are operated from the front panel will be found to respond similarly for every coil if the "U", "S" switch, the R.F. gain control, and the trimmer condenser are set so that the proper conditions for the coil being used are created. The volume control should be turned all the way up to receive distant stations. The regeneration control is advanced clockwise from zero until the detector goes into oscillation. When a station is tuned in, a beat frequency squeal or whistle will be heard. The detector is left in oscillation for reception of code signals; but when modulated phone stations are heard, the control should be reduced so that the sensitive point just before the detector starts to oscillate is reached.

When coils S-D-7 through S-A-4 are used, the R.F. gain control is adjusted so that the sliding contact arm is near the terminal marked "L" on the diagram. This reduces the R.F. gain sufficiently to bring in local and distant stations with good tone quality and high selectivity. Broadcast stations of several hundred miles distance can be received with a long aerial.

When coils S-A-3 through S-A-1 are used, the R.F. gain control is set so that the arm touches terminal "H." This allows the amplifier to operate normally. Although coil S-A-1 may not oscillate over the entire dial, it should tune from about 10 to 20 meters. Stations from all over the world can be received regularly.

The trimmer condenser (C16) couples the aerial to the U.H.F. type "U" coils. The R.F. gain control should be set to "H" position while the trimmer is being adjusted. If the trimmer is adjusted too tightly, the detector will become unstable or refuse to regenerate. Minor adjustments can be made with the R.F. control. Although the range of this regenerative U.H.F. de-

tor is limited to local reception; police, F.M., television sound, and many other interesting stations can be tuned-in.

The author believes this receiver to be a very interesting and instructive project for the radio experimenter. It was developed over a period of more than one year. During this time it picked up Africa, Australia, China, England, Japan, and many other stations regularly.

### Parts List

#### CONDENSERS

- C1, C2—20-20 mfd. 150 v. electrolytic condenser
- C3—.05 mfd. tubular condenser
- C4—5 mfd. 35 v. condenser
- C5—.005 mfd. tubular condenser
- C6—.02 mfd. tubular condenser
- C7—.01 mfd. tubular condenser
- C8—5 mfd. 200 v. condenser
- C9, C13—.0001 mfd. mica condenser
- C10—.00025 mfd. mica condenser
- C11—U.H.F. tuning condenser (15 mmf.)
- C12—140 mmf. tuning condenser
- C14, C15—.06 mfd. tubular condenser
- C16—3-30 mmf. trimmer condenser

#### RESISTORS

- 1—40 or 50 watt 120 v. cylindrical light bulb, or one 250 ohm 25 watt power resistor
- R1—3000 ohm 10 watt Sprague "KOLOHM" resistor
- R2—200 ohm carbon resistor
- R3—500,000 ohm potentiometer with fixed center tap and switch
- R4—200,000 ohm carbon resistor
- R5—15,000 ohm carbon resistor
- R6—50,000 ohm potentiometer
- R7—250,000 ohm carbon resistor
- R8—400 ohm carbon resistor
- R9—20,000 ohm potentiometer

#### TUBES

- 1—32L7-GT radio tube
- 1—6C8-G radio tube
- 1—6K7 radio tube

#### MISCELLANEOUS ITEMS

- T1—4 or 5 inch P.M. speaker with output transformer; primary resistance should be 2,600 ohms
- T2—3:1 good quality audio transformer
- 1—Large size flashlight battery (1½ volts)
- 1—2 post terminal for key leads
- 1—3 post terminal
- 2—tie point strips
- 1—S.P.D.T. switch or one single jack and two cord tips
- 3—Octal "MIP" sockets
- 1—5 prong "MIP" socket
- 1—Edison lamp socket for light bulb
- R.F.C.1—2.5 mh. R.F. choke
- R.F.C.2—U.H.F. choke (see text)
- 8—5 prong coil forms
- 1—Vernier dial
- 3—Pointer knobs
- 1—Chassis (9 x 6 x 2 inches) with front panel
- 1—Power cord with plug
- Nuts and screws, wire, grid caps, etc.

### RADIO TERM ILLUSTRATED

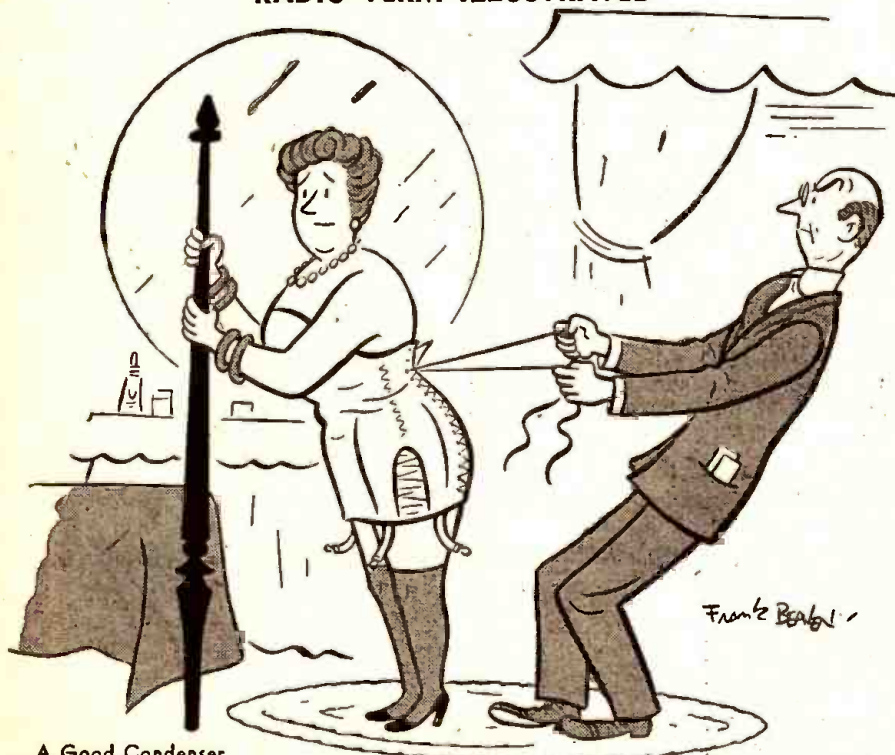

A Good Condenser

Suggested by: Howard Howell, Dillon, S. C.

### New Direct-Coupled FM - AM

## AMPLIFIER MANUAL

By A. C. SHANEY

Chief Engineer, Amplifier Co. of America

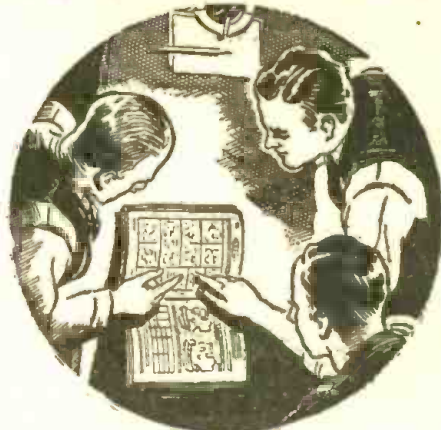

### For the Layman, Serviceman, Recordist and Engineer

Regardless of whether you are interested in the finest type of phonograph reproduction, high fidelity recording, sound-on-film applications, FM or AM programs, you will find invaluable information in this practical handbook. Written by the leading exponent of direct-coupled amplifiers who has spent more than 10 years improving and perfecting the famous Loftin-White circuit.

### Explains the theory and practical application of:

- Variable Speed Non-Overloading Push-Pull Expansion
- Non-Frequency Discriminating Scratch Suppression
- Push-Pull Balanced Direct-Coupled Amplification
- Push-Pull High-Frequency Equalization
- Push-Pull Low-Frequency Equalization
- Push-Pull Volume Compression
- Automatic Volume Limitation
- Automatic Volume Control
- Calibrated V. U. Indicator
- Audio Spectrum Control
- Remote Control

If you are interested in the latest audio developments, you can't afford to be without this complete compilation of authentic articles on Direct-Coupled Amplifiers. 32 pages 8½" x 11". Over 100 diagrams and illustrations.

Priced to Cover Cost of 25c  
Printing and Mailing

Send U. S. Stamps or Coin

### AMPLIFIER CO. of AMERICA

396 BROADWAY NEW YORK, N. Y.

## Learn RADIO-ELECTRONICS-TELEVISION

12 WEEKS

TRAINING IN COYNE

SHOPS WHERE YOU

"LEARN-BY-DOING"

Trained Radio-Electronics men needed now. They will be needed too when the war is over. Tremendous expansion in Radio, Electronics, Frequency Modulation and Television predicted—a world of new opportunities. Get Radio Training in the Coyne Shops in Chicago now, and BE READY.

### Ill Finance Your Training

If you are short of money, you can start now and pay most of your tuition after you graduate. Many earn while learning. Free Lifetime Employment Service to graduates. EXTRA training in INDUSTRIAL ELECTRONICS and Electric Refrigeration—no extra cost.

### FREE BOOK

Whether you're 16 or up to 40, get the facts. Big illustrated book tells about your future in Radio-Electronics-Television. Mail coupon today. We also have facilities for men with physical disabilities whether due to war or other causes. Check coupon for details.

VETERANS Coyne is equipped to train those who qualify for training under the G. I. Bill of Rights. Check coupon.

H. C. LEWIS, Pres., RADIO-ELECTRONICS DIVISION, COYNE ELECTRICAL SCHOOL, 500 S. Paulina St., Dept. 85-8M, Chicago 12, Illinois

Send me FREE BOOK on COYNE RADIO-ELECTRONICS TRAINING and details of "Pay-After-Graduation" Plan.  Send physical disability details.  Send special G. I. Bulletin.

NAME .....

ADDRESS .....

CITY .....

STATE .....



## Beautiful WALNUT CABINETS



Model M-1 CUT TO FIT MEISSNER  
6 TUBE KIT 10-1199 YOUR COST \$3.95

Model C-13" L 7 1/2" H 7 1/2" D Blank.... 3.95  
Model B-12" L 7 1/2" H 6 1/2" D Blank.... 3.75  
Model A-11" L 7" H 6" D Blank..... 3.25  
Model AA 10" L 7" H 5 1/2" D Blank.... 2.95  
Model AAA 9" L 6" H 4 1/2" D Blank.... 2.45  
Model V-Phono 12x11x4" Blank..... 3.25

We can also furnish all types of Radio and electronic equipment.

MC GEE RADIO & ELECTRIC CO.  
1330 Broadway Denver, Colorado

## YOUR NEW FREE CATALOG IS READY FOR YOU!

Radionic's Catalog No. 26 lists hard-to-get radio parts! Helps you fill your radio and electronic needs. All parts are available for immediate shipment. All are highest quality. All are exceptional values.

SEND TODAY FOR YOUR FREE COPY TO Dept. 112

RADIONIC EQUIPMENT CO.,  
"CHANCELLOR" PRODUCTS  
170 NASSAU STREET, NEW YORK 7, N. Y.

## Get Started in Radio



### 10 "HOW-TO-DO-IT" BOOKS

Get a solid foundation in radio by means of these 10 timely text books. Each clearly written, profusely illustrated, contains over 15,000 words. You'll be amazed at the wealth of information packed into these handy books. Excellent for reference—ideal for technical library. Your money back if not satisfied.

10¢ each 5 for 50¢ 10 for \$1.00  
PREPAID  
WE CANNOT FILL ORDERS FOR LESS THAN 5 BOOKS

- |                                                                    |                                     |
|--------------------------------------------------------------------|-------------------------------------|
| No. 1—How To Make Four Doodle Short Wave Sets                      | No. 6—How To Have Fun With Radio    |
| No. 2—How To Make The Most Popular All-Wave 1 and 2 Tube Receivers | No. 7—How To Read Radio Diagrams    |
| No. 3—Alternating Current for Beginners                            | No. 8—Radio for Beginners           |
| No. 4—All About Aerials                                            | No. 9—Simple Electrical Experiments |
| No. 5—Beginners' Radio Dictionary                                  | No. 10—Television                   |
- Remit by check or money order—register letter if you rec'd. cash or stamps.
- RADIO PUBLICATIONS, 25C West B'way, New York (7)

## Do you need BINDING POSTS?



The XL PUSH POST with its Spring Action assures Constant Contact and Quick connection.  
Manufactured in All Aluminum Type M at 12¢ each.  
Aluminum Body, Bakelite Top Type B1 at 15¢ each.  
Types CP or NP. ALL BRASS—STAINLESS STEEL SPRING & PIN. PROVEN BY 240 HR. SALT SPRAY TEST as NON-CORROSIVE at 28¢ each.  
Manufacturers and Dealers Liberal Discounts

X. L. RADIO LABORATORIES  
420 West Chicago Ave., Chicago 10, Ill.

## MAGIC & CARD TRICKS



How to Perform for Fun & Money  
Mystifying stunts made easy. Secrets of magic revealed in this new illustrated course. Teaches tricks with handkerchiefs, coins, balls, ropes, etc. Shows you how to protect yourself from card sharks... their card manipulations exposed! Get "inside" information on betting stage performances. Learn how to be a magician and entertain friends. LOW PRICE. Money-back guarantee. Write today for Free details and big Success Catalog. No obligation.

NELSON Co., 321 S. Wabash Av., Dept. 1139, Chicago 4, Ill.

## BOAT RADIO INSTALLATIONS

(Continued from previous page)

remaining two wires, and finally the remaining end is wrapped around the antenna wire. This gives a neat, strong tie for the antenna. A good method of connecting the lead-in is shown in Fig. 4.

If the boat is not equipped with a ground plate it will be necessary to put it on the ways for this operation. This plate should consist of from 10 to 20 square feet of copper, screwed to the hull where it will be in the water at all times. Brass screws about every two inches along the edge of the plate will secure it to the hull and prevent the edge from catching on underwater obstacles. One or two brass bolts should be soldered to the plate and extended into the bilge for making connection to the plate. It is well when mounting the plate to first coat it with red or white lead on the side next to the hull. This will prevent water from seeping in between the plate and hull. Since the plate is the ground connection it should not be painted.

### CHECKING THE INSTALLATION

We now come to the most difficult part of the work. Assuming the antenna leads the transmitter satisfactorily and the receiver operates properly we may make a few contacts to satisfy ourselves that the equipment is doing all that can be expected of it with the boat at dock. The final test however, is whether satisfactory commu-

nication can be carried on while under way. With the boat cruising at normal speed we may imagine we have undertaken an impossible task. Noise from the engines and the electrical equipment blankets all but the loudest signals. The degree to which this noise is eliminated determines which of the servicemen will continue to be called on for this type of work.

To run down the noise which will be present in almost all but the newest boats it is best to shut down everything and start up all of the noise producers one at a time, noting which cause noise and which cause none. Most of the noise, excluding the main engines, will be from blowers, windshield wipers, pump motors, fluorescent lights, and the like. The usual suppression methods should be applied to all possible noise sources. As motors and other devices collect dirt and the commutator and brushes wear, noise increases. If all these possible sources of noise are treated just as though they were bad we may save future call-backs.

On boats where the equipment is mounted close to or above the main engines the mechanical noise may be sufficient to prevent satisfactory reception. This may sometimes be greatly reduced by the application of sound-absorbing fiberboard to the walls or floor separating the engines from the radio room.

## SUPPRESSOR CIRCUIT

The suppressor circuit shown is applied in a slightly different way than usual to a radio. It is useful in suppressing static or blasting, or can be applied to a combination radio, phonograph and recorder to prevent overmodulating the recording blank.

Some of the audio output of the set is rectified and the resulting direct current applied to the automatic volume circuit in the set as an added source of control bias.

The action may be controlled by the variable resistor connected through the 250,000-ohm resistor to the B+ supply. Rectification occurs in the diode circuit when the plate is positive with respect to the cathode. This action is not reversible within the tube ratings, as the plates are not electron-emitting surfaces. Thus if the cathodes are maintained at a positive D.C. potential above any positive value on the plates, no current will flow and no suppression is effected.

If the plates are more positive than the cathodes on voltage peaks, rectification will occur on these peaks. Current then flows through the corresponding half of the center-tapped transformer through the filter and AVC resistances and back through the tube. The resistance of the filter is low compared to most AVC resistances; thus most of the voltage developed is supplied at point X in the diagram. Since the transformer center tap is negative with respect to ground, voltage at X is negative and will decrease the gain of the tubes to which it is applied.

Usually the desired effect is to suppress static or transients, characterized by sharp wave-fronts and high instantaneous peak voltages. Sufficient bias may be maintained on the diode to prevent interference with ordinary reception.

If the suppressor is properly adjusted, the click heard in the radio accompanying electrical switching is absent. Sustained

electrical interference will greatly decrease the volume of the reception. Severe instantaneous electrical disturbances produce a short period of silence, the length of the period determined by the time constant of resistance and capacitance of the filter and AVC circuit. The expression for this is  $T = RC$ , R in megohms and C in microfarads, the time being in seconds, assuming perfect or nearly perfect condensers.

A universal push-pull output transformer is useful in adjusting the action of the suppressor. Lacking this the action may be adjusted by changing values of the 250,000-ohm resistor in series with the 250,000-ohm control to the B+, or by omitting the resistor and using a higher value of control. The values shown have been tried and proven. Suppressor action must be confined to remote cut-off tubes or serious distortion will occur.—Carl Lewis

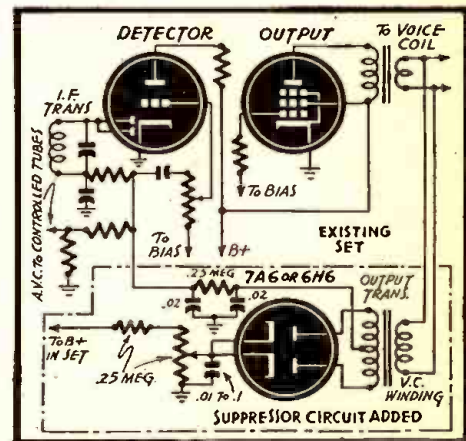



cause the detector to oscillate over the entire dial. If too many turns are used, the detector will not be sensitive. "U" type coils should be tested with the tap at several different turns so as to insure best results.

### OPERATING POINTERS

The controls which are operated from the front panel will be found to respond similarly for every coil if the "U"-S" switch, the R.F. gain control, and the trimmer condenser are set so that the proper conditions for the coil being used are created. The volume control should be turned all the way up to receive distant stations. The regeneration control is advanced clockwise from zero until the detector goes into oscillation. When a station is tuned in, a beat frequency squeal or whistle will be heard. The detector is left in oscillation for reception of code signals; but when modulated phone stations are heard, the control should be reduced so that the sensitive point just before the detector starts to oscillate is reached.

When coils S-D-7 through S-A-4 are used, the R.F. gain control is adjusted so that the sliding contact arm is near the terminal marked "L" on the diagram. This reduces the R.F. gain sufficiently to bring in local and distant stations with good tone quality and high selectivity. Broadcast stations of several hundred miles distance can be received with a long aerial.

When coils S-A-3 through S-A-1 are used, the R.F. gain control is set so that the arm touches terminal "H." This allows the amplifier to operate normally. Although coil S-A-1 may not oscillate over the entire dial, it should tune from about 10 to 20 meters. Stations from all over the world can be received regularly.

The trimmer condenser (C16) couples the aerial to the U.H.F. type "U" coils. The R.F. gain control should be set to "H" position while the trimmer is being adjusted. If the trimmer is adjusted too tightly, the detector will become unstable or refuse to regenerate. Minor adjustments can be made with the R.F. control. Although the range of this regenerative U.H.F. de-

tor is limited to local reception; police, F.M., television sound, and many other interesting stations can be tuned-in.

The author believes this receiver to be a very interesting and instructive project for the radio experimenter. It was developed over a period of more than one year. During this time it picked up Africa, Australia, China, England, Japan, and many other stations regularly.

### Parts List

#### CONDENSERS

- C1, C2—20-20 mfd. 150 v. electrolytic condenser
- C3—.05 mfd. tubular condenser
- C4—5 mfd. 35 v. condenser
- C5—.005 mfd. tubular condenser
- C6—.02 mfd. tubular condenser
- C7—.01 mfd. tubular condenser
- C8—5 mfd. 200 v. condenser
- C9, C13—.0001 mfd. mica condenser
- C10—.00025 mfd. mica condenser
- C11—U.H.F. tuning condenser (15 mmf.)
- C12—140 mmf. tuning condenser
- C14, C15—.06 mfd. tubular condenser
- C16—3-30 mmf. trimmer condenser

#### RESISTORS

- 1—40 or 50 watt 120 v. cylindrical light bulb, or one 250 ohm 25 watt power resistor
- R1—3000 ohm 10 watt Sprague "KOLOHM" resistor
- R2—200 ohm carbon resistor
- R3—500,000 ohm potentiometer with fixed center tap and switch
- R4—200,000 ohm carbon resistor
- R5—15,000 ohm carbon resistor
- R6—50,000 ohm potentiometer
- R7—250,000 ohm carbon resistor
- R8—400 ohm carbon resistor
- R9—20,000 ohm potentiometer

#### TUBES

- 1—32L7-GT radio tube
- 1—6C8-G radio tube
- 1—6K7 radio tube

#### MISCELLANEOUS ITEMS

- T1—4 or 5 inch P.M. speaker with output transformer; primary resistance should be 2,600 ohms
- T2—3:1 good quality audio transformer
- 1—Large size flashlight battery (1½ volts)
- 1—2 post terminal for key leads
- 1—3 post terminal
- 2—tie point strips
- 1—S.P.D.T. switch or one single jack and two cord tips
- 3—Octal "MIP" sockets
- 1—5 prong "MIP" socket
- 1—Edison lamp socket for light bulb
- R.F.C.1—2.5 mh. R.F. choke
- R.F.C.2—U.H.F. choke (see text)
- 8—5 prong coil forms
- 1—Vernier dial
- 3—Pointer knobs
- 1—Chassis (9 x 6 x 2 inches) with front panel
- 1—Power cord with plug
- Nuts and screws, wire, grid caps, etc.

### RADIO TERM ILLUSTRATED

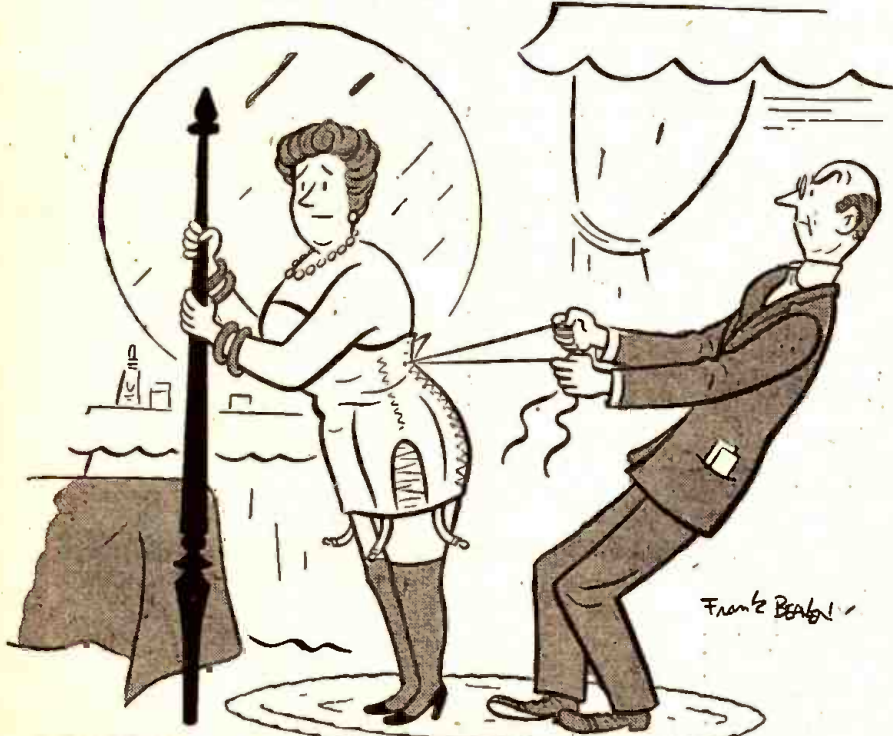

A Good Condenser

Suggested by: Howard Howell, Dillon, S. C.

## New Direct-Coupled FM - AM

# AMPLIFIER MANUAL

By A. C. SHANEY

Chief Engineer, Amplifier Co. of America



For the Layman, Serviceman  
Recordist and Engineer

Regardless of whether you are interested in the finest type of phonograph reproduction, high fidelity recording, sound-on-film applications, FM or AM programs, you will find invaluable information in this practical handbook. Written by the leading exponent of direct-coupled amplifiers who has spent more than 10 years improving and perfecting the famous Lottin-White circuit.

Explains the theory and practical application of:

- Variable Speed Non-Overloading Push-Pull Expansion
- Non-Frequency Discriminating Scratch Suppression
- Push-Pull Balanced Direct-Coupled Amplification
- Push-Pull High-Frequency Equalization
- Push-Pull Low-Frequency Equalization
- Push-Pull Volume Compression
- Automatic Volume Limitation
- Automatic Volume Control
- Calibrated V. U. Indicator
- Audio Spectrum Control
- Remote Control

If you are interested in the latest audio developments, you can't afford to be without this complete compilation of authentic articles on Direct-Coupled Amplifiers. 83 pages 8½ x 11". Over 100 diagrams and illustrations.

Priced to Cover Cost of 25c  
Printing and Mailing

Send U. S. Stamps or Coin

## AMPLIFIER CO. of AMERICA

396 BROADWAY NEW YORK, N. Y.

# Learn RADIO-ELECTRONICS-TELEVISION



12 WEEKS

TRAINING IN COYNE

SHOPS WHERE YOU "LEARN-BY-DOING"

Trained Radio-Electronics men needed now. They will be needed too when the war is over. Tremendous expansion in Radio, Electronics, Frequency Modulation and Television predicted — a world of new opportunities. Get Radio Training in the Coyne Shops in Chicago now, and BE READY.

### Ill Finance Your Training

If you are short of money, you can start now and pay most of your tuition after you graduate. Many earn while learning. Free Lifetime Employment Service to graduates. EXTRA training in INDUSTRIAL ELECTRONICS and Electric Refrigeration — no extra cost.

#### FREE BOOK

Whether you're 16 or up to 40, get the facts. Big illustrated book tells about your future in Radio-Electronics-Television. Mail coupon today. We also have facilities for men with physical disabilities whether due to war or other causes. Check coupon for details.

VETERANS Coyne is equipped to train those who qualify for training under the G. I. Bill of Rights. Check coupon.

H. C. LEWIS, Pres., RADIO-ELECTRONICS DIVISION, COYNE ELECTRICAL SCHOOL, 506 S. Paulina St., Dept. 85-84, Chicago 12, Illinois

Send me FREE BOOK on COYNE RADIO-ELECTRONICS TRAINING and details of "Pay-After-Graduation" Plan.  Send physical disability details.  Send special G. I. Bulletin.

NAME.....  
ADDRESS.....  
CITY.....STATE.....



## Beautiful WALNUT CABINETS

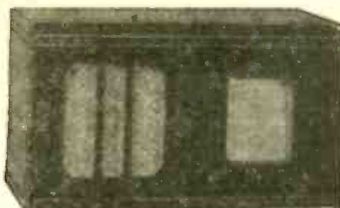

Model M-1 CUT TO FIT MEISSNER  
6 TUBE KIT 10-1199 YOUR COST \$3.95

Model C-13" L 7 1/2" H 7 1/2" D Blank.... 3.95  
Model B-12" L 7 1/2" H 6 1/2" D Blank.... 3.75  
Model A-11" L 7" H 6" D Blank..... 3.25  
Model AA 10" L 7" H 5 1/2" D Blank.... 2.95  
Model AAA 9" L 6" H 4 1/2" D Blank.... 2.45  
Model V-Phono 12x11x4" Blank..... 3.25

We can also furnish all types of Radio and electronic equipment.

MC GEE RADIO & ELECTRIC CO.  
1330 Broadway Denver, Colorado

**YOUR NEW FREE CATALOG IS READY FOR YOU!**

Radionic's Catalog No. 26 lists hard-to-get radio parts • Helps you fill your radio and electronic needs. • All parts are available for immediate shipment • All are highest quality. • All are exceptional values.

SEND TODAY FOR YOUR FREE COPY TO Dept. 118

RADIONIC EQUIPMENT CO.,  
"CHANCELLOR" PRODUCTS  
170 NASSAU STREET, NEW YORK 7, N. Y.

## Get Started in Radio



### 10 "HOW-TO-DO-IT" BOOKS

Get a solid foundation in radio by means of these 10c timely text books. Each clearly written, profusely illustrated, contains over 15,000 words. You'll be amazed at the wealth of information packed into these handy books. Excellent for reference—ideal for technical library. Your money back if not satisfied.

**10c each** 5 for 50c  
10 for \$1.00  
PREPAID

WE CANNOT FILL ORDERS FOR LESS THAN 5 BOOKS

- |                                                                    |                                     |
|--------------------------------------------------------------------|-------------------------------------|
| No. 1—How To Make Four Doodle Short Wave Sets                      | No. 6—How To Have Fun With Radio    |
| No. 2—How To Make The Most Popular All-Wave 1 and 2 Tube Receivers | No. 7—How To Read Radio Diagrams    |
| No. 3—Alternating Current for Beginners                            | No. 8—Radio for Beginners           |
| No. 4—All About Aerials                                            | No. 9—Simple Electrical Experiments |
| No. 5—Beginners' Radio Dic.                                        | No. 10—Television                   |

Remit by check or money order—register letter if you send cash or stamps.  
RADIO PUBLICATIONS, 25C West B'way, New York (7)

## Do you need BINDING POSTS?



The XL PUSH POST with its Spring Action assures Constant Contact and quick connection.  
Manufactured in All Aluminum Type M at 12c each.  
Aluminum Body, Bakelite Top Type B1 at 15c each.  
Types CP or NP. ALL BRASS—STAIN-LESS STEEL SPRING & PIN, PROVEN by 240 HR. SALT SPRAY TEST as NON-CORROSIVE at 28c each.  
Manufacturers and Dealers Liberal Discounts

X. L. RADIO LABORATORIES  
420 West Chicago Ave., Chicago 10, Ill.

## MAGIC & CARD TRICKS

How to Perform for Fun & Money  
Mystifying stunts made easy. Secrets of magic revealed in this new illustrated course. Teaches tricks with handkerchiefs, coins, balls, ropes, etc. Shows you how to protect yourself from card sharks... their card manipulations exposed! Get "inside" information on baffling stage performance. Learn how to be a magician and entertain your friends. LOW PRICE. Money-back guarantee. Write today for free details and big Success-Catalog! No obligation.  
NELSON Co., 321 S. Wabash Av., Dept. 1L39, Chicago 4, Ill.

## BOAT RADIO INSTALLATIONS

(Continued from previous page)

remaining two wires, and finally the remaining end is wrapped around the antenna wire. This gives a neat, strong tie for the antenna. A good method of connecting the lead-in is shown in Fig. 4.

If the boat is not equipped with a ground plate it will be necessary to put it on the ways for this operation. This plate should consist of from 10 to 20 square feet of copper, screwed to the hull where it will be in the water at all times. Brass screws about every two inches along the edge of the plate will secure it to the hull and prevent the edge from catching on underwater obstacles. One or two brass bolts should be soldered to the plate and extended into the bilge for making connection to the plate. It is well when mounting the plate to first coat it with red or white lead on the side next to the hull. This will prevent water from seeping in between the plate and hull. Since the plate is the ground connection it should not be painted.

### CHECKING THE INSTALLATION

We now come to the most difficult part of the work. Assuming the antenna loads the transmitter satisfactorily and the receiver operates properly we may make a few contacts to satisfy ourselves that the equipment is doing all that can be expected of it with the boat at dock. The final test however, is whether satisfactory commu-

nication can be carried on while under way. With the boat cruising at normal speed we may imagine we have undertaken an impossible task. Noise from the engines and the electrical equipment blankets all but the loudest signals. The degree to which this noise is eliminated determines which of the servicemen will continue to be called on for this type of work.

To run down the noise which will be present in almost all but the newest boats it is best to shut down everything and start up all of the noise producers one at a time, noting which cause noise and which cause none. Most of the noise, excluding the main engines, will be from blowers, windshield wipers, pump motors, fluorescent lights, and the like. The usual suppression methods should be applied to all possible noise sources. As motors and other devices collect dirt and the commutator and brushes wear, noise increases. If all these possible sources of noise are treated just as though they were bad we may save future call-backs.

On boats where the equipment is mounted close to or above the main engines the mechanical noise may be sufficient to prevent satisfactory reception. This may sometimes be greatly reduced by the application of sound-absorbing fiberboard to the walls or floor separating the engines from the radio room.

## SUPPRESSOR CIRCUIT

THE suppressor circuit shown is applied in a slightly different way than usual to a radio. It is useful in suppressing static or blasting, or can be applied to a combination radio, phonograph and recorder to prevent overmodulating the recording blank.

Some of the audio output of the set is rectified and the resulting direct current applied to the automatic volume circuit in the set as an added source of control bias.

The action may be controlled by the variable resistor connected through the 250,000-ohm resistor to the B+ supply. Rectification occurs in the diode circuit when the plate is positive with respect to the cathode. This action is not reversible within the tube ratings, as the plates are not electron-emitting surfaces. Thus if the cathodes are maintained at a positive D.C. potential above any positive value on the plates, no current will flow and no suppression is effected.

If the plates are more positive than the cathodes on voltage peaks, rectification will occur on these peaks. Current then flows through the corresponding half of the center-tapped transformer through the filter and AVC resistances and back through the tube. The resistance of the filter is low compared to most AVC resistances; thus most of the voltage developed is supplied at point X in the diagram. Since the transformer center tap is negative with respect to ground, voltage at X is negative and will decrease the gain of the tubes to which it is applied.

Usually the desired effect is to suppress static or transients, characterized by sharp wave-fronts and high instantaneous peak voltages. Sufficient bias may be maintained on the diode to prevent interference with ordinary reception.

If the suppressor is properly adjusted, the click heard in the radio accompanying electrical switching is absent. Sustained

electrical interference will greatly decrease the volume of the reception. Severe instantaneous electrical disturbances produce a short period of silence, the length of the period determined by the time constant of resistance and capacitance of the filter and AVC circuit. The expression for this is  $T = RC$ , R in megohms and C in microfarads, the time being in seconds, assuming perfect or nearly perfect condensers.

A universal push-pull output transformer is useful in adjusting the action of the suppressor. Lacking this the action may be adjusted by changing values of the 250,000-ohm resistor in series with the 250,000-ohm control to the B+, or by omitting the resistor and using a higher value of control. The values shown have been tried and proven. Suppressor action must be confined to remote cut-off tubes or serious distortion will occur.—Carl Lewis

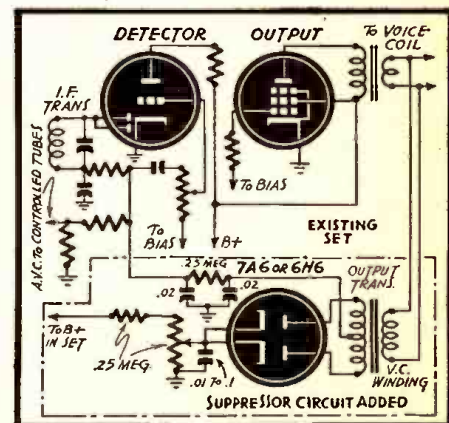

Signals from the voice coil, when they pass a critical voltage, start a current flow in the 6H6 circuit, which causes the AVC to become increasingly negative, reducing volume.



cause the detector to oscillate over the entire dial. If too many turns are used, the detector will not be sensitive. "U" type coils should be tested with the tap at several different turns so as to insure best results.

### OPERATING POINTERS

The controls which are operated from the front panel will be found to respond similarly for every coil if the "U"-S" switch, the R.F. gain control, and the trimmer condenser are set so that the proper conditions for the coil being used are created. The volume control should be turned all the way up to receive distant stations. The regeneration control is advanced clockwise from zero until the detector goes into oscillation. When a station is tuned in, a beat frequency squeal or whistle will be heard. The detector is left in oscillation for reception of code signals; but when modulated phone stations are heard, the control should be reduced so that the sensitive point just before the detector starts to oscillate is reached.

When coils S-D-7 through S-A-4 are used, the R.F. gain control is adjusted so that the sliding contact arm is near the terminal marked "L" on the diagram. This reduces the R.F. gain sufficiently to bring in local and distant stations with good tone quality and high selectivity. Broadcast stations of several hundred miles distance can be received with a long aerial.

When coils S-A-3 through S-A-1 are used, the R.F. gain control is set so that the arm touches terminal "H." This allows the amplifier to operate normally. Although coil S-A-1 may not oscillate over the entire dial, it should tune from about 10 to 20 meters. Stations from all over the world can be received regularly.

The trimmer condenser (C16) couples the aerial to the U.H.F. type "U" coils. The R.F. gain control should be set to "H" position while the trimmer is being adjusted. If the trimmer is adjusted too tightly, the detector will become unstable or refuse to regenerate. Minor adjustments can be made with the R.F. control. Although the range of this regenerative U.H.F. de-

tor is limited to local reception; police, F.M., television sound, and many other interesting stations can be tuned-in.

The author believes this receiver to be a very interesting and instructive project for the radio experimenter. It was developed over a period of more than one year. During this time it picked up Africa, Australia, China, England, Japan, and many other stations regularly.

### Parts List

#### CONDENSERS

- C1, C2—20-20 mfd. 150 v. electrolytic condenser
- C3—.05 mfd. tubular condenser
- C4—.5 mfd. 35 v. condenser
- C5—.005 mfd. tubular condenser
- C6—.02 mfd. tubular condenser
- C7—.01 mfd. tubular condenser
- C8—.5 mfd. 200 v. condenser
- C9, C13—.0001 mfd. mica condenser
- C10—.00025 mfd. mica condenser
- C11—U.H.F. tuning condenser (15 mmf.)
- C12—140 mmf. tuning condenser
- C14, C15—.06 mfd. tubular condenser
- C16—3-30 mmf. trimmer condenser

#### RESISTORS

- R1—40 or 50 watt 120 v. cylindrical light bulb, or one 250 ohm 25 watt power resistor
- R2—3000 ohm 10 watt Sprague "KOLOHM" resistor
- R3—200 ohm carbon resistor
- R4—500,000 ohm potentiometer with fixed center tap and switch
- R5—200,000 ohm carbon resistor
- R6—15,000 ohm carbon resistor
- R7—50,000 ohm potentiometer
- R8—250,000 ohm carbon resistor
- R9—400 ohm carbon resistor
- R10—20,000 ohm potentiometer

#### TUBES

- 1—32L7-GT radio tube
- 1—6C8-G radio tube
- 1—6K7 radio tube

#### MISCELLANEOUS ITEMS

- T1—4 or 5 inch P.M. speaker with output transformer; primary resistance should be 2,600 ohms
- T2—3:1 good quality audio transformer
- 1—Large size flashlight battery (1½ volts)
- 1—2 post terminal for key leads
- 1—3 post terminal
- 2—tie point strips
- 1—S.P.D.T. switch or one single jack and two cord tips
- 3—Octal "MIP" sockets
- 1—5 prong "MIP" socket
- 1—Edison lamp socket for light bulb
- R.F.C.1—2.5 mh. R.F. choke
- R.F.C.2—U.H.F. choke (see text)
- 3—5 prong coil forms
- 1—Vernier dial
- 3—Pointer knobs
- 1—Chassis (9 x 6 x 2 inches) with front panel
- 1—Power cord with plug
- Nuts and screws, wire, grid caps, etc.

### RADIO TERM ILLUSTRATED

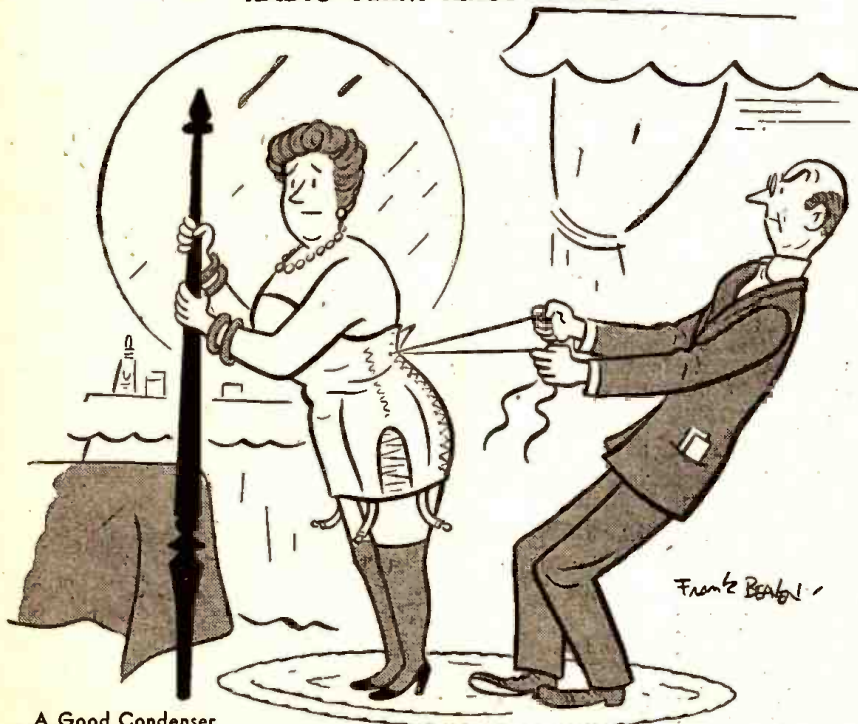

A Good Condenser

Suggested by: Howard Howell, Dillon, S. C.

### New Direct-Coupled FM - AM

# AMPLIFIER MANUAL

By A. C. SHANEY

Chief Engineer, Amplifier Co. of America



For the Layman, Serviceman  
Recordist and Engineer

Regardless of whether you are interested in the finest type of phonograph reproduction, high fidelity recording, sound-on-film applications, FM or AM programs, you will find invaluable information in this practical handbook. Written by the leading exponent of direct-coupled amplifiers who has spent more than 10 years improving and perfecting the famous Loftin-White circuit.

Explains the theory and practical application of:

- Variable Speed Non-Overloading Push-Pull Expansion
- Non-Frequency Discriminating Scratch Suppression
- Push-Pull Balanced Direct-Coupled Amplification
- Push-Pull High-Frequency Equalization
- Push-Pull Low-Frequency Equalization
- Push-Pull Volume Compression
- Automatic Volume Limitation
- Automatic Volume Control
- Calibrated V. U. Indicator
- Audio Spectrum Control
- Remote Control

If you are interested in the latest audio developments, you can't afford to be without this complete compilation of authentic articles on Direct-Coupled Amplifiers. 38 pages 8½" x 11". Over 100 diagrams and illustrations.

Priced to Cover Cost of 25c  
Printing and Mailing

Send U. S. Stamps or Coin

### AMPLIFIER CO. of AMERICA

396 BROADWAY

NEW YORK, N. Y.

# Learn RADIO-ELECTRONICS-TELEVISION



12 WEEKS

TRAINING IN COYNE

SHOPS WHERE YOU "LEARN-BY-DOING"

Trained Radio-Electronics men needed now. They will be needed too when the war is over. Tremendous expansion in Radio, Electronics, Frequency Modulation and Television predicted — a world of new opportunities. Get Radio Training in the Coyne Shops in Chicago now, and BE READY.

Ill Finance Your Training

If you are short of money, you can start now and pay most of your tuition after you graduate. Many earn while learning. Free Lifetime Employment Service to graduates. EXTRA training in INDUSTRIAL ELECTRONICS and Electric Refrigeration — no extra cost.

#### FREE BOOK

Whether you're 16 or up to 40, get the facts. Big illustrated book tells about your future in Radio-Electronics-Television. Mail coupon today. We also have facilities for men with physical disabilities whether due to war or other causes. Check coupon for details.

VETERANS Coyne is equipped to train those who qualify for training under the G. I. Bill of Rights. Check coupon.

M. C. LEWIS, Pres., RADIO-ELECTRONICS DIVISION  
COYNE ELECTRICAL SCHOOL  
500 S. Paulina St., Dept. 83-8M, Chicago 12, Illinois

Send me FREE BOOK on COYNE RADIO-ELECTRONICS TRAINING and details of "Pay-After-Graduation" Plan.  Send physical disability details.  Send special G. I. Bulletin.

NAME.....  
ADDRESS.....  
CITY..... STATE.....



# RADOLEK

## Radio-Electronic Service Parts

Large stocks assure the finest and most complete selections of all available items at lowest prevailing prices. Thousands of active buyers depend on us for their entire Radio repair and replacement requirements. Because we understand service problems, every order is expedited for delivery in double quick time. Everything we do is planned for convenience and satisfaction to our customers. You will find it profitable to make Radolek your buying headquarters.

### FREE BUYING GUIDES

Because of existing conditions we keep our customers right up to the minute on available merchandise by releasing supplements frequently instead of sending our regular Big Profit Guide once a year. Send the coupon now to get these Free Buying Guide Supplements as they are issued.

**FREE!**



### FAST SERVICE!

RADOLEK CO., Dept. C-108  
601 W. Randolph St., Chicago 6, Ill.

Please send FREE Buying Guide Supplements

NAME \_\_\_\_\_

ADDRESS \_\_\_\_\_

### ORDER FROM RADOLEK



**VALUABLE BOOK OF 150 ELECTRICAL & RADIO WIRING DIAGRAMS FREE!**

### YOURS FOR MERELY EXAMINING MY NEW BOOK ON ELECTRONICS

Here's an opportunity to get a valuable book of 150 Electrical and Radio Wiring Diagrams **ABSOLUTELY FREE!** It's yours for merely examining my new book **ELECTRONICS FOR ELECTRICIANS & RADIOMEN!** This **FREE** book is not just an advertising novelty—it has 150 large wiring diagrams. Yet, it's yours **FREE** if you'll agree to look over my new **Electronics** book. This new 400 page book takes all the "mystery" out of Electronics. It's practical. It covers this important subject in the language of the man "on the job." Complete amazingly easy to follow data on **INSTALLATION, TROUBLE SHOOTING and MAINTENANCE.** Endorsed and used by dozens of Electrical Unions and thousands of Electrical and Radio workers.

**SEND NO MONEY!** I'm so sure you'll like this great of 150 selected Electrical—Radio wiring diagrams **FREE** for merely letting me send you a copy of **ELECTRONICS FOR ELECTRICIANS & RADIOMEN** for 7 day **FREE** examination. **THIS OFFER IS LIMITED—Send Coupon Today!**

### FREE BOOK COUPON

H. C. LEWIS, Pres., COYNE ELECTRICAL SCHOOL, Dept. 85-T1  
500 S. PAULINA STREET, CHICAGO 12, ILLINOIS

I accept your offer. Send me **ELECTRONICS FOR ELECTRICIANS & RADIOMEN**—also the **FREE** book of 150 selected Electrical & Radio Wiring Diagrams. I'll either return the **Electronics** book in 7 days or send you \$4.95. But regardless of whether or not I keep your **Electronics** book I understand the book of 150 wiring diagrams is mine to keep as your gift.

NAME \_\_\_\_\_ Age \_\_\_\_\_

ADDRESS \_\_\_\_\_

TOWN \_\_\_\_\_ Zone \_\_\_\_\_ STATE \_\_\_\_\_

Color television, now being developed, will greatly enhance the value of the art to advertisers, says Worthington Miner, manager of television for Columbia Broadcasting System. The appeal to potential customers, especially of such items as fashions and home furnishings, is weakened by televising them in lifeless grays.

## BOAT RADIO INSTALLATIONS

(Continued from page 94)

more satisfactory arrangement is shown in Fig. 2, in which a separate set of batteries is used for the radio equipment. The radio is connected to the boat batteries only while the radio batteries are being charged. A small charger with separate batteries for the radio equipment will be a good investment.

Boats using 32- or 110-volt batteries will ordinarily have adequate facilities for charging the batteries and no other batteries or charging equipment will be required; however this should be checked and not taken for granted.

### ENGINE INSPECTION

The engine or engines should be inspected to find out what we may be up against in the way of radio noise. Are the engines shielded? If so, what is the condition of the shielding? A shielded engine may make as much noise as an unshielded one when the shielding becomes broken, corroded or oil soaked. Boats that have been put on blocks for the period of the war may have shielding that looks fine and yet sparks at every termination.

In any but a new boat time will be well spent in giving the ignition shielding a thorough cleaning. This should include complete dismantling of the ignition system, cleaning all corrosion around couplings to insure a good contact to the coupling nut all around the shielding. Any wires showing insulation deterioration from oil, cuts, or other causes should be replaced.

If the engines are equipped with auto-pulse automatic fuel pumps these should be noted as another possible source of noise. These units though generally noisy, are installed differently in different boats, so may or may not cause trouble. In some cases they operate all the time, while in other boats they may operate only until the engine starts up and the engine fuel pump supplies sufficient gasoline.

### EQUIPMENT INSPECTION

Inspection of the electrical equipment of the boat should be made to determine the condition of the wiring and to allow an estimate of the time and material necessary to correct any noise liable to be set up from this cause.

On small boats the electrical equipment may consist only of the windshield wipers and one or two blowers. On larger boats there may be a dozen or more blowers, air compressor, bilge pump, water pump, refrigerator, and any number of other things. Even though many of these are not giving trouble at present, filters should be installed on all not already so equipped. This will prevent future trouble from noise as they age and wear. Materials necessary for silencing all of this equipment should be noted.

### WIRING INSPECTION

In the wiring inspection we should note the type of wiring employed such as conduit, BX cable, lead covered cable or other. Although the wiring may be well shielded it is not always bonded together or to the ground-plate. This is particularly true with lead-covered or other

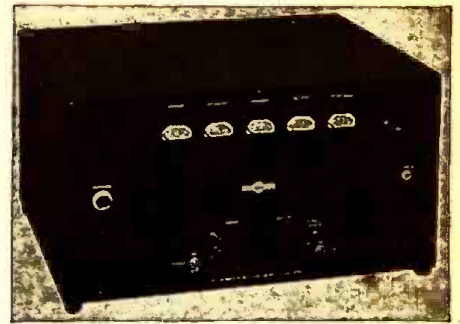

The Collins 32RA, a low-power transmitter.

cable not terminated in metal boxes. On boats having weatherproof outlets on deck for connecting navigation lights, horn, or other equipment, some of the boxes should be opened for examination. Often it will be found that the box was anything but weatherproof. Where water has gotten in some time before we may find the box completely corroded out. In some instances

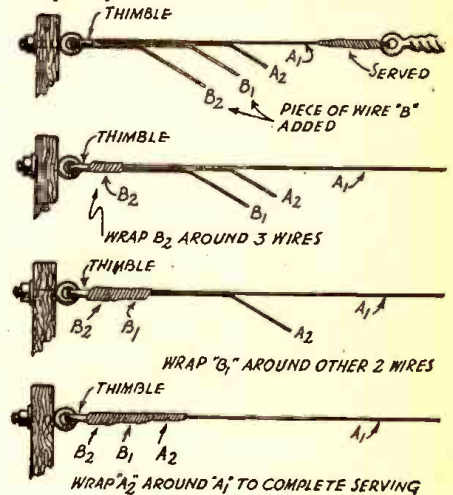

Fig. 3—Lead-ins for "T" and "inverted-L"

boxes in use seem to operate all right but fall apart as soon as they are opened for the inspection.

### GROUNDING AND BONDING

If the wiring inspection gives no sign of bonding or grounding of the controls, antenna

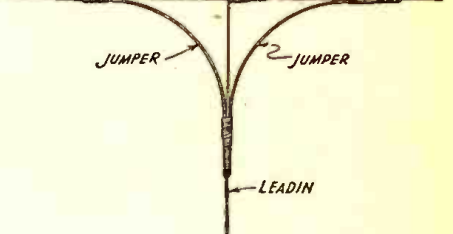

Fig. 4—Top shows how the lead-in should be connected on a "T" antenna. Bottom is the same connection on the "L" type aerial.



cable shielding, or other metal objects making intermittent contact, time and material should be figured for completely bonding the boat. This will reduce the possibility of contact noises when it is under way, and reduce conduction of noise from the engine room.

On the larger boats a ground plate may already be installed for grounding the radio and electrical equipment. If the boat is not so equipped a plate should be installed before any attempt is made to silence the equipment.

A strip of copper or copper braid laid along the keel may be used as a bus for our grounds.

### TYPES OF APPARATUS

When government surplus stock is released for market there will be a large selection of sets to choose from. The majority of the smaller boat owners will want only receiver and transmitter, some will want a radio compass. Many will want only the receiving set.

Where a receiving set only is to be installed the owner should be discouraged from using the set which "works so well" in his home. The conditions under which it will have to operate will be quite different. The average broadcast set is neither well shielded nor well built to withstand the shocks, humidity, and salt spray encountered under marine conditions. The receiver cannot be too well shielded, as good shielding is essential for quiet operation. The moisture- and fungus-proofing treatment given most army equipment will be found to greatly prolong its life. An effort should be made to obtain moisture-proofed apparatus.

The operating and standby current re-

quired by the transmitter and receiver should be considered. Much of the equipment, while excellent from an operating standpoint, requires so much stand-by and operating current that it can only be used for short periods without the batteries being charged. Transmitters are now available which are instant heating and require no standby current.

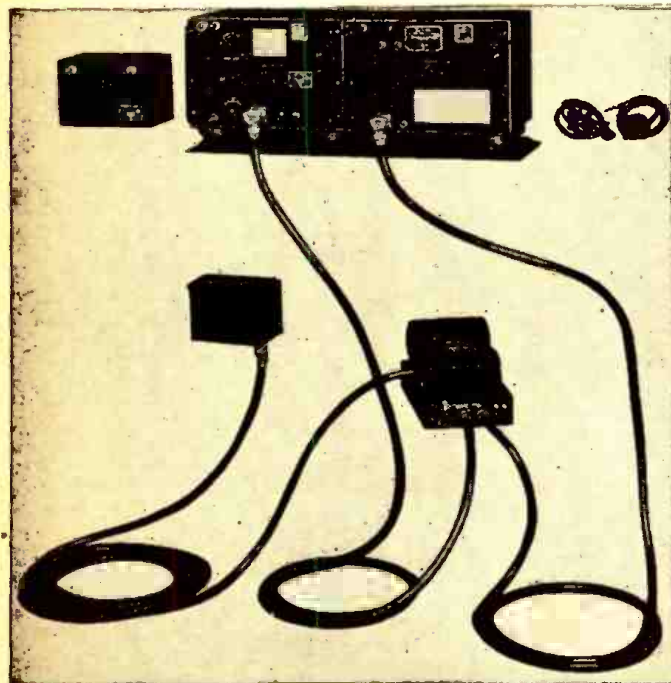

The apparatus illustrated is a Collins TCS, a marine transmitter and receiver, shown with its power supply equipment and various accessories.

when the engines are running and charging. Transmitter demands should be checked against available power before purchase. Shock mounting should be used with all equipment to reduce the mechanical vibration from the engines and to reduce the effect of the heavy wave shocks often encountered in rough water.

### INSTALLATION

One of the first things to be done is, of course, to position the equipment as desired by the owner. The antenna, ground, and power wires should be concealed where possible and run as directly to the apparatus as practicable. The antenna leads should be kept as far as possible from the electrical wiring. The ground lead should run as directly as possible to the ground plate. This was clearly demonstrated in one instance where much time was lost in attempting to remove singing in the receiver caused by the dynamotor of the transmitter power supply. After trying everything in the book to no avail the ground wire was run more directly, eliminating several bends but shortening it only a foot or two. This was all that was necessary to make the filter effective and completely remove the noise.

The rough water often encountered makes it necessary to secure the equipment to the cabinet or table upon which it is mounted. In some cases the shock mounts can be screwed directly to the cabinet or table. In other cases strips of wood may be screwed around the base of the equipment to prevent sliding. Where the apparatus is wall-mounted rubber washers should be used if shock mounts are not supplied.

The antenna should be strong enough

not to go down with the first wave that breaks over the bow. Unless hard-drawn wire is used the antenna should not be smaller than No. 10. Fig. 3 shows a strong method of securing the ends. The wire is served just as is often done by linemen when an insulator is put in a guy wire. To increase the strength at the insulator and end point another piece of the antenna wire is put beside the antenna wire. One end of the short piece is wrapped around the remaining three wires for four or five turns, the other end is then wrapped around the

(Continued on following page)

## A Better Selection from

# LAKE! RADIO cabinets & parts



Portable Phonograph case, of sturdy durable plywood, in handsome brown leatherette finish. Has blank motor board. As illustrated above, specially priced at **\$6.95**

Also blank table cabinets of walnut veneer in the following sizes, with speaker opening on left front side: (Note: 7" has center speaker grill.)

Model 1	8 1/4" L x 5 1/2" H x 4" D	\$1.95
Model 2	10 1/4" L x 6 3/4" H x 5" D	\$2.75
Model 3	13 1/2" L x 7 5/8" H x 6 1/4" D	\$3.25
Model 4	15 1/2" L x 7 7/8" H x 6 3/4" D	\$2.50
Model 5	17" L x 9" H x 8 1/4" D	\$4.50
Model 6	21" L x 9 1/4" H x 10 1/2" D	\$5.50

\*Speaker Opening in center of front side. Cabinets available in ivory color and Swedish Modern. Write for prices.

### POWER TRANSFORMERS

4, 5, or 6 Tube - 6.3v at 2 amp.	\$2.45
50 Mill Power Transformer	
7, 8, or 9 Tube - 6.3v at 3 amp.	\$2.65
70 Mill Power Transformer	

All types of radio cabinets and parts are available at Lake's lower prices. A large stock is listed in our catalog.



Write for our free new illustrated catalog.

## LAKE RADIO SALES CO.

615 W. Randolph Street, Chicago 6, Ill.

# FREE TO RADIO MEN

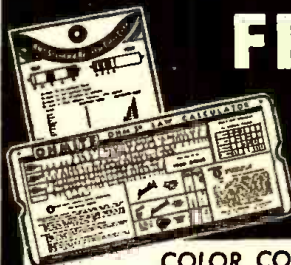

### COLOR CODE and OHMS LAW CALCULATOR

Burstein-Applebee of Kansas City offers you this great convenience FREE. Easy to work. Solves many problems in a jiffy. FREE to radio men, electronic engineers and others in the business. Attach coupon to your letterhead.

### MAIL COUPON NOW

BURSTEIN-APPLEBEE CO.  
1012 MCGEE, KANSAS CITY 6, MO.  
Send me FREE Color Code and Ohms Law Calculator along with latest catalog.

I am \_\_\_\_\_  
STATE CONNECTION IN INDUSTRY \_\_\_\_\_  
NAME \_\_\_\_\_  
ADDRESS \_\_\_\_\_  
TOWN \_\_\_\_\_ STATE \_\_\_\_\_

## GENERAL ELECTRIC TYPE 211 TUBES

Brand New  
IN ORIGINAL CARTONS  
REGULAR PRICE \$10.00  
YOUR COST.....\$3.95

ALSO ALL TYPES OF RADIO AND ELECTRONIC EQUIPMENT

McGEE RADIO & ELEC. CO.

Dept.-C 1330 Broadway  
DENVER, COLORADO



## Beautiful WALNUT CABINETS

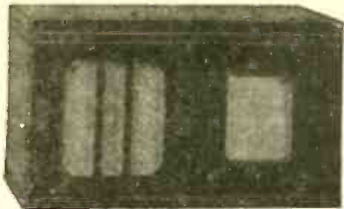

Model M-1 CUT TO FIT MEISSNER  
6 TUBE KIT 10-1199 YOUR COST \$3.95

Model C-13" L 7 1/4" H 7 1/4" D Blank.... 3.95  
Model B-12" L 7 1/2" H 6 1/4" D Blank.... 3.75  
Model A-11" L 7" H 6" D Blank.... 3.25  
Model AA 10" L 7" H 5 1/2" D Blank.... 2.95  
Model AAA 9" L 6" H 4 1/2" D Blank.... 2.45  
Model V-Phono 12x11x4" Blank.... 3.25

We can also furnish all types of Radio and electronic equipment.

MC GEE RADIO & ELECTRIC CO.  
1330 Broadway Denver, Colorado

**YOUR NEW FREE CATALOG IS READY FOR YOU!**

Radionic's Catalog No. 26 lists hard-to-get radio parts • Helps you fill your radio and electronic needs. • All parts are available for immediate shipment • All are highest quality. • All are exceptional values.

SEND TODAY FOR YOUR FREE COPY TO Dept. 11E

RADIONIC EQUIPMENT CO.,  
"CHANCELOT" PRODUCTS  
170 NASSAU STREET, NEW YORK 7, N. Y.

## Get Started in Radio



### 10 "HOW-TO-DO-IT" BOOKS

Get a solid foundation in radio by means of these 10c timely text books. Each clearly written, profusely illustrated, contains over 15,000 words. You'll be amazed at the wealth of information packed into these handy books. Excellent for reference—ideal for technical library. Your money back if not satisfied.

10c each 5 for 50c 10 for \$1.00 PREPAID  
WE CANNOT FILL ORDERS FOR LESS THAN 5 BOOKS

- |                                                                    |                                     |
|--------------------------------------------------------------------|-------------------------------------|
| No. 1—How To Make Four Doodle Short Wave Sets                      | No. 6—How To Have Fun With Radio    |
| No. 2—How To Make The Most Popular All-Wave 1 and 2 Tube Receivers | No. 7—How To Read Radio Diagrams    |
| No. 3—Alternating Current for Beginners                            | No. 8—Radio for Beginners           |
| No. 4—All About Aerials                                            | No. 9—Simple Electrical Experiments |
| No. 5—Beginners' Radio Dictionary (Leading Terms)                  | No. 10—Television                   |
- Remit by check or money order—register letter if you send cash or stamps.

RADIO PUBLICATIONS, 25C West B'way, New York (7)

## Do you need BINDING POSTS?



The XL PUSH POST with its Spring Action assures Constant Contact and Quick connection.

Manufactured in All Aluminum Type M at 12c each.

Aluminum Body, Bakelite Top Type B1 at 15c each.

Spec. CP or NP. ALL BRASS—STAINLESS STEEL SPRING & PIN. PROVEN by 240 HR. SALT SPRAY TEST as NON-CORROSIVE at 28c each.

Manufacturers and Dealers Liberal Discounts

X. L. RADIO LABORATORIES  
420 West Chicago Ave., Chicago 10, Ill.

## MAGIC & CARD TRICKS

How to Perform for Fun & Money  
Mystifying stunts made easy. Secrets of magic revealed in this new illustrated course. Teaches tricks with handkerchiefs, coins, balls, ropes, etc. Shows you how to protect yourself from card sharks... their card manipulations exposed! Get inside information on baffling stage performances. Learn how to be a magician and entertain friends. LOW PRICE! Money-back guarantee. Write today for Free details and Big Success Catalog! No obligation.  
NELSON Co., 321 S. Wabash Av., Dept. IL39, Chicago 4, Ill.

## BOAT RADIO INSTALLATIONS

(Continued from previous page)

remaining two wires, and finally the remaining end is wrapped around the antenna wire. This gives a neat, strong tie for the antenna. A good method of connecting the lead-in is shown in Fig. 4.

If the boat is not equipped with a ground plate it will be necessary to put it on the ways for this operation. This plate should consist of from 10 to 20 square feet of copper, screwed to the hull where it will be in the water at all times. Brass screws about every two inches along the edge of the plate will secure it to the hull and prevent the edge from catching on underwater obstacles. One or two brass bolts should be soldered to the plate and extended into the bilge for making connection to the plate. It is well when mounting the plate to first coat it with red or white lead on the side next to the hull. This will prevent water from seeping in between the plate and hull. Since the plate is the ground connection it should not be painted.

### CHECKING THE INSTALLATION

We now come to the most difficult part of the work. Assuming the antenna loads the transmitter satisfactorily and the receiver operates properly we may make a few contacts to satisfy ourselves that the equipment is doing all that can be expected of it with the boat at dock. The final test however, is whether satisfactory communication can be carried on while under way.

With the boat cruising at normal speed we may imagine we have undertaken an impossible task. Noise from the engines and the electrical equipment blankets all but the loudest signals. The degree to which this noise is eliminated determines which of the servicemen will continue to be called on for this type of work.

To run down the noise which will be present in almost all but the newest boats it is best to shut down everything and start up all of the noise producers one at a time, noting which cause noise and which cause none. Most of the noise, excluding the main engines, will be from blowers, windshield wipers, pump motors, fluorescent lights, and the like. The usual suppression methods should be applied to all possible noise sources. As motors and other devices collect dirt and the commutator and brushes wear, noise increases. If all these possible sources of noise are treated just as though they were bad we may save future call-backs.

On boats where the equipment is mounted close to or above the main engines the mechanical noise may be sufficient to prevent satisfactory reception. This may sometimes be greatly reduced by the application of sound-absorbing fiberboard to the walls or floor separating the engines from the radio room.

## SUPPRESSOR CIRCUIT

THE suppressor circuit shown is applied in a slightly different way than usual to a radio. It is useful in suppressing static or blasting, or can be applied to a combination radio, phonograph and recorder to prevent overmodulating the recording blank.

Some of the audio output of the set is rectified and the resulting direct current applied to the automatic volume circuit in the set as an added source of control bias.

The action may be controlled by the variable resistor connected through the 250,000-ohm resistor to the B+ supply. Rectification occurs in the diode circuit when the plate is positive with respect to the cathode. This action is not reversible within the tube ratings, as the plates are not electron-emitting surfaces. Thus if the cathodes are maintained at a positive D.C. potential above any positive value on the plates, no current will flow and no suppression is effected.

If the plates are more positive than the cathodes on voltage peaks, rectification will occur on these peaks. Current then flows through the corresponding half of the center-tapped transformer through the filter and AVC resistances and back through the tube. The resistance of the filter is low compared to most AVC resistances; thus most of the voltage developed is supplied at point X in the diagram. Since the transformer center tap is negative with respect to ground, voltage at X is negative and will decrease the gain of the tubes to which it is applied.

Usually the desired effect is to suppress static or transients, characterized by sharp wave-fronts and high instantaneous peak voltages. Sufficient bias may be maintained on the diode to prevent interference with ordinary reception.

If the suppressor is properly adjusted, the click heard in the radio accompanying electrical switching is absent. Sustained

electrical interference will greatly decrease the volume of the reception. Severe instantaneous electrical disturbances produce a short period of silence, the length of the period determined by the time constant of resistance and capacitance of the filter and AVC circuit. The expression for this is  $T = RC$ , R in megohms and C in microfarads, the time being in seconds, assuming perfect or nearly perfect condensers.

A universal push-pull output transformer is useful in adjusting the action of the suppressor. Lacking this the action may be adjusted by changing values of the 250,000-ohm resistor in series with the 250,000-ohm control to the B+, or by omitting the resistor and using a higher value of control. The values shown have been tried and proven. Suppressor action must be confined to remote cut-off tubes or serious distortion will occur.—Carl Lewis

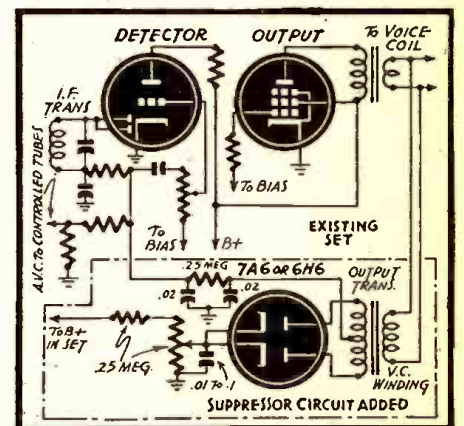

Signals from the voice coil, when they pass a critical voltage, start a current flow in the 6H6 circuit, which causes the AVC to become increasingly negative, reducing volume.



# TECHNOTES

## ... DIO-TRIODE SUBSTITUTION

I have tried using a 6SL7 in place of a 75, 85 or 6SQ7 with perfect demodulation and better AVC regulation than the original. I have also used the 12SC7 for a

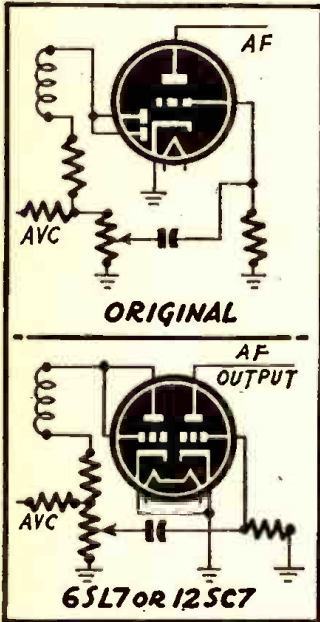

1207, 12SQ7 and 14B6 with the same results.

These changes may help someone out of a lot of trouble.

A. E. DAUBENAPECK  
Pastrop, Texas

## ... PHILCO 37-690

1500 Kc. Signal appears at 1600 Kc or higher on the dial. Trouble here is chiefly due to open condensers Nos. 40 and 41. Replace these with 250 mmfd. micas. These condensers provide the coupling to the grids of the 6N7 oscillator control tube.

WILLIAM PORTER  
Los Angeles, Calif.

## ... ECHOPHONE EC-1

The stand-by switch in this set occasionally develops a low frequency hum when thrown to the stand-by position. This is easily corrected by placing a .1 mfd. condenser from one side of the switch to ground which removed the hum completely.

ALAN JAY,  
New York City

## ... RCA VHR-207

Complaint: Low volume and severe distortion when volume control was turned up. The grid bias on the 6F6 power tubes was measured with a VTVM and found to be -100 volts instead of -23 volts. This high bias was due to a burned-out filament in the 12K7 microphone preamplifier whose tube filament operates on D.C. obtained by a parallel connection across the lower end of a section of the voltage divider in the power supply. When the tube is removed or the filament burned out high bias voltage is developed across the voltage divider.

A new tube would have fixed the set but it was not available so an 850-ohm 10-watt resistor was connected across the filament.

A good way to do this is to remove the tube base from the defective 12K7 and connect an 850 ohm resistor inside the tube base between prongs 2 and 7. This can then be plugged in and the set will function on both radio and phono. The microphone, of course, will not function without the 12K7.

When a new 12K7 is available it can be immediately plugged in by the owner on removal of the old resistor tube base and no returning of the set to the shop is necessary.

R. S. HAVENHILL,  
Monaca, Pa.

## ... CROSLEY 516

The most common complaint on this set as well as on others of the "Fiver" series is intermittent operation. If this is the complaint when brought in, check the grounded pin of the 76 tube first at the point where it is soldered to the chassis as this is one of the sore spots of these sets. The soldering connection in some cases doesn't appear to be bound firmly to the chassis, causing intermittent operation or even complete breakdown.

GORDON V. WEEKS,  
Inverness, Fla.

## ... TRUETONE D-694

When this set over-loads and the sensitivity control in the rear of the set is inoperative check the Candohm 3805 for an open circuit. This is a two-section unit of 8000 ohms 1.5 watts and a 7000-ohm 3.5-watt section. Replace open sections. This set may be found entirely inoperative. Check and replace R-33, a 20,000 ohm one-third watt resistor and C-19, a .01-400v. capacitor.

EDWARD O. LEINO,  
Minneapolis 13, Minn.

## ... ZENITH 55127

Invariably this set will be found to have a shorted by-pass condenser C-20, a 0.1 mfd, 400-volt unit, indicated by an over-heated resistor R-4, a 30-ohm, one-half-watt resistor. Replace the capacitor which is tied to the B-plus side of the I.F. transformer and to ground, also the resistor if necessary.

EDWARD O. LEINO,  
Minneapolis 13, Minn.

## ... TRUETONE D-699, D-724

When this set is noisy and inoperative, replace the one-megohm resistor in the second I.F. can.

EDWARD O. LEINO,  
Minneapolis 13, Minn.

## ... SENTINEL BATTERY SETS

Complaint, low volume. Try changing the antenna transformer even though it checks O.K. An iron-core adjustable usually is best for this work. Also try changing the electrolytic condenser even though it also checks O.K.

GORDON V. WEEKS,  
Inverness, Fla.

## ... PHILCO 70, 70A

The usual trouble in this set is that it either goes dead completely or else has very low volume. The screen by-pass condenser on the final 24A tube should be checked carefully, and replaced if there is any doubt about it.

GORDON V. WEEKS,  
Inverness, Fla.

## NOW—A REALLY HIGH-POWERED— Radio Engineering Library

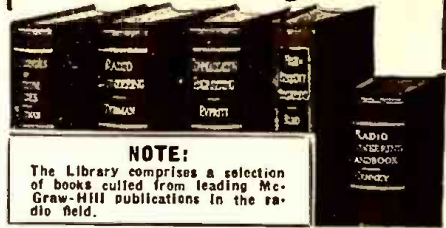

### NOTE:

The Library comprises a selection of books culled from leading McGraw-Hill publications in the radio field.

- especially selected by radio specialists of McGraw-Hill publications
- to give most complete, dependable coverage of facts needed by all whose fields are grounded on radio fundamentals
- available at a special price and terms

THESE books cover circuit phenomena, tube theory, networks, measurements, and other subjects—give specialized treatments of all fields of Practical design and application. They are books of recognized position in the literature—books you will refer to and be referred to often. If you are a practical designer, researcher or engineer in any field based on radio, you want these books for the help they give in hundreds of problems throughout the whole field of radio engineering.

5 VOLUMES, 3319 PAGES, 2289 ILLUSTRATIONS

1. Eastman's FUNDAMENTALS OF VACUUM TUBES
2. Terman's RADIO ENGINEERING
3. Everitt's COMMUNICATION ENGINEERING
4. Hund's HIGH FREQUENCY MEASUREMENTS
5. Henney's RADIO ENGINEERING HANDBOOK

10 days' examination. Easy terms. Special price under this offer less than books bought separately. Add these standard works to your library now; pay small monthly installments, while you use the books.

10 DAYS' FREE EXAMINATION—SEND COUPON

McGraw-Hill Book Co., 330 W. 42nd St. New York 18  
Send me Radio Engineering Library, 5 vols., for 10 days' examination on approval. In 10 days I will send \$3.00, plus few cents postage, and \$3.00 monthly (till \$24.00 is paid, or return books postpaid. (We pay postage on orders accompanied by remittance of first installment.)

Name .....  
Address .....  
City and State .....  
Company .....  
Position ..... RC-11-45

## MATHEMATICS FOR RADIO

Two volumes, prepared for home study. Book I (314 pp.) covers the algebra, arithmetic, and geometry; Book II (329 pp.) covers the advanced algebra, trigonometry, and complex numbers necessary to read technical books and articles on radio.

MAEDEL PUBLISHING HOUSE Room 117  
593 East 38 Street, Brooklyn, New York

Send me MATHEMATICS FOR RADIO AND COMMUNICATION as checked below. I enclose payment therefor with the understanding that I may return the book(s) within 5 days in good condition and my money will be refunded.

Name .....  
Address .....

- Book I at \$3.75 plus 6c Postage  
 Book II at \$4.00 plus 6c postage  
 Books I and II at \$7.75 postage dropaid

Foreign and Canadian prices 25c per volume higher



## SET BUILDERS SPECIALS

RADIO AND PHONO KITS

NEW ITEMS FOR THE HAM

Send for our NEW FALL CATALOG

Complete line of ALL TYPES of Radio Parts. Write today.

McGEE RADIO & ELECTRIC CO.

R-1145, 1225 McGee Street  
Kansas City, Missouri

### ATTENTION:

## RADIO MANUFACTURERS

America's finest moisture-proof tubular condensers are made by Good-All. Meet all Navy and Signal Corps specifications. Used by the millions by the Navy in the secret radar controlled shells. We are proud of our record, you'll be proud of this quality condenser in your radio. Free samples on request.

GOOD-ALL ELECTRIC MFG. CO.

Manufacturers since 1925. Oaallala, Nebraska

## THE BEST VIBRATOR

A small vibrator with a great future:  
QUIET! COMPACT! EFFICIENT!

A revolution in Postwar VIBRATOR design. Till materials are more plentiful, we will continue to rebuild old vibrators at \$1.00 each. Include return postage. Send vibrators to

BEST VIBRATOR CO.

BOX 5802-Z CLEVELAND 1, OHIO

## MANUFACTURERS!

ARE YOU INTERESTED IN INCREASING YOUR EXPORT SALES?

We are seeking additional lines for export representation either on a commission basis or can purchase for our own account paying you cash in New York funds. We handle all correspondence, paper work, details. Write Box 7

The RADELMA Company

53 Park Place New York City 7

In the Rocky Mountain Region

it's

RADIO & TELEVISION SUPPLY CO.

806 EUCLID AVE., PUEBLO, COLO.

"If we don't have it, we'll get it—  
or it can't be had! Phone 5729"



**MAGIC CUTTER**  
Cuts up to 4" hole in plastics, wood and metal. Wonder tool for amateurs and professionals, developed by famous lab for own use. Send \$1 to: Dept. C-11, ROBERTS ASSOCIATES, 510 Madison Ave., New York, 22

## BUILD YOUR OWN RADIO

It's Easy . . . We Show You How

4 tube T.R.F. Kit complete with tubes \$10.95  
6 tube Superheterodyne Kit complete with tubes \$17.95

We manufacture complete radio kits. Tubes and parts at special prices. Send for details.

RADIO KITS COMPANY

Dept. M 120 Cedar St. New York 6, N. Y.

## BUILD YOUR OWN RADIO SETS

We furnish all instructions including simple, easy-to-follow schematic diagrams. All kits complete with tubes.

4-tube T.R.F. \$10.75  
5-tube Superhet. \$17.95

Write for Circular G

NATIONAL RADIO DISTRIBUTORS

140 West 42nd Street New York 18, N. Y.

# Communications

## AN EVEN LOUDER CRYSTAL RECEIVER

Dear Editor:

In the article, Loud Crystal Radio, which was printed in the September issue, I left out one little note that is very essential. If it is convenient for you to do so, will you kindly add this information to it:

CONNECTING THE TWO STATORS TOGETHER WILL PRACTICALLY DOUBLE THE VOLUME WITHOUT THIS CONNECTION THE

VOLUME IS LOWER, BUT SELECTIVITY IS AT ITS HIGHEST. By employing alternating both methods you can have either very loud volume or the highest possible selectivity.

The set will produce twice the volume that you would normally get without the stator connections.

JOSEPH AMOROSE,  
Richmond, Va.

## COMMUNICATIONS CRYSTAL FILTERS

Dear Editor:

We, a group of radio maintenance personnel at APO 788, 57th AACSG Group, wish to express our appreciation for the manner in which your magazine presents various radio subjects.

Many a problem has been solved after reading about it in your magazine.

We wish you would publish an article

on the subject of Crystal Filters in Communication Receivers, with detailed explanations on how they work, etc., in *Radio-Craft* language!

S/SGT. M. BASSIN,  
New York, N. Y.

(We will try to supply the article.—  
Editor)

## AN IRISH AMATEUR REMEMBERS US

Dear Editor:

I have just come across a copy of your magazine, dated November, 1939, Vol. X, No. 7, in which you have a picture of my Amateur Radio card E7L on page 413 . . . Thanks a lot, it does feel good that someone thinks it is O.K. . . . Your paper is really very interesting and I would like to get it regular after things have settled down, if it is not out of circulation as the result of the war. . . . Please tell all the Hams (through your paper) that I am still here and anxious to get back on the air

again, when we get our gear back from the authorities. Please tell them that I have changed my address from 137 to 90 North Circular Road . . . ask them to write to me NOW and ANYTIME and give them all my Vy 73s. Hi!

Let me have the name of the best USA transmitters and high class receivers; I hope to get new gear after a very short while, and then I want to get the very best. Sincere good wishes and good luck.

ANDREW J. KETTLE,  
Dublin, Ireland

## SUGGESTION FOR ALARM CIRCUITS

Dear Mr. Gernsback:

Your editorial in the current issue of *Radio-Craft* emphasizes a need that will become more explicit as the special applications of radio, such as facsimile and civilian radio, come into popular use. Undoubtedly you recollect the automatic SOS receiver developed by RCA some years ago. As you pointed out, such devices have required considerable current outlay because of the necessity of keeping the pilot tube lighted constantly.

If your suggestion of a vacuum coherer is found to be impracticable undoubtedly some tube designer will come up with a cold cathode job that will do the trick with an extremely low current demand.

I think editorials such as the one I refer to have a real value in emphasizing future needs of the industry.

Yours very truly,  
E. L. BRAGDON,  
Department of Information,  
Radio Corporation of America.

## DOESN'T LIKE SERVICEMEN'S LICENSES

Dear Editor:

The plan to license radio service men is an invitation to start another racket for big monopoly. These men would have us take out a license that would involve more than just the ten dollar a year fee to do business. It would mean that some one or several men with the connections could make the license requirements so stiff that they could push out the average small one-man business. It could be done like the garage business in our state, for instance. Certain men are trying to push through a law that will kick out of business anyone unless their place contains a certain specified sq. feet of floor space, which could eliminate the one man shop. Is this Americanism?

Taking out a license will not improve the service work. Let the screw driver beginner have his fling; so much more work for us. I have repaired radios for 15 years; my own business for past 9 years, and found that in about 98 per cent of the cases where

wrong work had been done it was either the owner of the set that told me he had done such, or, in most cases, some "well-known" establishment that hired cheap help and fast workers.

Most of the men working to have the license law passed will wake up and realize later that they were digging a hole to get stuck in. Taking out a license is no guarantee that there will be a living wage in our work after the war; that will be up to us. If we will do good work and make our prices so our profit will be fair and NOT try to chisel the other fellow; none of that misleading advertising of one dollar plus parts bunk; no free service work claims—if we avoid these practices I believe we will come out OK.

There have been no large business interests trying to take our work away from us thus far; let's keep it that way.

JOHN FRAANJE,  
Grand Rapids, Mich.



## RADAR—WEAPON FOR PEACE

(Continued from page 92)

Of related importance in landing aircraft in fog or overcast and averting collision between two planes is the practical application of radar in "seeing" a mountain or other natural obstruction (such as the Empire State Building). Being forewarned the pilot is forearmed. Already, a radar altimeter has been developed, which determines the actual height of a plane from the ground rather than defining altitude in terms of sea level. It is so sensitive that it registers the height of railway rails or fences as a plane flies overhead.

Of equal importance to anti-collision radar devices for aircraft and as a "homing pigeon" for guiding planes to their home bases, is the use of this "seeing eye" on ships so that their captains may dodge icebergs and avoid colliding with other ships in obscure weather at sea. Recently, the General Electric Company demonstrated the practical application of the "electronic navigator" which with its radar can visualize through the blackness of night, fog and storm the positions of any obstructing obstacles above water, such as lighthouses, buoys, icebergs, other ships and land, at distances up to 30 miles, depending upon the size and shape of the object. Functioning in accordance with the principles of radar, in that "pulses" of radio waves being spurted out are reflected from the object, and are measured to afford true bearing and distance of the object from the sending point, the electronic navigator consists of: a rotating antenna, situated on the top deck of a ship and comparable in action to a searchlight, in that it "flashes" concentrated radio beams to detect obstructions in the path of the ship. There is this notable difference: the beams from the radar antenna (actually powerful radio micro-waves),

going in different directions. Some of these echoes or broken-up waves return to the rotating antenna. This aerial, which a split-second before was a transmitting antenna, acts as a receiving interceptor during the time intervals between the outgoing surges of waves. Upon being amplified, the returning echoes assume the appearance of bright spots on the face of a cathode-ray tube. The latter is similar to a television screen tube. The image formed on the radar screen gives the operator or ship's captain a "radar picture" of the obstacle ahead. Marker rings indicate how far away the obstruction is located.

### RADAR AS SURVEYOR

Since George Washington employed a tedious and time-consuming surveyor's instrument, the problem of surveying and mapping America's vast reaches of land and water has plagued our map-makers. The airplane, in recent years, has speeded up the job, but days must be clear if the conventional methods of air mapping are to succeed. Radar may offer the solution, since the Navy Department has said, so dramatically, "The ship has been discovered, identified, tracked, fired upon, and sunk without a man seeing it visually." Similarly, uncharted areas of land and water (although radar cannot see under water) may be mapped by radar or electronic techniques. As a guiding precedent, a map of Germany was taken during the war, and the country's entire terrain, as seen through the "eyes" of radar, was rendered available for the study of military leaders in the strategic planning of the progress of the world conflict. Bombardiers also used these radar maps by comparison with the "pictures" on their radar screens in guiding their bombers unerringly to strategic targets. The layout of valleys, hills, lakes, towns, and cities, in true relation to each other, showed up on the radar map with unmistakable accuracy. Like a radiologist skilled in the study of X-ray pictures, experts in radar could distinguish forests from towns and cities. Even more remarkable, a radar photograph of New York City shows the docks on North River.

The Forest Service of the U.S. Department of Agriculture may adopt radar and electronics in the administration of nearly 200,000,000 acres of Federal domain. A revised or modified version of "Mickey," the radar device on bombers, might conceivably be a valuable ally of forest supervisors and rangers in surveying certain wooded areas, estimating big game animals and tracking down incipient forest fires. All these possible and indirect uses of radar presume the use of airplanes and modified installations of radar systems on these planes.

### ALSO FOR BIRDS AND INSECTS

An educator, Professor Maurice Brooks, of West Virginia University, has suggested the miracle-working radar as a means of following the flights of migratory birds. When a naval officer, on a ship in the Pacific theater of operations, he noted that radar frequently detected the presence of large birds 5,000 feet distant, when the creatures were invisible to the human eye. It occurred to Professor Brooks that their usual migration flights could be thus traced. The Bureau of Biological Survey of the U.S. Department of Agriculture might well adopt this novel means of studying birds

(Continued on following page)



Plan Position Indicator with mock bombsight.

penetrate fog or other thick atmospheric conditions with the facility of a sharp knife slicing through a chunk of cheese. The "pulses" or surges of micro-waves are of extremely limited duration and they pulsate at an extremely rapid rate.

When these very-high-frequency radar waves "strike" an obstacle in surrounding waters the micro-waves bounce off the obstruction and scatter, somewhat in the manner and rapidity of a flushed covey of quail

# RADIOMEN'S HEADQUARTERS BUFFALO RADIO SUPPLY

219-221 Genesee St., Dept. N  
Buffalo 3, N. Y.

ALL KINDS OF RADIO TUBES IN  
STOCK AT BEST WHOLESALE  
PRICES

Mail in your orders for all types needed,  
not just the critical numbers, and we'll  
try to fill them completely!!!!

Bargains in Wire: No. 18 POSI, 2 conductor parallel rubber Zipcord, black or brown, 250' spool—\$4.25; No. 18 FF (fixture wire), 1000' or 2000' spools \$6.95 per M; No. 18 SV, round rubber covered double wire for electric drills, wash machines, etc., 250' for \$5.95; No. 16 single conductor stranded with spun glass 5000V, insulation, per foot—.02; No. 18 PO brown rayon covered parallel lampcord, 250' spool—\$4.50. All kinds of hook-up wire in stock. Replace broken radio plugs with new bakelite plugs or caps, 100 for \$2.00.

27 most popular asst. radio dial belts in metal cabinet with belt hook—\$3.75.

Universal Microphono Co. high grade Model W sensitive single button Carbon microphone with diagrams for use included, only \$2.35; 3 pole double throw slide switches—\$.15; Highest quality Stromberg Carlson input and output Push-Pulls in single brown crackle case (for 6F6, 6V6, etc.)—\$1.20.

SPEAKER SPECIALS—P Magnet Dynamics—2 1/2"—\$1.45; 4"—\$1.45; 5"—\$1.25; 6"—\$1.75; 8"—\$3.95; 10"—\$5.95; 12" (21 oz. magnet)—\$7.95. ElectroDynamics—4", 6", or 8"—\$1.50.

68" highest grade standard type 3 section car aerials—\$1.10, with lead \$1.50.

115 V., 60 cycle, Half Shell Power Transformers at prices you can't beat. 4 or 5 Tube sets, 650V, 40MA, HT. 5 V Fil. and either 6.3 or 2.5 Fil—\$1.40. 5 or 6 Tube Sets, 650V, 45 MA, HT. 5 V Fil. and either 6.3 or 2.5 Fil—\$1.55. 6 or 7 Tube Sets, 675V, 50 MA, HT. 5 V Fil. and either 6.3 or 2.5 Fil—\$1.70. 7 or 8 Tube Sets, 700V, 70MA HT. 5 V Fil. and either 6.3 or two 2.5 Fil—\$2.05. 9 to 11 Tube Sets, 700V, 100MA, HT. 5 V Fil. and either 6.3 or two 2.5 Fil—\$2.75. Filter Chokes. Cadmium Plated Straps, 2" Mounting, 200, 300, 400 or 500 ohms. AUDIO TRANSFORMERS: 1 Plate to Single Grid, 3:1, \$3.69; 1 Plate to Push-Pull Grids, 3:1, \$3.69; Universal Output Tapped for Various Impedances—\$3.79; Single or Double Button Mike Transformers—\$3.69.

High Grade Wobster Crystal Pickups—\$3.75.

Condensators Guaranteed 1 year. Prices in lots of 10, either 1 type or asst. 100 Mfd, 25V—35; 50 Mfd, 150V—45; 20-30 Mfd, 150V—40; 20-20 Mfd, 150V—30; 25 Mfd, 25V—20; 10-10 Mfd, 450V—45; 20 Mfd, 150V—20; 16 Mfd, 450V—40; 12 Mfd, 150V—15; 10 Mfd, 450V—27; 10 Mfd, 50V—15; 8 Mfd, 450V—23; .25 Mfd, 600V—18; 1 Mfd, 600V—10; .05 Mfd, 600V—09; .02 Mfd, 600V—06; .01 Mfd, 600V—08; .005 Mfd, 600V—05; .005 and all smaller capacities in 600V ratings—.07 each, 100 asst. new but outdated condensators. No guarantee, average 3 pounds—.90.

Bullet Crystal Mikes—\$5.45; Bullet Dynamic Mikes—\$7.45. Free Stroboscope with each order while supply lasts. Send for our test equipment catalog.

**LOWEST PRICES! COMPLETE STOCKS! FAST SERVICE! STANDARD MERCHANDISE!**

• Ted McElroy

World's Largest Manufacturer of  
Wireless Telegraphic Apparatus  
COMPLETE CENTRAL OFFICE EQUIPMENT

McElroy Manufacturing Corp.

82 Brookline Avenue • Boston, Massachusetts

HAZELTON INSTRUMENT CO.

Electric Meter Laboratory

Electrical instruments, Tube Checkers,  
and Analyzers repaired.

140 Liberty St., New York, N.Y.

Tel. BArcley 7-4239

★ BUY A VICTORY BOND ★



## MINIATURE TUBULAR CONDENSERS

Specialists in the manufacture of tiny, paper, tubular, condensers for hearing aids, portable radios, etc. Moistureproof, High I.R., accurate capacity, and very small physical dimension. We make them by the millions for the armed forces. Tell us your needs.

**GOOD-ALL ELECTRIC MFG. CO.**  
Manufacturers since 1925.      Ogallala, Nebraska

## PATENTS—TRADE MARKS

Booklet concerning Inventions & Patents Form "Evidence of Conception" with instructions for use and "Schedule of Government and Attorneys Fees"—Free.

**LANCASTER, ALLWINE & ROMMEL**  
Registered Patent Attorneys  
436 Bowen Bldg.      Washington 5, D. C.

## If It's a CANNON-BALL



### It is a GOOD HEADSET

For clarity of tone use Cannon-Ball sensitive phones. Assure dependable performance. Guaranteed to give absolute satisfaction. Write Headset Headquarters for folder R-11 illustrating complete line.

Scientifically built Heavy bar magnets greatly increase their efficiency.

**C. F. CANNON COMPANY**  
SPRINGWATER, N. Y.

## THE OHMITE HANDY

### OHMS LAW CALCULATOR

The answer to any Ohms Law problem, instantly, with just one setting of the rule, is yours absolutely free for the asking. Write us on your letterhead. We will also enclose our latest flyer which is crammed full of those hard-to-get parts.

National Radio Parts lead the field.  
**NATIONAL RADIO DISTRIBUTORS**  
140G West 42nd Street      New York 18, N. Y.

## Be Your Own Boss!



### START A GOOD-PAYING BUSINESS!

Stop worrying about a post-war job. Why let yourself be pushed around by economic conditions, as business slows down—when you can run your own so easily? We will show you how!

Get started at once with the aid of "CASH IN," the amazing short-cut guide to success. It contains

### 300 WAYS TO MAKE MONEY

It shows you how to begin—either in a small way in your own home and branch out big—or how to open a shop at once with profits rolling in immediately. It's chock full, from cover to cover, with tested money-making plans, formulas, business secrets, and sure-fire success schemes.

You can start with as little as a few dollars' capital. All you need to do is pick out the one business that appeals to you most—follow the simple directions—and then go to it!

66 PAGES —

40,000 WORDS IN TEXT

Send for "CASH IN" today. Enclose 25c, that's all—you won't be asked for another cent—now or later. Sold on a money-back guarantee. **25c**

**NATIONAL PLANS INSTITUTE**

P. O. Box 26R, Station N, New York 23, N. Y.

## RADAR—WEAPON FOR PEACE

(Continued from previous page)

as they fly from one section of the country to another, with the caprices of weather. Also, this suggestion carries a veiled hint that Uncle Sam could trace and study his banded birds by some modified form of radar. Mistaken as "enemy targets," a flock of pelicans was picked up by radar in San Francisco in 1943, causing an hour air-raid alert.

Crop surveys and insect-dusting operations, more and more being done from the air rather than by time-consuming ground travel, may invite some form of "magic eye" in the performance of these agricultural chores. Thousands of voluntary crop reporters could be dispensed with, if the airplane and the science of electronics could devise some effective unison whereby the vast acres of growing crops can be seen, surveyed, and studied from the air. When America is literally the world's bread basket it becomes of increasing importance that the Government have a foreknowledge of growing conditions, and an estimate of the extent of the harvest.

## MOBILE APPLICATIONS

While the Joint Board of Scientific Information Policy for the Federal Government cautions, "In the forms in which it exists now, radar is not a very useful attachment to an automobile or a railroad locomotive," it is to be assumed that these same scientists would not put chains on progress by circumscribing the efforts of less-cautious radio engineers who might attempt to modify and adopt radio to the peacetime uses of these same railway trains and automobiles. Conceivably, it is not beyond the realm of possibility, that a refined radar seeing instrument may be installed on front and rear ends of railway trains for the purpose of averting collisions,

(Continued on following page)

## RADIO TERM ILLUSTRATED



Suggested by:  
Edward J. Reid, Seattle 5, Mich.

High Voltage Receiver.

## Index to advertisers

Aerovox Corp.	126
Alexander Hamilton Institute	124
Allen Manufacturing Co.	120
Allied Radio Corp.	122
Amperite Co.	115
Amplifier Co. of America	135
Audel & Co., Theo.	112
Best Vibrator Co.	140
Buck Manufacturing Co.	123
Buffalo Radio Supply	141
Burgess Battery Co.	121
Burstein-Applebee Co.	137
Cannon Co., C.F.	142
Capitol Radio Eng. Institute	113
Concord Radio Corporation	117
Coyne Electrical School	135, 136
Creative Research Co.	143
DeForest's Training, Ina.	81
Electronic Service and Supply Co.	134
Galvin Mfg. Co.	Back Cover
General Cement Mfg. Co.	129
General Electric Co.	125
Good-All Elec. Mfg. Co.	140, 142
Hallcrafters Co., Inc.	79
Hazelton Instrument Co.	141
Henry Radio Shops	127
International Detrola Corp.	75
Kelnor Mfg. Co.	134
Lake Radio Sales Co.	137
Lancaster Allwine & Rommel	142
MacMillan Book Co.	116
McElroy, T. R.	141
McGee Radio & Electric Co. (Kansas City)	140
McGee Radio Co. (Denver)	137, 138
McGraw-Hill Book Co.	139
McMurdo Silver Corp.	123
Maedel Publishing House	139
Mallory & Co., Inc. P.R.	76
Meissner	Inside Front Cover
Murray-Hill Books	106, 107
National Radio Distributors	140, 142
National Radio Institute	73
National Schools	83
National Union Radio Corp.	74
Nelson Co.	138
Onan & Sons, D. W.	129
Opportunity Adlets	143

## RADIO SCHOOL DIRECTORY

Page 144

American Radio Institute
Candler System
Capitol Radio Engineering Institute
Commercial Radio Institute
Delehanty Institute
Melville Radio School
RCA Institutes
Tri-State
Western Radio Institute
YMCA

Radio Kits Co.	140
Radio & Television Supply Co.	140
Radio Electric Service	127
Radio Wire Television, Inc.	133
Radionic Equipment Co.	138
Radolek Company	136
Raytheon Mfg. Co.	110
Rider, John F.	119
Roberts Associates	140
Sprague Products Co.	80, Inside Back Cover
Sprayberry Academy of Radio	77
Superior Instruments Co.	111
Supreme Instruments Corp.	130
Supreme Publications	109
Sylvania Electric Co.	84
Thordarson Electric Mfg. Division	115
Triplett Elec. Instrument Co.	82
Ungar Electric Tools, Inc.	132
Van Nostrand	131
Wholesale Radio Laboratories	128
X.L. Radio Labs.	138



or for detecting such collision-causing obstructions as a washed-out bridge, a cow, or a landslide. Radio is already being used by railroads for signaling and in attempts at avoiding accidents.

More problematical, however, is the adaptation of radar to the flexible uses of 30,000,000 automobiles and trucks, though an unbridled imagination could visualize a miniature radar screen on the dashboard of a passenger car. In a cross-country tour from New York City to California, the motorist would actually be guided by a beam of light on the dashboard, thus avoiding an oncoming automobile at night, averting an accident at a railway crossing and steering clear of a poorly lighted parked truck alongside the highway. An electronic indicator would visually or audibly warn of approaching dangers that might lurk in fog or other obscure weather conditions.

Like an amethyst set amidst pearls, radar is a potential nugget of great wealth as the heart of the electronic industry—a billion dollar enterprise. The Army and Navy spent \$2,700,000,000 for radar equipment during the war. Expenditures of the Army and Navy for radar equipment were: \$1,000,000,000 worth of airborne equipment, \$500,000,000 worth of shipborne equipment, \$800,000,000 worth of ground radar devices, and \$400,000,000 worth of miscellaneous radar.

It will require an army of more than a million men to make the parts, modify them to peacetime services, and keep radar parts repaired. As a nucleus for these trained radar operators and repairmen, more than 125,000 officers and men of the Navy have graduated into advanced radar training at Navy schools; the American Air Forces turned out 23,175 radar graduates during the first six months of this year; and at the termination of the overseas electronics training program 907 Signal Corps officers had completed their technical education—457 British Army radar, and 450 in Royal Air Force equipment.

The Office of Scientific Research and Development, the War Department, and the

Navy Department, in a unified statement, appraise the peacetime potentials of radar in language couched in conservatism, as to explicit details, but glowing in general terms of optimism, as follows:

"The biggest influence radar will have is indirect. The thousands of man-years which have gone into the improvement of the detailed components which make up a radar set—many of these components being identical with those of a radio or television set, or hearing aid, or other electronic device—have made obsolete many of our pre-war ideas about what could and could not be done in electronics.

"Furthermore, radar has made the electronic industry one of America's major ones, now comparable in size to the prewar automobile industry. This new industry, through its enormous laboratories, can be expected to find innumerable applications in a wide variety of fields.

"If television is still around the corner, nothing but economic factors, not technical ones, will have kept it there. Communication, especially radio communication, will have a tremendous flowering based largely on the opening up of the microwave field.

"Individual radio communication is even beginning to appear a practical matter, subject to certain limitations.

"The number of men who have been trained in the techniques of radar operation and maintenance by the Army and the Navy is colossal; we can expect these men, in large part, to make feasible the greatly expanded use of electronic equipment of all kinds, because of their preparation to enter the industry or to set up in the parts and repair business.

"Altogether, it is fair to say that radar, as radar, will have a mild immediate beneficial effect on all our lives, by making it safer to travel by sea or by air. But the impact on electronics generally of techniques developed during the war because of radar will have profound and far-reaching effects on the shape of our daily life."

## PHONO NEEDLE TESTS

(Continued from page 99)

needle will play without causing excessive wear, depends largely on the weight of pressure of the pickup arm on the needle. These tests were made with six identical automatic record-changers having two-ounce arms. With a heavier arm you would get fewer plays and with a lighter arm, more plays per needle. Thus far the tests have shown that the following needles have widely varying characteristics: The Fidelitone and the Fidelitone De Luxe are among the least likely to damage records and are satisfactory with respect to tone reproduction and durability. The Recoton Sapphire which sells for \$5.00 a needle—ten times the price of the lowest-priced needle, the Fidelitone—did more damage to the records than any other of the needles tested so far, and the Walco Genuine Sapphire was nearly as bad as the Recoton. Harder on record surfaces but not nearly so bad as either the Walco or Recoton, was the Pfanstiehl. The Concertone 2500 needle was as easy on the records as the Fidelitones, but its useful life, despite the promise of 2500 plays, was too short to put it in the same class with other permanent needles.

The needle which gave the widest tone range was the Recoton, but it was so damaging to the records as to be wholly unacceptable for regular use. Poorest reproduction of high frequencies was shown

by the Fidelitone Master. Even after 2000 plays, the Fidelitone needles caused less wear than the new, unused Recoton or Walco needles, and only slightly more wear than the Pfanstiehl.

These tests were conducted over a period of several months, after a full year's study of various test methods. The tests have not yet shown how resistant the needles are to accidental damage, as when the pickup arm is dropped, or the needle is accidentally pushed across the grooves. This is a consideration especially important to those who have a manual rather than an automatic record player.

*Consumer Reports* states that there are still forty-odd brands to be tested, and that each test must, of necessity, take a full week. From this we surmise that a needle might yet be found that would combine both the low record wear of the Fidelitone with the excellent tonal range of the Recoton, though this might be like the proverbial search for the needle in a haystack.

Television on a one-man scale was seen as the answer to small-town television station operation by Philip Merryman, director of facilities and research development of NBC. A station could start with

## LOOK FOR . . .

Our Special Announcement

in the next issue of

### RADIO-CRAFT

ON

## THE NEW FLUORESCENT LAMP TESTER & STARTER

PRICED ABOUT — \$6<sup>00</sup>

Write for Our Advance Circular

Covering All Details

### CREATIVE RESEARCH COMPANY

6805 20th Ave.

Brooklyn, N. Y.

## OPPORTUNITY AD-LETS

Advertisements in this section cost 20 cents a word for each insertion. Name, address and initials must be included at the above rate. Cash should accompany all classified advertisements unless placed by an accredited advertising agency. No advertisement for less than ten words accepted. Ten percent discount six issues, twenty percent for twelve issues. (Ineligible or unsuitable advertisements not accepted. Advertisements for December, 1945, issue must reach us not later than October 26, 1945. Radio-Craft • 25 W. 87th • New York 7, N. Y.

**FAST FREEZER: BUILD YOUR OWN. WITH OUR** detailed plans. Conserve perishables. Plans easy to follow; saves up to 75%. Use new or old parts; operates on 32-110 volts. \$1.00 brings complete plans for 8 to 40 cu. ft. sizes and catalog. Loday Mfg., 956 Loday Bldg., Minneapolis, Minn.

**HARDWARE AND RADIO KIT—CONTAINS 1000** items for repairing and experimenting—bolts, screws, nuts, washers, rivets, spacers, springs, studs, eyelets, cotter pins, lugs, brackets, angles, etc. Pieces bakelite, fiber, formica, mica, mycalex, rubber, bimetals. Also coils, sockets, condensers, resistors, rheostats, etc. \$2.00 per kit. Sent C.O.D. **RADIOCO**, 1116 R Marshall Bldg., Cleveland, O.

**RADIO HAMS—EXPERIMENTERS—QUARTZ CRYSTAL** kit now available containing all necessary material to finish your Xials at home, complete with plug-in holders. Processed quartz blanks, and instructions. Experimental kit \$5.00. Professional kit \$10.00. (When ordering professional kit state fundamental frequency desired.) **SELETRONICS, INC.**, P.O. Box 200, Carlisle, Penna.

**WANTED: A COMPETENT SERVICEMAN TO REPAIR** radios. We have 3 cars and service 5 rural counties. Must be experienced and of good habits. Write fully. **JOLLY RADIO SERVICE**, Gulrock, N. C.

**CORRESPONDENCE COURSES AND SELF-INSTRUCTION** books, slightly used. Sold, Rented, Exchanged. All subjects. Satisfaction guaranteed. Cash paid for used courses. Complete information and 92-page illustrated bargain catalog free. Write—**NELSON COMPANY**, Dept. 2-39, Chicago 4.

**MULTITESTER FOR SALE. BRAND NEW \$18.75.** Order Today. Omaha Radio Products Co., 300 Brandeis Theatre Bldg., Omaha, Nebr.

**MAGAZINES (BACK DATED)—FOREIGN, DOMESTIC,** art, books, booklets, subscriptions, pin-ups, etc. Catalog 10¢ (unfunded). Ciccone's, 803 First Ave., New York 17, N. Y.

**UNIVERSAL RADIO TOOLS—DANDY 16 PIECE SET:** Midset Pillars, Diagonal Cutters, Four Midset End Wrenches, Needlenose Pliers, Screw Holder, Six Punches and Chisel, Round File, Midset Crescent Wrench, \$14.85. Remit with order. Immediate Shipment Overnight by Air to Anywhere, U.S.A. **Universal Tool Company**, 1527 Grand St., Kansas City, Mo.

**EMBOSSED AND PLAIN BUSINESS CARDS. SPADA,** 10 Lexington, Wethersfield 9, Conn.

**AMATEUR RADIO LICENSES. COMPLETE CODE** and theory preparation for passing amateur radio examinations. Home study and resident courses. American Radio Institute, 101 West 63rd Street, New York City. See our ad page 144.

**AVAILABLE AT ONCE—RECEIVERS, TRANSMIT-** ters. Test Equipment of all types. U.S. Government surplus at Bargain Prices. Write for full details. **Radio Kits**, 120 Cedar St., N. Y. C.

**BUILD RADIO COMPLETE, WITH TUBES \$10.95,** details. Radio, 9418b Avenue "A", Brooklyn, N. Y.

simple productions, requiring only one control operator and an announcer. Camera and lights would be in fixed positions, and performers would use specific portions of the stage.



# RADIO SCHOOL DIRECTORY

PREPARE NOW FOR POST-WAR RADIO AND ELECTRONICS

MAKE a place for yourself in a new world of radio and electronics—a world in which revolutionary electronic developments will require highly specialized technical knowledge. Take a good course now to fit yourself for a good paying job. The training you need can be supplied by one of the schools advertised in this publication.

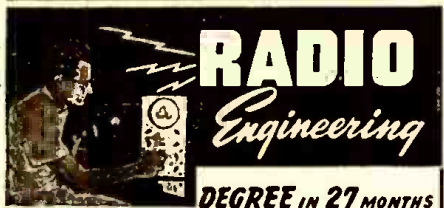

## RADIO Engineering

**DEGREE IN 27 MONTHS**

Complete Radio Engineering Course in 27 months. Bachelor of Science Degree. Radio (television, talking pictures and the vast electronic field) offers unusual opportunities. Men and women. **VETERANS** under the G. I. Bill or Public Law 16 can complete work here in shortest possible time. Special Prep. Dept. Also Refresher Courses. Courses also in Civil, Electrical, Mechanical, Chemical, Aeronautical Engineering; Business Administration, Accounting, Secretarial Science, Tuition, living costs low. Enter January, March, June, September. 62nd year. Write for Catalog  
24115 College Ave. Angola, Ind.

**TRI-STATE COLLEGE**

## RADIO

RADIO Technician and Radio Communications courses. Register now for new classes starting first MONDAY of each month. Day and Evening Classes.

**AMERICAN RADIO INSTITUTE**  
101 West 63rd St., New York 23, N. Y.  
APPROVED UNDER GI BILL OF RIGHTS.



Be a "key" man. Learn how to send and receive messages in code by telegraph and radio. Commerce needs thousands of men for jobs. Good pay, adventure, interesting work. Learn at home quickly through famous Candler System. Write for FREE BOOK.

**CANDLER SYSTEM CO.**  
Dept. 3-M, Box 928, Denver 2, Colo., U. S. A.

### RADIO COURSES

- RADIO OPERATING
- RADIO SERVICING — ELECTRONICS
- REFRIGERATION SERVICING
- CODE

Personal Counselling Services for Veterans Write for Latest Trade & Technical Catalog

**Y.M.C.A. TRADE & TECHNICAL SCHOOLS**  
4 W. 64th Street New York City

### LEARN RADIO IN DENVER

LOWER LIVING COSTS  
Straight technical course with 3 months training plus 3 months actual radio servicing experience at pay. Day and evening classes.

**WESTERN RADIO INSTITUTE**  
1457 Glenarm. Dept. RC, Denver 2, Colo.

### COMMERCIAL RADIO INSTITUTE

A radio training center for twenty-four years.

**RESIDENT COURSES ONLY**

Broadcast, Service, Aeronautical, Television and Marine telegraphy classes now forming. Literature upon request. Veteran training. Classes now forming for mid-year term February 1st.  
Dept. C, 38 West Biddle St., Baltimore 1, Md.

Electron microscopy may solve the mysteries of plant growth, according to Dr. Francis O. Schmitt, Professor of Biology at the Massachusetts Institute of Technology.

## LEARN RADIO IT HOLDS A FUTURE FOR YOU!

### PRACTICAL SHOP COURSES IN SERVICE & REPAIR F-M & TELEVISION

Theory and Practical Work interestingly combined and taught by expert instructors. Fully equipped shops and laboratories.

**DAY & EVE. CLASSES**

MODERATE RATES INSTALLMENTS!

Approved by both N. Y. State Dept. of Education and Veterans' Administration.

Qualified Veterans may obtain this training under Government auspices.

Visit, write or phone for Free Details.

## DELEHANTY Institute

School of Radio, Electronics and Television  
105 East 13th St., New York ST. N.Y. 9-690



## RADIO

Train with professionals. Complete, intensified courses: Repair & Maintenance, Communications, High-speed telegraphy, Slip transcription, FCC exams, etc.

High School Students accepted for training as Merchant Marine Radio Officers. Gov't sponsorship available to veterans.

"A Radio School managed by radio men."  
45 W. 45th St., Dept. RC, New York 19, N.Y.

**MELVILLE RADIO INSTITUTE**

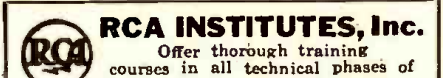

### RCA INSTITUTES, Inc.

Offer thorough training courses in all technical phases of Radio and Television

DAYS-EVENINGS WEEKLY RATES

**VETERANS:** RCA Institutes is approved under G. I. Bill of Rights

For Free Catalog Write Dept. RC-45

**RCA INSTITUTES, Inc.**  
A Radio Corporation of America Service  
75 VARICK STREET NEW YORK 13, N. Y.

### RADIO-TELEVISION

ENGINEERING & SERVICING

Now Training Veterans Under "G.I." Bill Prepare now for profitable career! ENTER AT ANY TIME. Residence school classes in Radio-Electronics Engineering, Broadcast & Television Engineering and Servicing. Write for FREE Booklet

Capitol Radio Engineering Institute  
Dept. RC-11, 2224 16th Street, N. W., Washington 10, D. C.

See Big Ad. Page 113

Twenty-eight percent of radios in use should be replaced immediately, according to a recent survey. Figures were based on ages of radios now in use as compared to the average prewar replacement age. Despite their age, practically all these radios are giving good service.

"It is an extremely powerful tool," he explained, "for the investigation of cellular structure but requires a great deal of development before it can be most fruitfully applied in biology and medicine."

## LICENSING PROBLEMS

(Continued from page 120)

the City of Madison shall be ex officio the sixth member of said board. Of the four appointed members two shall be licensed radio servicemen who are employers and two shall be licensed radio servicemen who are employees. . . .

(3) Licenses. How obtained. Any person desiring a license as a radio serviceman shall make application therefor to the Board of Examiners of Radio Servicemen who shall then examine each applicant, at such place as it shall designate, as to his qualifications and competency to work at the profession of radio and electronic serviceman. The examination shall be both theoretical and practical in character and shall embrace both oral and written questions sufficiently strict to test the qualifications of the applicant. The examination shall also require a demonstration of skill through the actual repairing of electronic equipment. The said board shall, upon being satisfied as to the competency and good moral character of the applicant and upon payment by the applicant of the license fee as herein provided, issue to such applicant a license authorizing him to engage in radio and electronic servicing and installation. If the applicant fails in his examination the application fee will not be refunded but he will be permitted to take another examination at the next stated examination period.

(4) License Fee. The fee for a new applicant for a radio serviceman's license shall be the examination fee of ten dollars. Renewal fee for each succeeding year shall be five dollars. There shall be paid for each apprentice indentured to or working for a licensed radio serviceman a fee of five dollars each year. All fees shall be due and payable on the first day of May in each year and shall be paid to the City Treasurer. . . .

(6) Revocation of License. License may be revoked by the Board of Examiners of Radio Servicemen for any of the following reasons: (a) Habitual drunkenness or the use of narcotics; (b) Conviction of a crime involving moral turpitude; (c) adjudication of insanity; (d) fraud in obtaining license; (e) if the licensee has defrauded any person for whom he has rendered or has been requested to render service. . . .

The licensee shall have the right to appear before the Board of Examiners of Radio Servicemen to answer the charges made and present testimony in his own defense. . . .

(7) Supervision by Electrical Inspector. The Electrical Inspector shall have general supervision over the enforcement of this ordinance. He shall inspect the installation of radios, public address systems, aerial and ground systems, or any electronic device or apparatus in any public or commercial building. He shall have the right to enter any radio or electronic repair shop during reasonable hours to inspect repair work. He shall have the right to inspect, condemn and order removed any installation or equipment that may entail a distinct hazard to life and property as set forth in the Wisconsin State Electrical Code, and to order such work repaired or changed within fifteen days or any longer period specified by the Electrical Inspector in his written notice to the owner of said equipment.

(8) Exceptions. No license shall be required to test radio tubes or for sales demonstrations or for removing or installing radio tubes. No license shall be required of an owner to install his own aerial or repair his own radio or electronic equipment, provided that no exposed terminals or any wiring outside of the radio set carrying a potential in the excess of thirty volts is installed.

(9) Permits for Loud-speaker and Television Installations. License for Sound Cars or Trucks. There shall be no permanent installation of public address systems or permanent installations of radio and radio signaling systems using microphones, tubes, amplifiers and speakers or any electronic equipment in public or commercial buildings without first obtaining a permit and depositing a permit fee of one dollar. . . .

Temporary installations of public address systems may be made by servicemen without payment of a fee provided notice is given to the electrical inspector prior to the commencement of such installation. . . .





**HALF THE SIZE!  
and twice as good!**

**R**EMEMBER back in pre-war days when anything less than an exact duplicate condenser replacement simply wouldn't do? Condensers were big as half a pound of butter and weighed almost as much. Today, you can replace any of those old "giants" with a Sprague Atom midget dry electrolytic less than half its size—and twice as dependable by any electrical standard of comparison you care to name. What's more, compare Atoms with any similar midgets and you will find they are smaller than most—and far and away the most dependable of the lot!

**Sprague Products Company, North Adams, Mass.**  
(Jobbing Sales Organization for Products of the Sprague Electric Co.)

**TRADING POST  
ON PAGE 80**

Sprague's free wartime Advertising service, THE TRADING POST, also appears in this issue—and will continue to appear as long as it can be of help to our thousands of friends throughout the trade.



# SPRAGUE ATOMS



**THE IDEAL REPLACEMENTS FOR ALL DRY ELECTROLYTIC CAPACITOR TYPES**



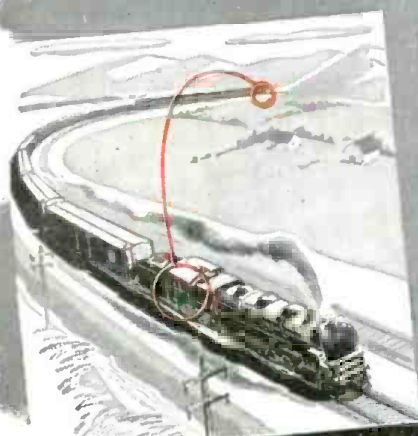

ENGINEER TO CABOOSE

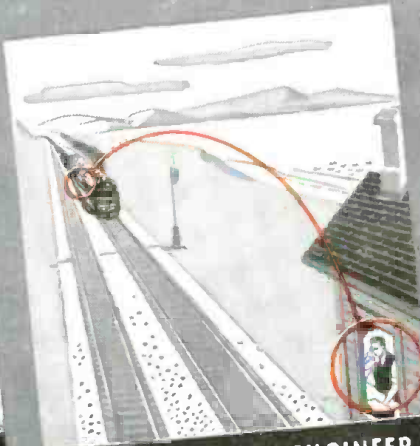

YARDMASTER TO ENGINEER

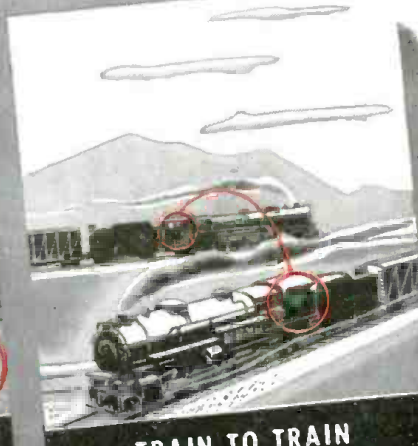

TRAIN TO TRAIN

TRAIN TALK THAT COUNTS ... WITH

# Motorola **F-M** Radio



Photo shows yardmaster in Blue Island Yards of Rock Island Lines using his F-M two-way Motorola Radiotelephone to talk to freight engineer in his moving Diesel locomotive twenty-five miles away.

When your railroad engineer talks at will to the brakeman or conductor in the caboose; and the yardmaster or train dispatcher in his office speaks directly to the engineer in his speeding cab; and the engineers of moving trains talk to each other, **THAT'S TRAIN TALK THAT COUNTS.**

This two-way radio communications obtained by the **MOTOROLA F-M Two-way Radio telephone system counts** in efficiency, economy and safety, three vital essentials in any business, but doubly important to railways.

**MOTOROLA RADIO** engineers are noted not only for the famous "Handie-Talkie" (a Motorola Radio First), the fighting two-way radio used by our armed forces on every battle-front but they are also noted for their famous two and three-way police radiotelephone systems installed in 26 States and over 500 communities throughout the United States, the Canal Zone and Hawaii,

For complete details on a Motorola Radiotelephone system for **YOUR** railroad, write to:

**GALVIN** MFG. CORPORATION • CHICAGO 51

E-M & A-M HOME RADIO • AUTO RADIO • AUTOMATIC PHONOGRAPH • TELEVISION • F-M POLICE RADIO • RADAR • MILITARY RADIO